

INSTRUCTIONS CM308E

© Panduit Corp. 2014

PART NUMBERS

VERTICAL CABLE MANAGEMENT		Mounting Kits (sold separately)	Racks	
Front/Rear	Front Only			
		WMPVCBE (Center Mount) (Standard mounting for Panduit 2 and 4 post racks. One kit Included.)	CMR19X47 CMR19X84 CMR19X84NU CMR23X84	CMR19X84S R4P Series of 4 Post Racks CMR4P84 series of 4 Post Racks 3" Deep R2P series of 2 Post Racks
WMPV22E WMPV45E WMPVHC45E	WMPVF22E WMPVF45E WMPVHCF45E	WMPVSMK (Side Mount) (Optional Mounting for Panduit 4 post racks and CMR19X84S)		NFR84 CMR19X84S R4P Series of 4 Post Racks CMR4P84 series of 4 Post Racks



WMPV45E



WMPV22E

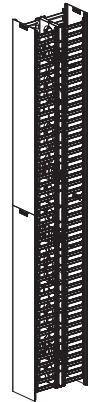

WMPVHC45E

Location Guide for Center Mounting (CMR19X84 with WMPVCBE)

Dimensions in () parenthesis are for 6" Vertical Cable Management

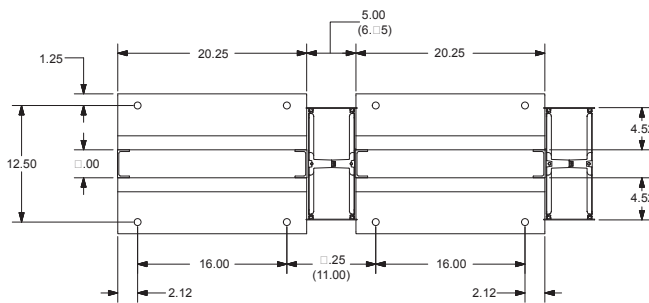

Bracket Installation

1

Note:

When installing between two racks use part number **WMPVCBE** for the additional brackets required. Bracket is keyed to be installed in the correct orientation.

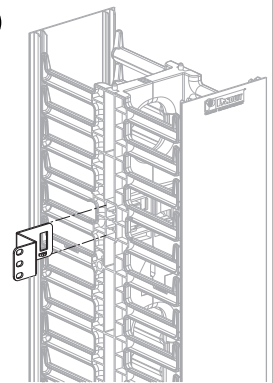

Standard Rack Installation

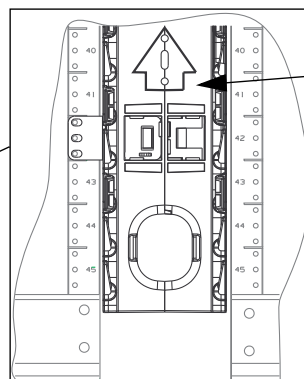
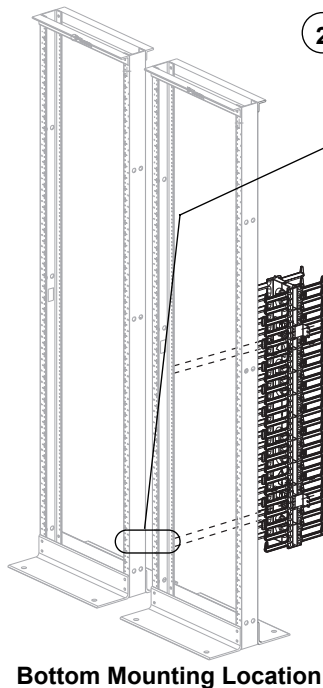

Rear Bottom Mounting Location

Note:

Arrows and flags must point upward

4

#12-24 Screws

Location pin(s)

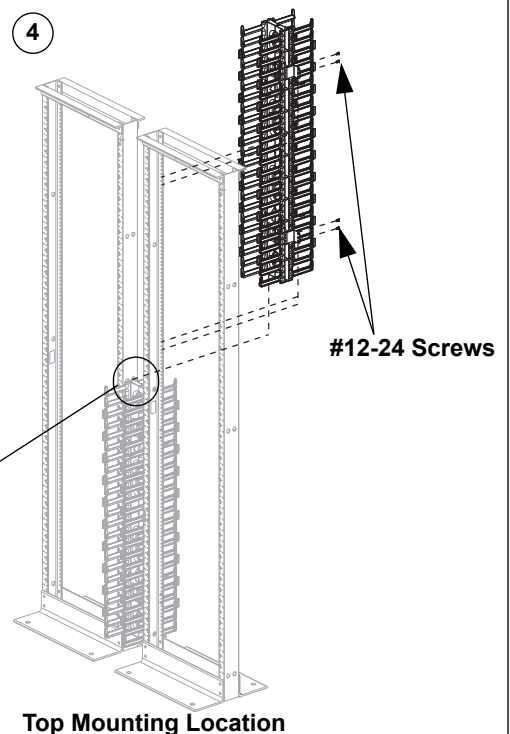

FOR TECHNICAL SUPPORT www.panduit.com/resources/install_maintain.asp

INSTRUCTIONS CM308E

Installation Instructions NFR84 using WMPVSMK side mounting kit

Note: Mount the racks to the floor (with the appropriate space between racks indicated in the chart below)

Part Number	Space
WMPV22E WMPV45E WMPVF22E WMPVF45E	5"
WMPVHC45E WMPVHCF45E	6.75"

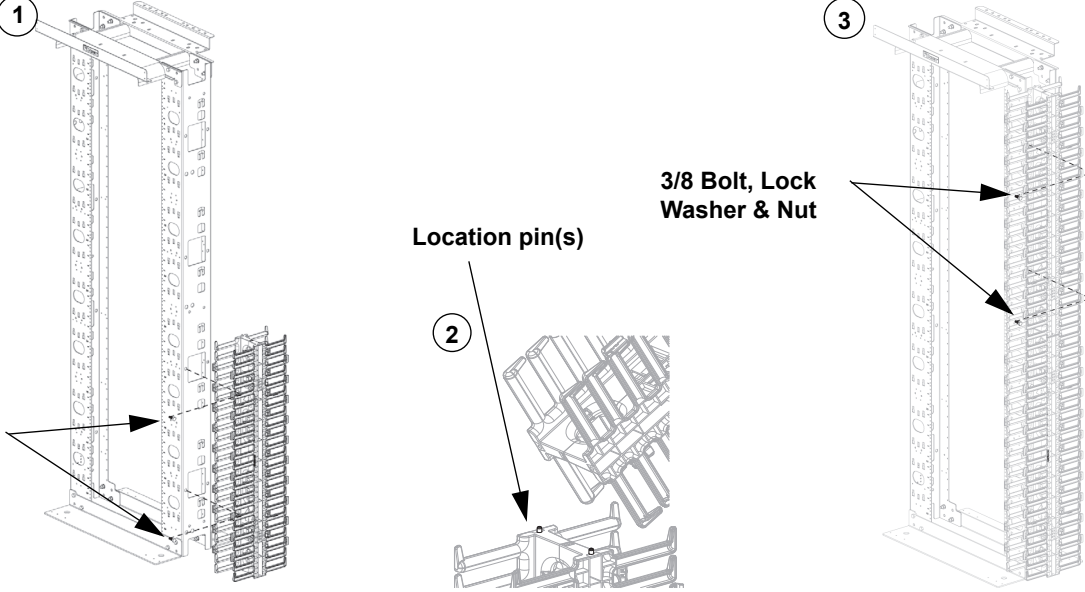

3/8 Bolt, Lock Washer & Nut

Location pin(s)

3/8 Bolt, Lock Washer & Nut

Opening and Closing Cover

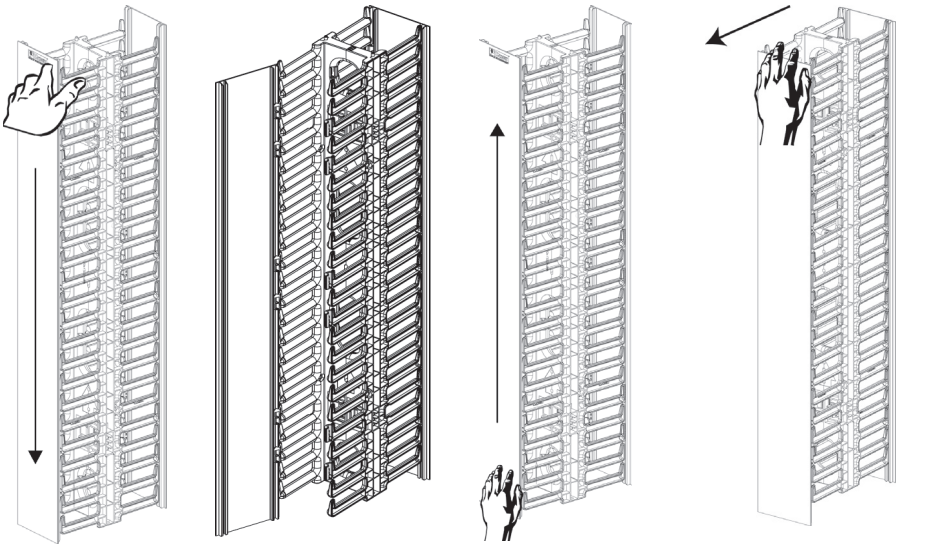

Opening **Open** **Closing** **Removal**

Wire Retainer Installation (WR5E)

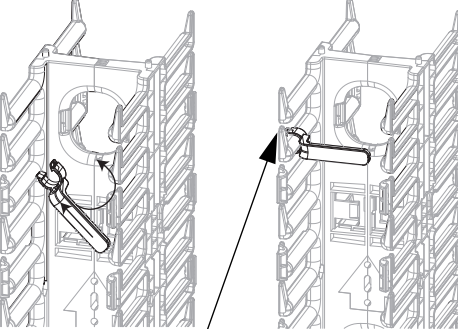

Use thumb to release wire retainer for removal

CABLE CAPACITY CHART*

Part Number	UTP Cable .187" dia.		ScTP or CAT 6 Cable .25" dia.		Channel Area	
	Front	Back	Front	Back	Front	Back
WMPVHC45E	475	475	265	265	32.7	32.7
WMPVHCF45E	475	-	265	-	32.7	-
WMPV22E	270	270	150	150	18.5	18.5
WMPV45E	270	270	150	150	18.5	18.5
WMPVF22E	270	-	150	-	18.5	-
WMPVF45E	270	-	150	-	18.5	-

NOTE: These capacity estimates represent the maximum number of cables that can be routed through the NetRunner™ vertical channels in an ideal vertical pass-through application. These figures do not account for routing inefficiencies such as cable bundling, slack management, and the entrance/exit of cables through the finger slot openings.

*Capacity = $\frac{\text{Channel Area}}{\text{Area of One Cable}} \times 40\% \text{ Fill Factor}$

For instructions in Local Languages and Technical Support:

www.panduit.com/resources/install_maintain.asp



www.panduit.com

E-mail:

techsupport@panduit.com

Fax:

(866)405-6654