



SANYO Semiconductors

DATA SHEET

An ON Semiconductor Company

LV49821VH — Bi-CMOS IC For Portable Electronic Device Use 1.4W × 2ch BTL Power Amplifier

Overview

The LV49821VH incorporates a 2-channel power circuit amplifier capable of low-voltage operation (2.7V and up). It has a function for switching the headphone driver and also has a standby function to reduce the current drain. It is a power amplifier IC optimal for driving the speakers used in portable equipment and low power output equipment.

Use

- Portable DVD-player, Note PC, Portable TV, LCD monitor, Active speaker, and more.

Features

- 2-channels BTL power amplifier built-in: Standard output power = 1.4W ($V_{CC} = 5V$, $R_L = 8\Omega$, THD = 10%)
Output coupling capacitor is unnecessary because of differential output type.
- Standby function built-in: Standard standby current = 0.01 μ A ($V_{CC} = 5V$)
- Second amplifier stop control function built-in: Headphone driver switch (for BTL/SE switch)
Audio mute (Only BTL power amplifier path)
- Supports beep signal input
- Thermal protection circuit built-in
- Operation at low voltage possible: $V_{CC} = 2.7V$ to 5.5V
- Gain setting possible: BTL voltage gain = 0 to 26dB

Specifications

Maximum Ratings at $T_a = 25^\circ\text{C}$

Parameter	Symbol	Conditions	Ratings	Unit
Maximum supply voltage	VCC max		6	V
Allowable power dissipation	Pd max	Mounted on a specified board.*	1.5	W
Maximum junction temperature	Tj max		150	$^\circ\text{C}$
Operating temperature	Topr		-30 to +75	$^\circ\text{C}$
Storage temperature	Tstg		-40 to +150	$^\circ\text{C}$

* Specified board (SANYO Semiconductor Evaluation board): 70mm × 70mm × 1.6mm, glass epoxy both side.

■ Any and all SANYO Semiconductor Co.,Ltd. products described or contained herein are, with regard to "standard application", intended for the use as general electronics equipment (home appliances, AV equipment, communication device, office equipment, industrial equipment etc.). The products mentioned herein shall not be intended for use for any "special application" (medical equipment whose purpose is to sustain life, aerospace instrument, nuclear control device, burning appliances, transportation machine, traffic signal system, safety equipment etc.) that shall require extremely high level of reliability and can directly threaten human lives in case of failure or malfunction of the product or may cause harm to human bodies, nor shall they grant any guarantee thereof. If you should intend to use our products for applications outside the standard applications of our customer who is considering such use and/or outside the scope of our intended standard applications, please consult with us prior to the intended use. If there is no consultation or inquiry before the intended use, our customer shall be solely responsible for the use.

■ Specifications of any and all SANYO Semiconductor Co.,Ltd. products described or contained herein stipulate the performance, characteristics, and functions of the described products in the independent state, and are not guarantees of the performance, characteristics, and functions of the described products as mounted in the customer's products or equipment. To verify symptoms and states that cannot be evaluated in an independent device, the customer should always evaluate and test devices mounted in the customer's products or equipment.

SANYO Semiconductor Co., Ltd.

www.semicon.sanyo.com/en/network

LV49821VH

Operating Conditions at $T_a = 25^\circ\text{C}$

Parameter	Symbol	Conditions	Ratings	Unit
Recommended supply voltage	V_{CC}		5	V
Recommended load resistance	R_L		4 to 32	Ω
Operation supply voltage range	V_{CC} op1	$R_L = 8\Omega$ or more	2.7 to 5.5	V
	V_{CC} op2	$R_L = 4\Omega$ or 6Ω	2.7 to 3.7	V

Note : Please determine supply voltage used with due consideration of allowable power dissipation.

Electrical Characteristics at $T_a = 25^\circ\text{C}$, $V_{CC} = 5\text{V}$, $f_{in} = 1\text{kHz}$, $R_L = 8\Omega$, $V_2 = \text{high}$, $V_6 = \text{Low}$

Parameter	Symbol	Conditions	Ratings			Unit
			min	typ	max	
Quiescent current	I_{CCOP1}	No signal, $R_L = \infty$		7.1	13	mA
	I_{CCOP2}	No signal, $R_L = \infty$, $V_6 = \text{High}$ (2nd amplifier stop)		4.0		mA
Standby current	I_{STBY}	No signal, $R_L = \infty$, $V_2 = \text{Low}$ (Standby mode)		0.01	10	μA
Maximum output power	P_O max	THD = 10%	0.91	1.4		W
Voltage gain	V_G	$V_{in} = -25\text{dBV}$	17.6	19.1	20.6	dB
Voltage gain difference	V_{GR}		0		26	dB
Channel balance	CHB	$V_{in} = -25\text{dBV}$	-1.5	0	+1.5	dB
Total harmonic distortion	THD	$V_{in} = -25\text{dBV}$		0.3	1	%
Output noise voltage	V_{NO}	$R_g = 620\Omega$, 20 to 20kHz		35	100	μV_{rms}
Channel separation	CHsep	$V_{out} = -25\text{dBV}$, 20 to 20kHz	50	60		dB
Output offset voltage	V_{DCOS}	$R_g = 620\Omega$	-30		+30	mV
Muting attenuation level	MUTE1	$V_{in} = 0\text{dBV}$, $V_2 = \text{Low}$ (Standby mode)		-110		dBV
	MUTE2	$V_{in} = -10\text{dBV}$, $V_6 = \text{High}$ (2nd amplifier stop)		-85		dBV
Ripple rejection ratio	SVRR	$R_g = 620\Omega$, $f_r = 100\text{Hz}$, $V_r = -20\text{dBV}$		35		dB
Reference Voltage (pin 4)	V_{ref}			2.5		V
High level control voltage (pin 2)	V_{STBH}	Power amplifier operation mode	1.6		V_{CC}	V
Low level control voltage (pin 2)	V_{STBL}	Power amplifier standby mode	0		0.3	V
High level control voltage (pin 6)	V_{2CNTH}	2nd amplifier standby mode (SE mode)	$4V_{CC}/5$		V_{CC}	V
Low level control voltage (pin 6)	V_{2CNTL}	2nd amplifier operation mode (BTL mode)	0		$V_{CC}/2$	V

Package Dimensions

unit : mm (typ)

3377

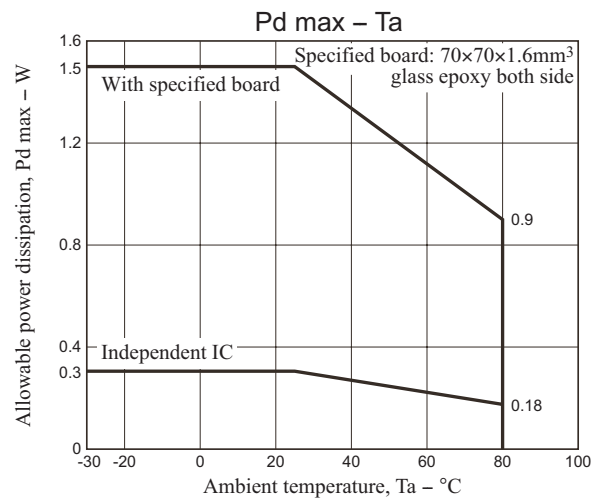
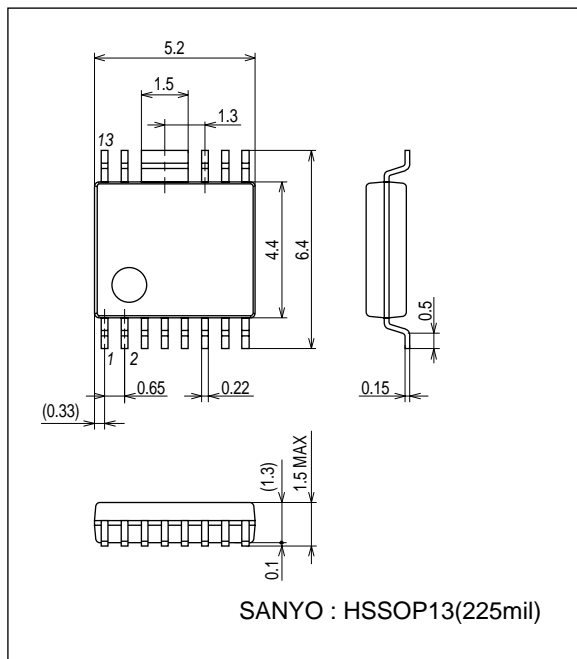

LV49821VH

Block Diagram

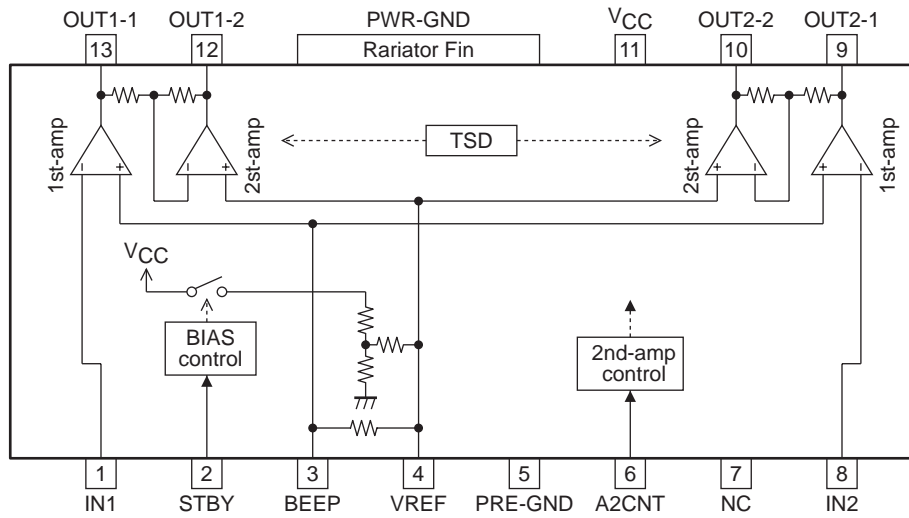

Test Circuit

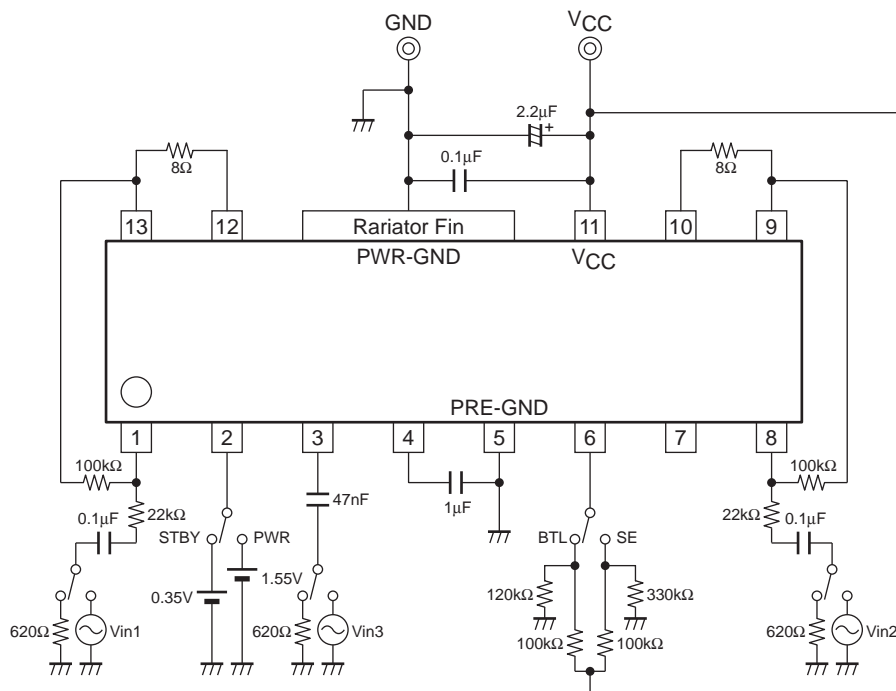

LV49821VH

Evaluation Board Circuit

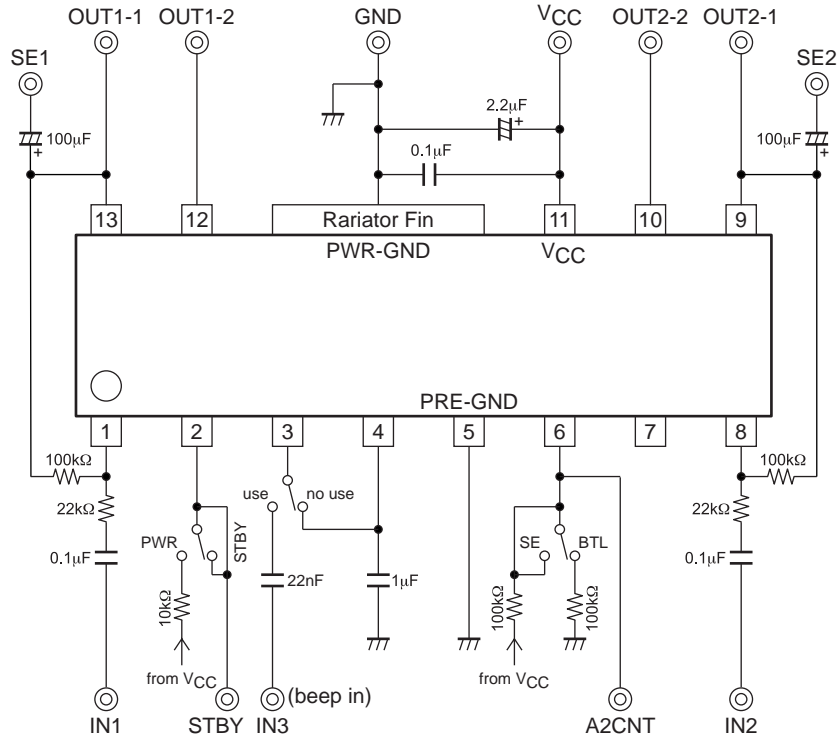

Evaluation Board Layout (70mm × 70mm × 1.6mm)

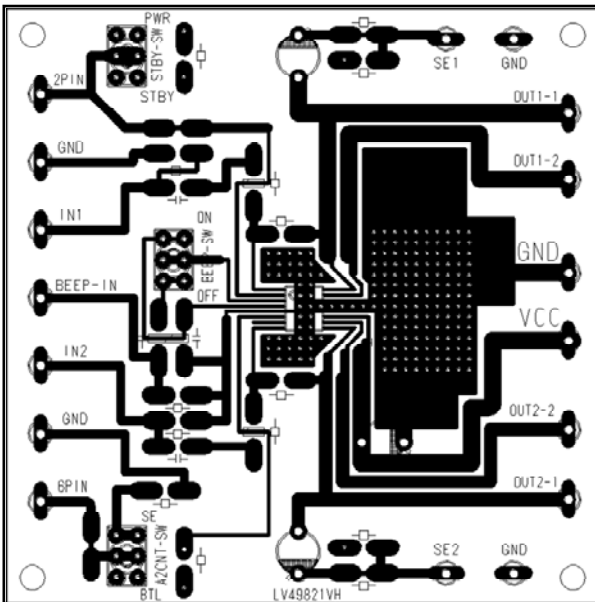

Top layer

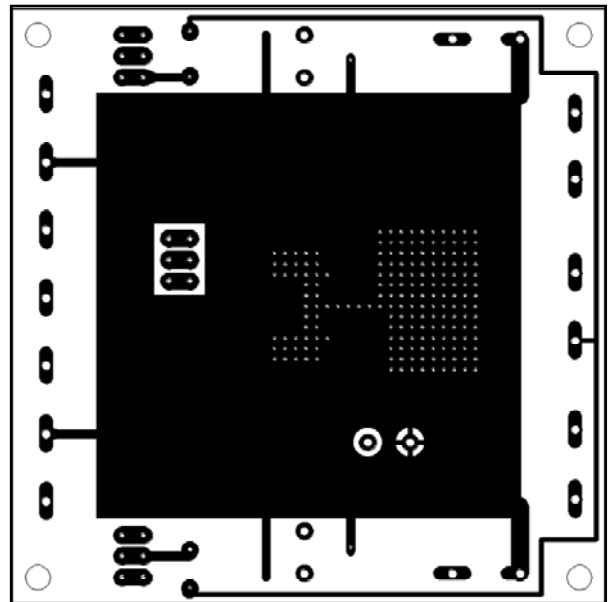

Bottom Layer

LV49821VH

Pin Function

Pin No.	Pin name	Pin voltage $V_{CC} = 5V$	Function	Equivalent circuit
1 8	IN1 IN2	2.5V 2.5V	Power amplifier input pin (1ch). Power amplifier input pin (2ch).	
2	STBY	External apply	Standby control pin. <ul style="list-style-type: none"> Standby mode (0 to 0.3V) Operation mode (1.6V to V_{CC}) 	
3 4	BEEP VREF	2.5V 2.5V	Beep signal input pin. Reference voltage pin.	
5	PRE-GND	0V	Pre-stage block ground pin	
6	A2CNT	External apply	2nd amplifier stop control pin.	
7	NC	-	Unused pin.	
9 13	OUT2-1 OUT1-1	2.5V 2.5V	BTL 1st output pin (2ch). BTL 1st output pin (1ch).	
10 12	OUT2-2 OUT1-2	2.5V 2.5V	BTL 2nd output pin (2ch). BTL 2nd output pin (1ch).	
11	V_{CC}	External apply	Power supply pin.	
FIN	PWR-GND	0V	Power system ground pin, Radiation fin.	

Usage Note

1. Input coupling capacitor (C1 and C2)

C1 and C2 are input coupling capacitors that are used to cut the DC component. The input coupling capacitors C1, C2 and the input resistors R1 and R3 make up the high-pass filter, attenuating the bass frequency. Therefore, the capacitance value must be selected with due consideration of the cut-off frequency.

The cut-off frequencies are expressed by the following formulas.

$$1\text{ch} \Rightarrow fc1 = 1/(2\pi \times C1 \times R1)$$

$$2\text{ch} \Rightarrow fc2 = 1/(2\pi \times C2 \times R3)$$

This capacitor affects the pop sound at startup. Note with care that increasing the capacitance value lengthens the charging time of the capacitor, which will make the pop sound louder.

2. BTL voltage gain

The voltage gain of the first amplifier is determined by the ratio between the resistors R1 and R2 (R3 and R4).

$$1\text{ch} \Rightarrow Vg1 = 20 \times \log(R2/R1) \dots \text{unit: dB}$$

$$2\text{ch} \Rightarrow Vg2 = 20 \times \log(R4/R3) \dots \text{unit: dB}$$

Therefore, the BTL voltage gain is expressed by the following formulas.

$$1\text{ch} \Rightarrow VgBTL1 = 6 + 20 \times \log(R2/R1) \dots \text{unit: dB}$$

$$2\text{ch} \Rightarrow VgBTL2 = 6 + 20 \times \log(R4/R3) \dots \text{unit: dB}$$

The BTL voltage gain must be set in the range of 0 to 26 dB.

3. Beep signal input pin (pin 3)

This pin is connected to the non-inverting input block of the first amplifier of the BTL amplifier, and is biased internally by a 50kΩ resistor. The input coupling capacitor C4 and the bias resistor make up a high-pass filter that attenuates bass band signals, so when determining the C4 capacitance value, the value must be set with due consideration of the cut-off frequency. The cut-off frequency is expressed by the following formula.

$$fc3 = 1/(2\pi \times C4 \times 50000)$$

In addition, when input from Pin 3, the BTL voltage gain is expressed by the following formulas.

$$1\text{ch} \Rightarrow VgBTL1 = 6 + 20 \times \log(1+R2/(R1 + ro)) \dots \text{unit: dB}$$

$$2\text{ch} \Rightarrow VgBTL2 = 6 + 20 \times \log(1+R4/(R3 + ro)) \dots \text{unit: dB}$$

When setting the signal level, the signal should be attenuated and input as shown in Fig.1.

When not using this input pin, connect it to pin 4 as shown in Application Circuit Example-2.

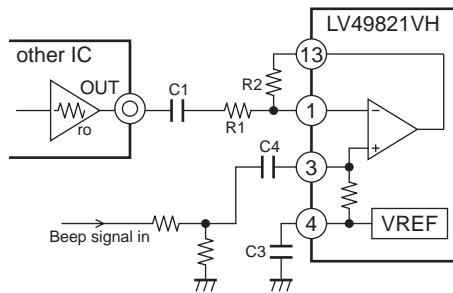

Fig.1

4. pin 4 capacitor (C3)

This capacitor is a ripple filter capacitor. The internal resistors (100kΩ + 450kΩ) and C3 make up a low-pass filter that is used to reduce the power supply ripple component and increase the ripple rejection ratio.

Note that inside the IC, the rising-transient-response-characteristic of the pin 4 voltage (reference voltage) is used to activate the automatic pop sound reduction circuit. Therefore, when reducing the C3 capacitance value to increase the voltage rise speed, the design should take into account that the pop sound increases during voltage rise.

5. Power supply line capacitor (C7 and C8)

The bypass capacitor C8 is used to remove the high frequency component that cannot be eliminated by the power supply capacitor C7 (chemical capacitor). Place the bypass capacitor C8 as near to the IC as possible, and use a ceramic capacitor with good high frequency characteristics.

When using a stabilized power supply, these capacitors can also be combined into a single 2.2μF ceramic capacitor.

Note that when the power supply line is relatively unstable, the power supply capacitor C7 capacitance value must be increased.

6. Standby pin (pin 2)

By controlling the standby pin, the mode changeover can be made between standby and operation modes. Direct control is possible using the CPU output port, but inserting a series resistor R5 (1 kΩ or more) is recommended in case the pin is affected by digital noise from the CPU.

Standby mode ... V2 = 0V to 0.3V

Operating mode... V2 = 1.6V to VCC

In addition, when not using standby mode, this pin can also be used interlocked with the power supply as shown in Fig. 2. The series resistor R5 can be eliminated, but the current I2 expressed by the following formula flows through the standby pin, so this should be taken into account in the design.

$$\text{Pin 2 inflow current (unit: A): } I_2 = 7 \times 10^{-6} + (V_{CC} - 0.7) / (R_5 + 30000)$$

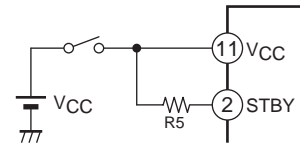

Fig.2

7. Pin 6 control (2nd amplifier stop control function)

Pin 6 performs on/off control for the BTL amplifier's second amplifier operation. This function enables switching between speaker drive (BTL output system) and headphone drive (single end output system). The control comparator is connected to this pin, and this threshold voltage is generated by resistance division from the supply voltage. For this reason, care should be taken, as the threshold value varies according to the supply voltage. When switching using a headphone jack switch, the connection method shown in Application Circuit Example-1 is recommended.

Comparator threshold value: $V_{th} = V_{CC} \times 2/3$

In addition, when controlling this pin with the CPU (BTL amplifier mute function), care should be taken for the relationship between the supply voltage used by the CPU and the supply voltage used by the power amplifier IC. When the supply voltage used by the power amplifier IC is higher, open/low format control as shown in Fig.3 and Fig.4 is recommended. In addition, there is also a control method that uses three resistors as shown in Fig.5. The recommended ratio between the resistance values of these three resistors is as follows.

RC1, RC2, RC3 resistance ratio ... RC1 : RC2 : RC3 = 1 : 1 : 3

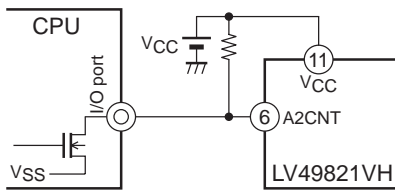

Figure 3

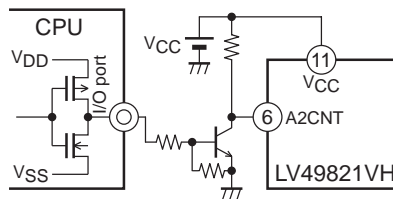

Figure 4

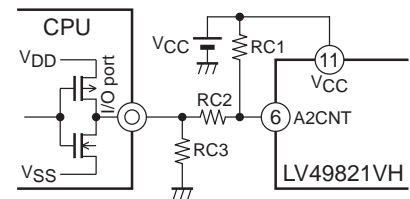

Figure 5

8. Headphone drive

When also using the BTL amplifier's first amplifier as the headphone amplifier, it is recommended to adjust the level by inserting series resistors R6 and R8 to the signal line as shown in Application Circuit Example-1.

Note that this series resistor, the headphone load resistance and the output coupling capacitors C5 and C6 make up a high-pass filter, so this should be taken into account in the design. The cut-off frequencies are expressed by the following formulas.

$$1\text{ch} \Rightarrow fc1 = 1 / (2\pi \times C5 \times (R6 + R_L))$$

$$2\text{ch} \Rightarrow fc2 = 1 / (2\pi \times C6 \times (R8 + R_L))$$

9. Load capacitance

When connecting a capacitor between the output pin and ground to suppress electromagnetic radiation or other purposes, the effects of this capacitor may cause the power amplifier phase margin to be reduced, resulting in oscillation. When adding this capacitor, care should be taken for the capacitance value.

Recommended capacitance value: 0.033μF to 0.33μF

10. Thermal protection circuit

The IC has a built-in thermal protection circuit that can reduce the risk of breakdown or degradation when the IC becomes abnormally hot for some reason. When the internal chip junction temperature Tj rises to approximately 170°C, this protective circuit operates to cut off the power supply to the power amplifier block and stop signal output. Operation recovers automatically when the chip temperature drops to approximately 130°C.

Note that this circuit cannot always prevent breakdown or degradation, so sufficient care should be taken for using the IC. When the chip becomes abnormally hot, immediately turn off the power and determine the cause.

11. Short-circuit between pins

Turning on the power supply with the short-circuit between terminals leads to the deterioration and destruction of IC. When fixing the IC to the substrate, please check that the solder is not short-circuited between the terminals before turning on the power.

12. Load Short-circuit

Leaving the IC in the load short-circuit for many hours leads to the deterioration and destruction of the IC. The load must not be short-circuited absolutely.

13. Maximum rating

When the rated value used is just below to the absolute maximum ratings value, there is a possibility to exceed the maximum rating value with slight extrusion variable. Also, it can be a destructive accident.

Please use within the absolute maximum ratings with sufficient variation margin of supply voltage.

In addition, the package of this IC has low thermal radiation characteristics, so secure sufficient thermal radiation by providing a copper foil land on the printed circuit board near the heat sink.

When $V_{CC} = 5V$ and load = 8Ω , a ground line copper foil area of approximately $50mm \times 50mm$ is recommended.

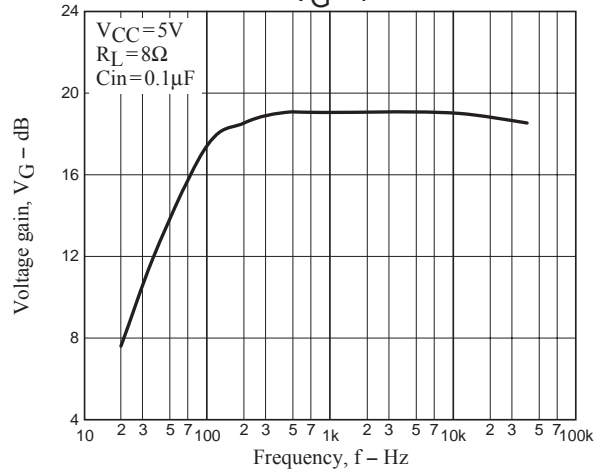
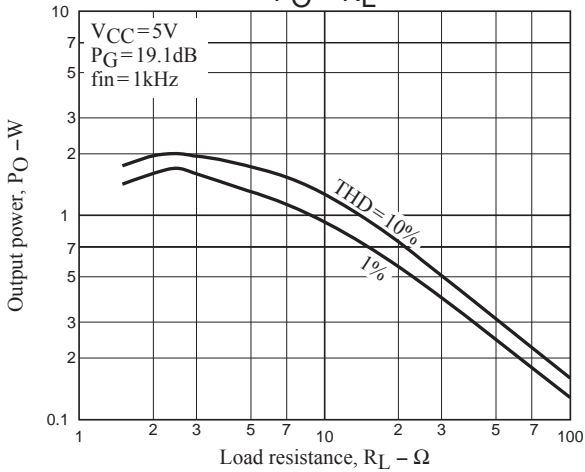
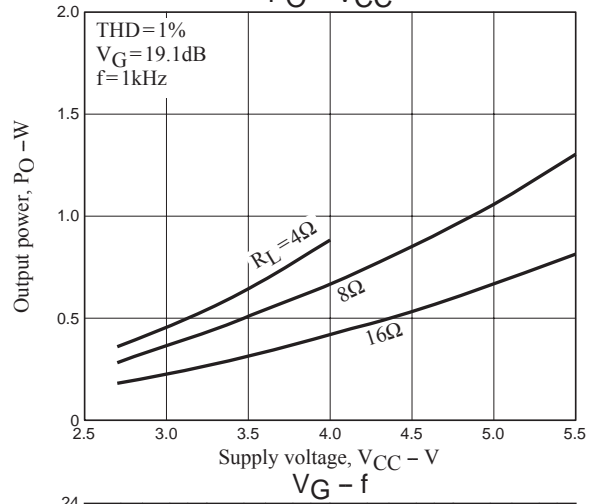
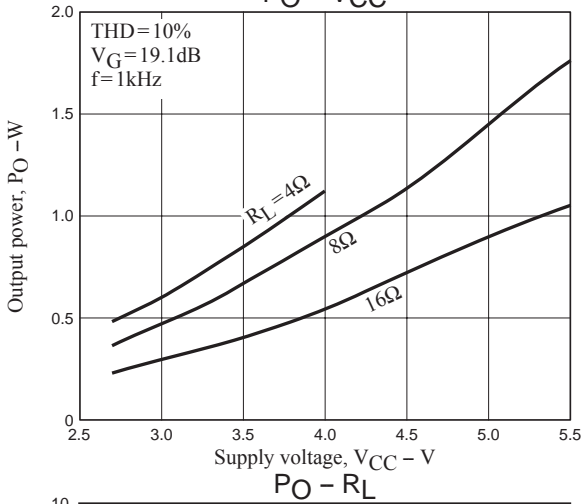
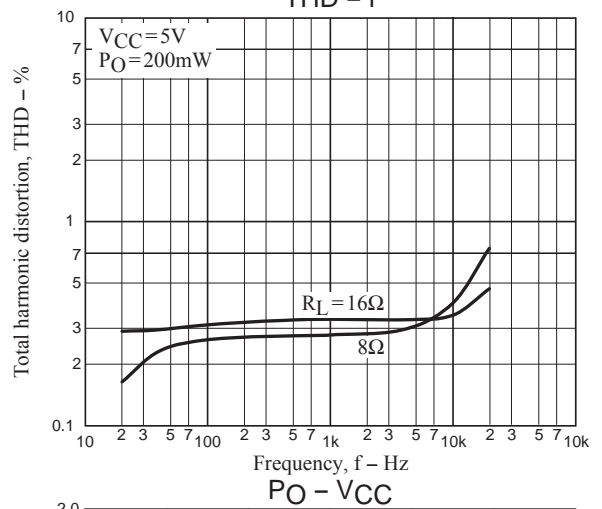
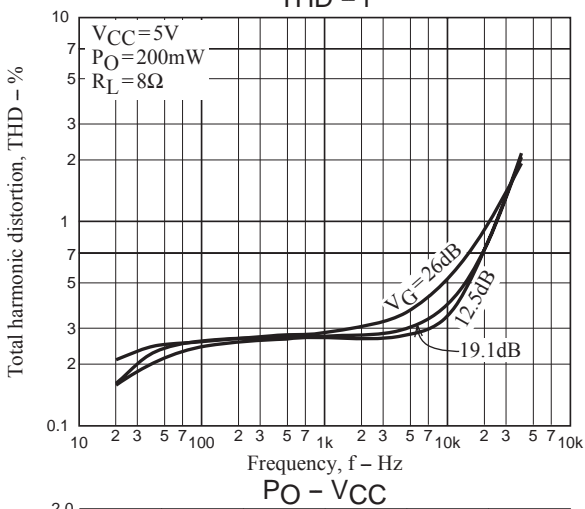
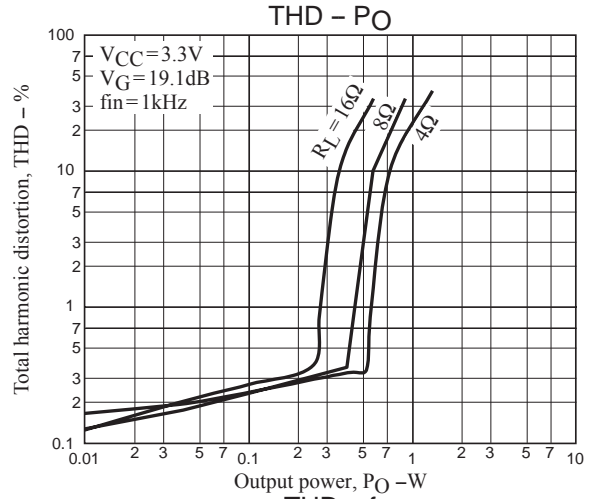
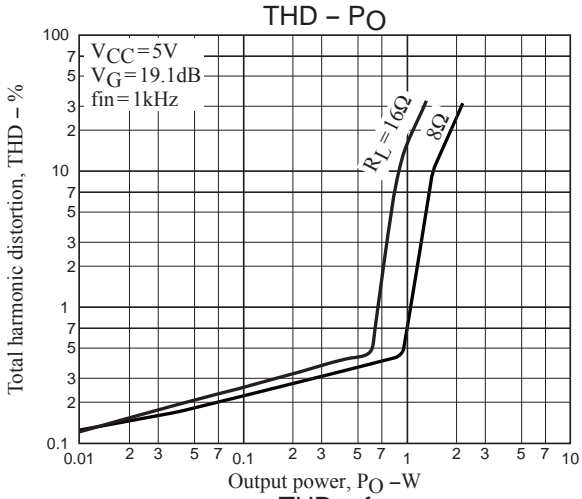

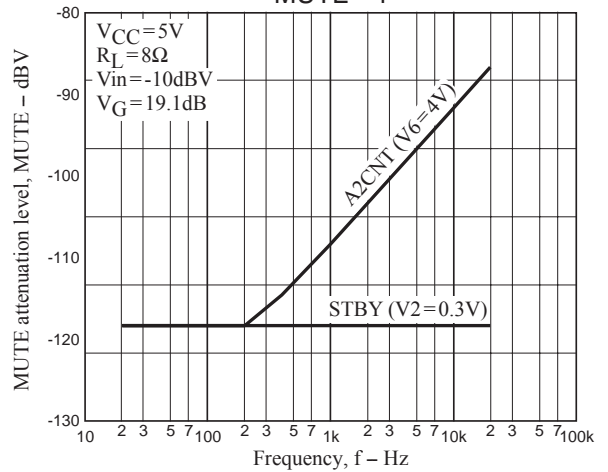
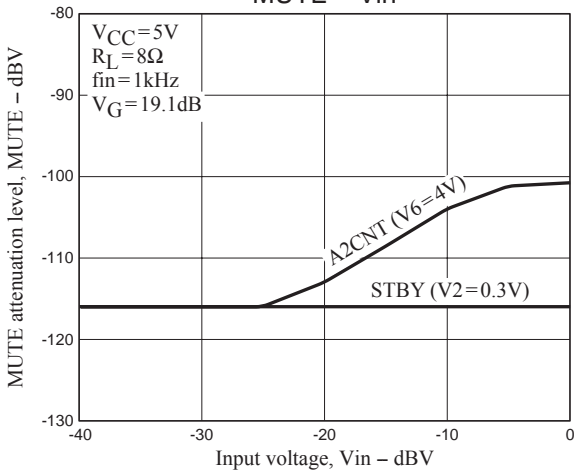
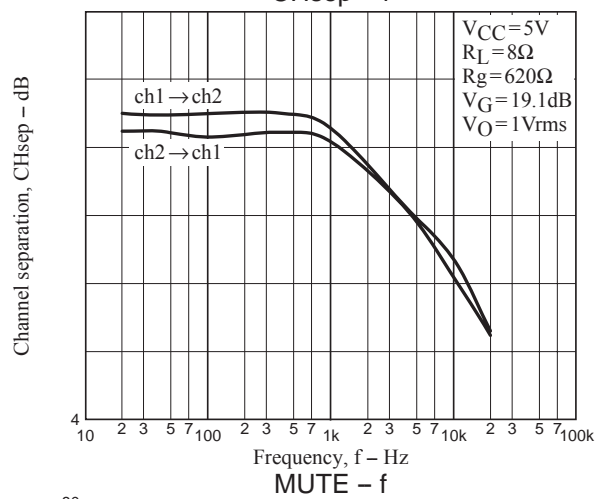
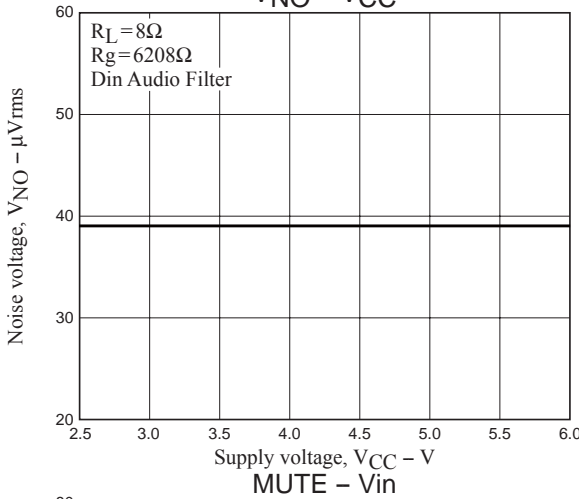
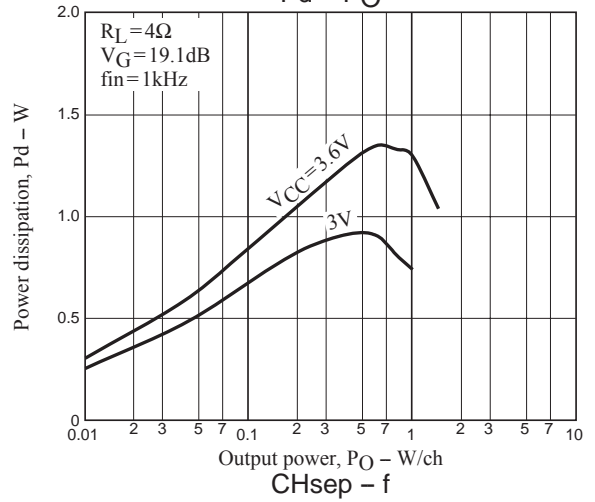
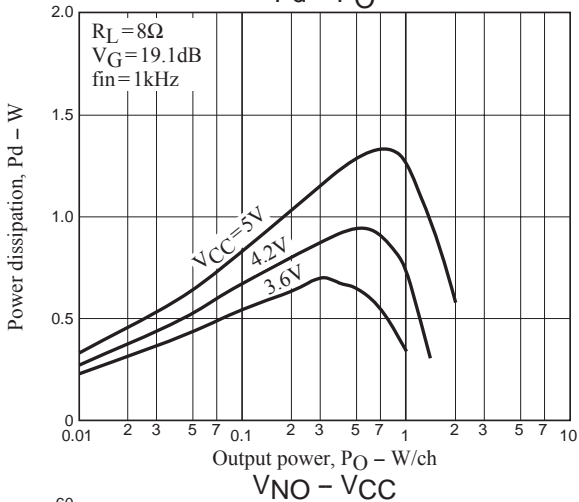
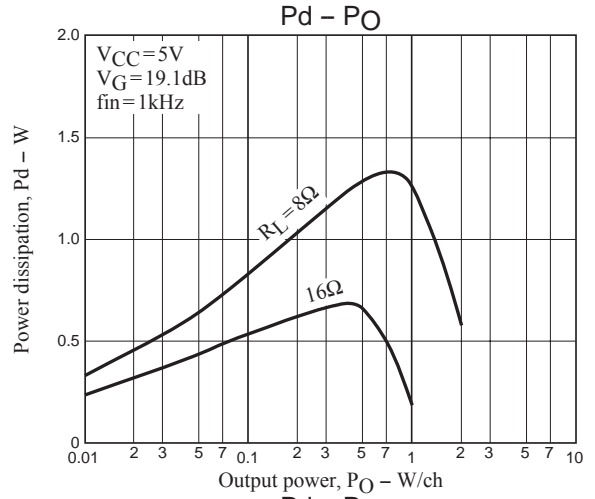
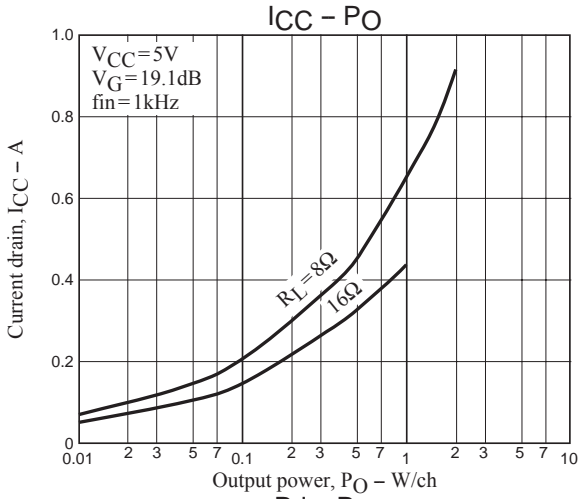

LV49821VH

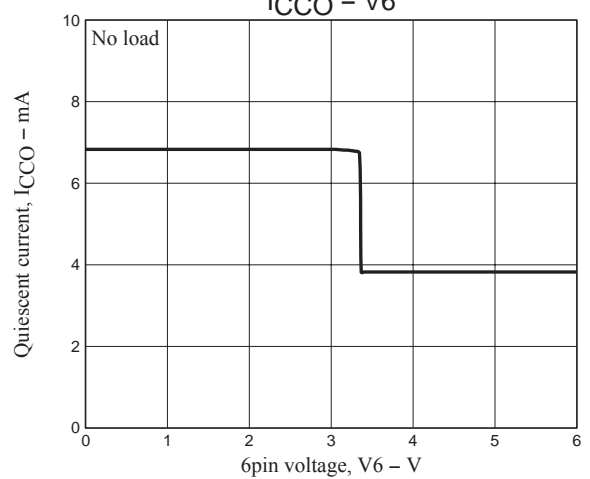
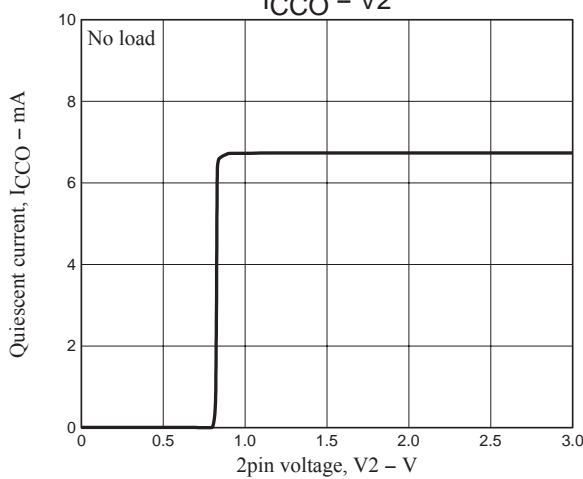
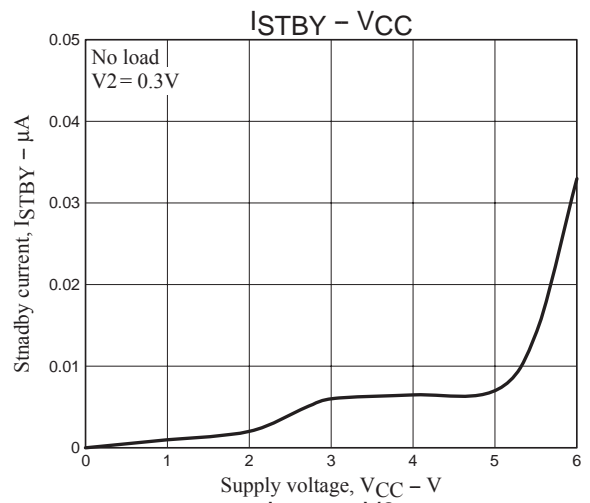
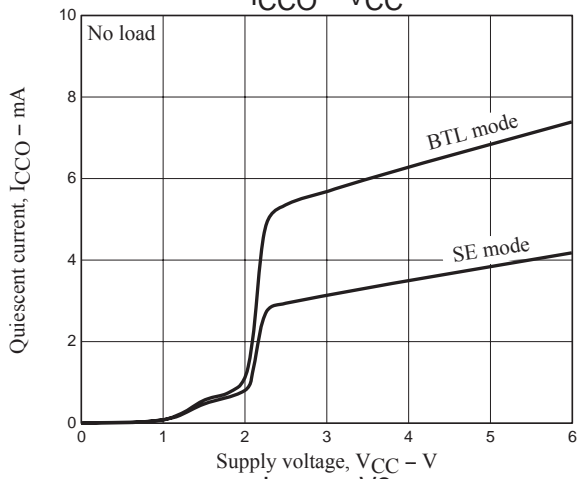
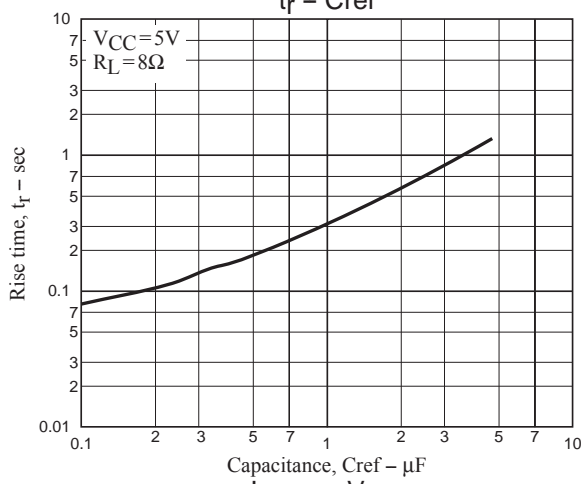
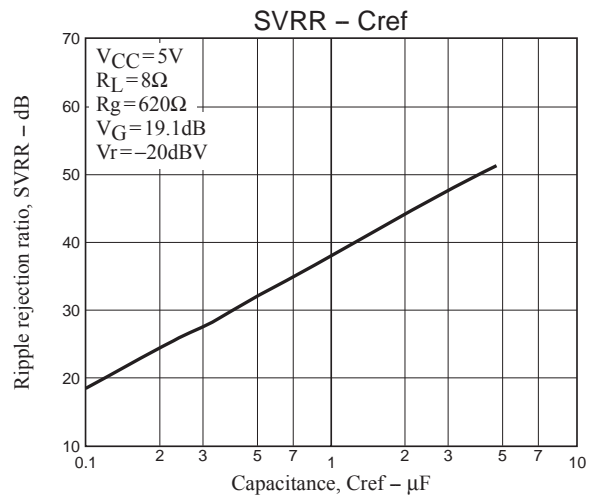
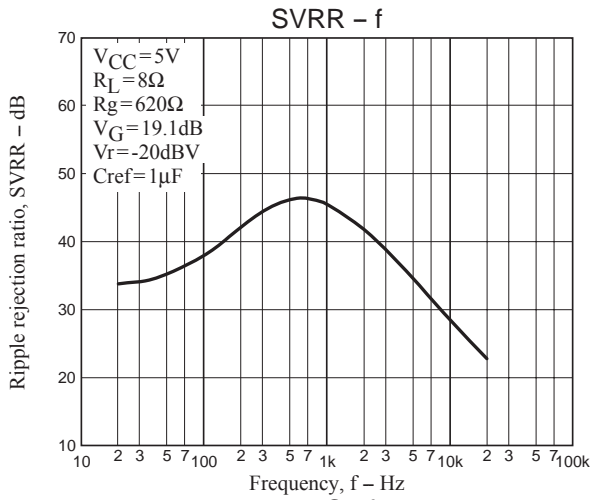

LV49821VH

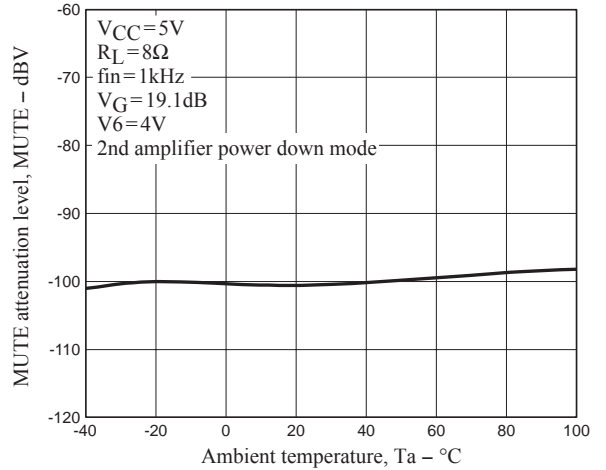
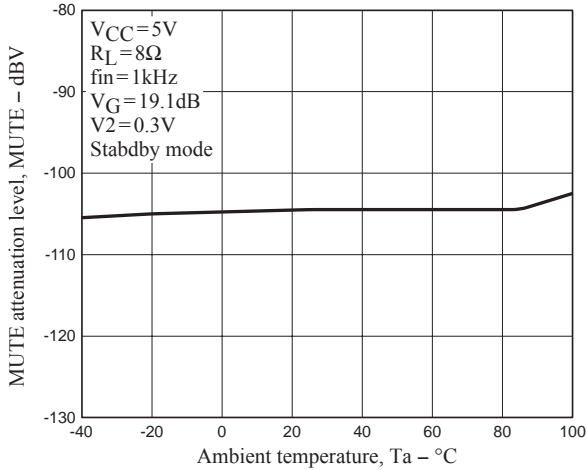
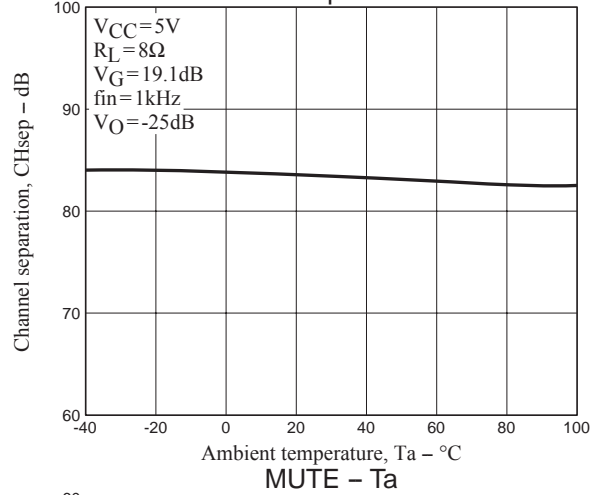
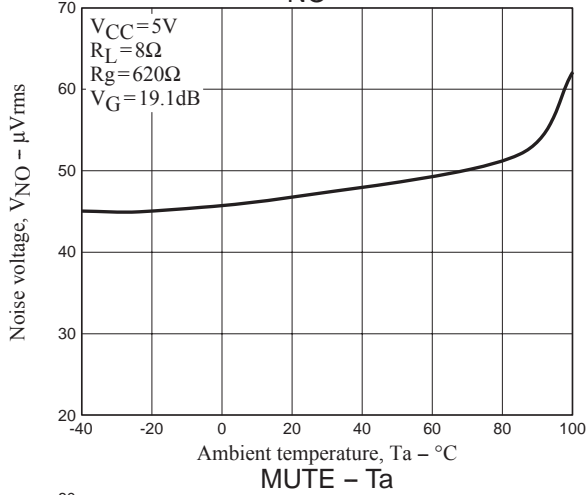
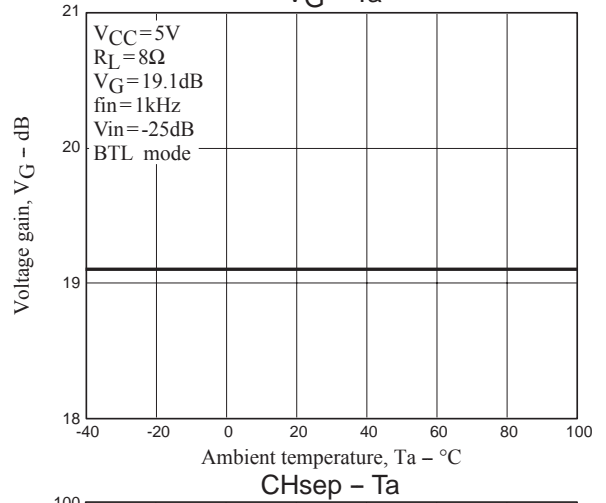
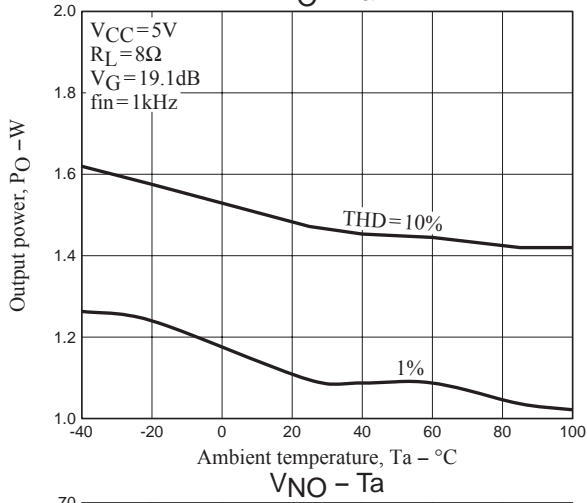
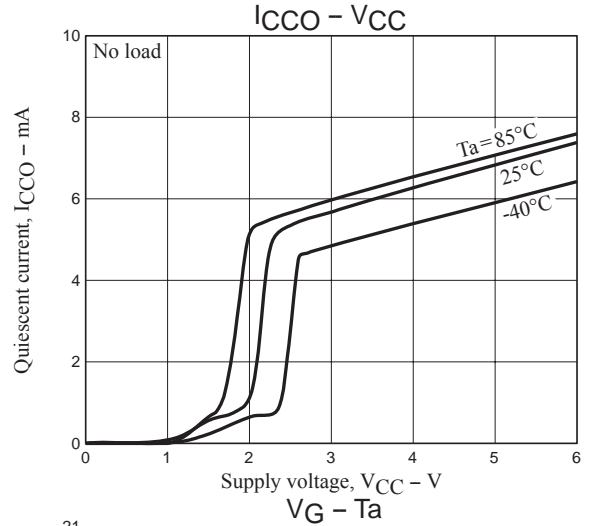
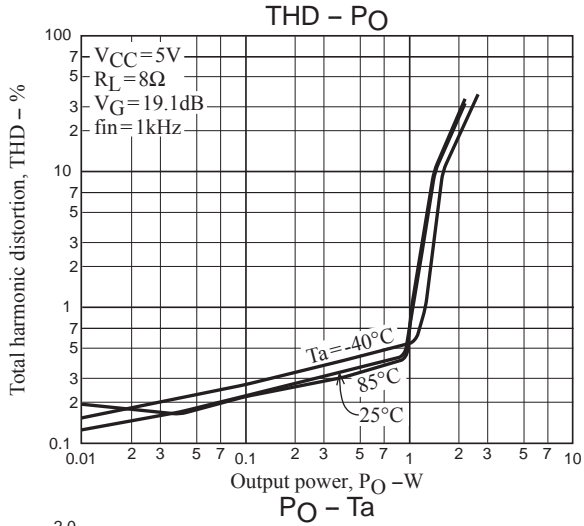

LV49821VH

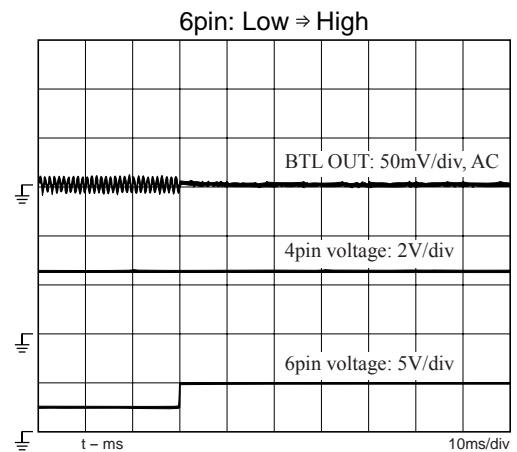
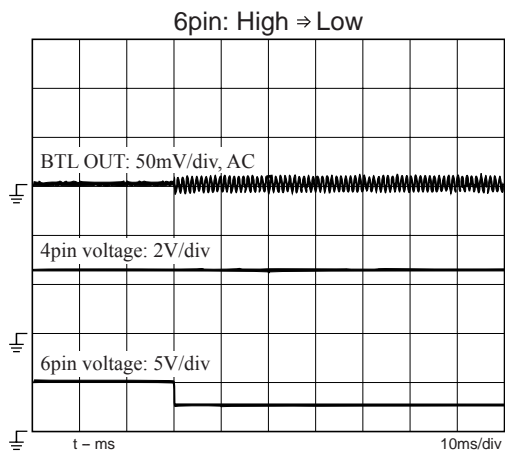
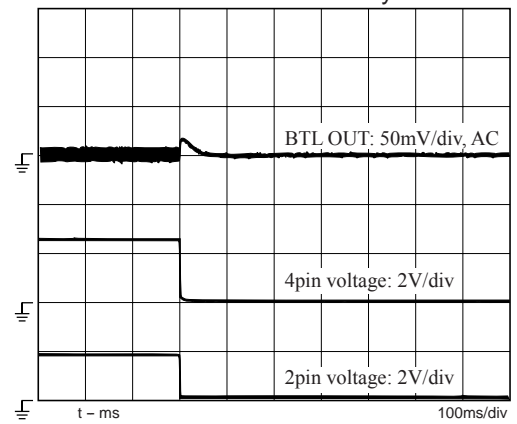
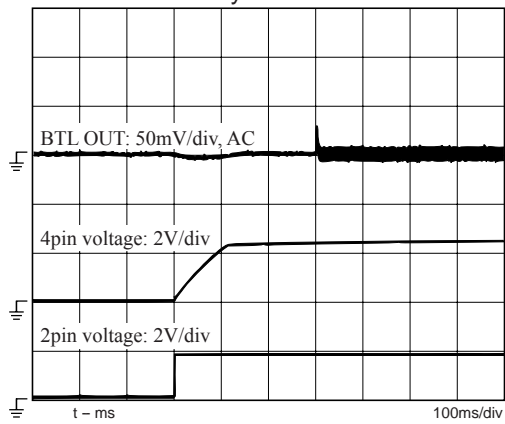
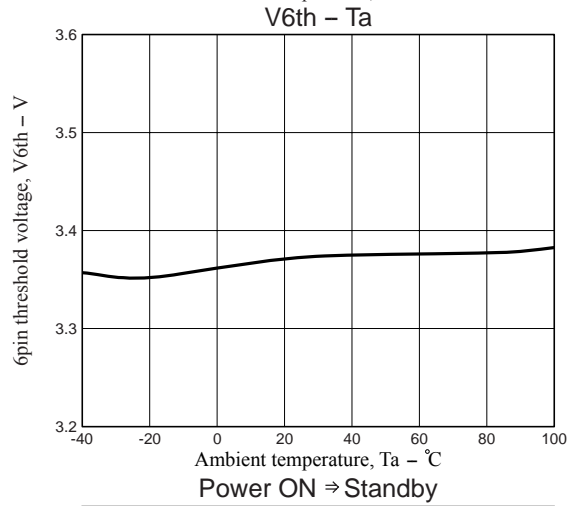
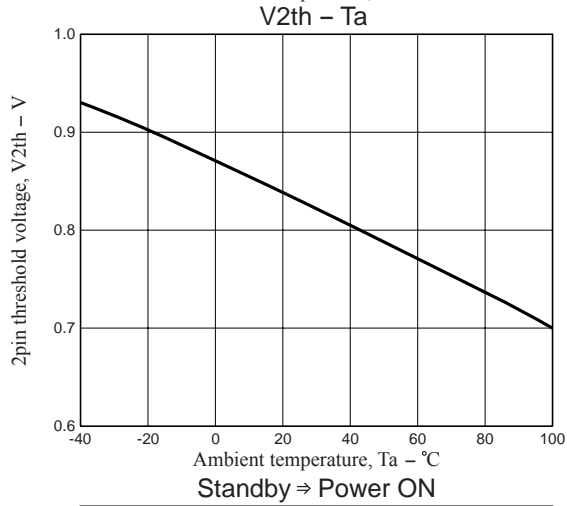
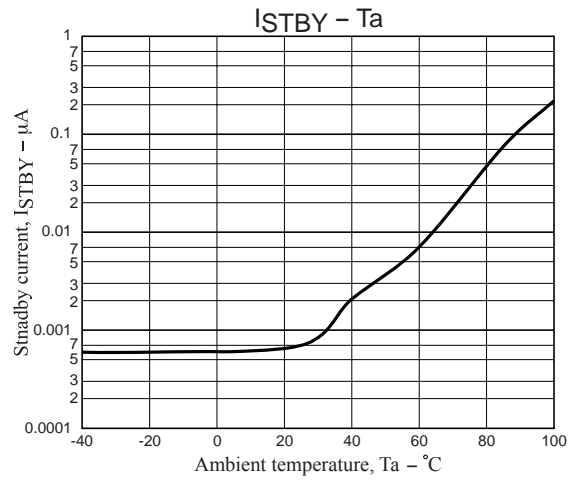
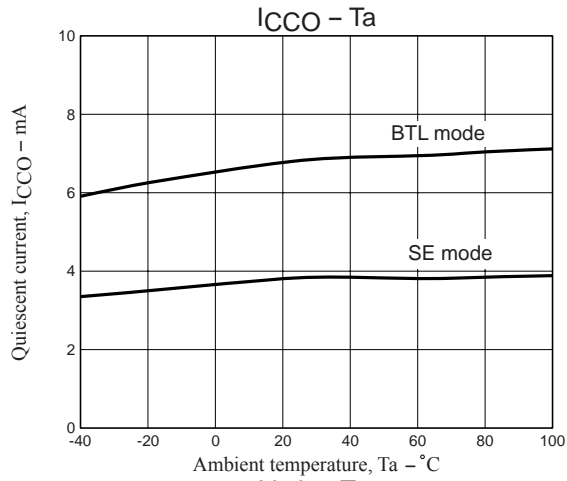

- SANYO Semiconductor Co.,Ltd. assumes no responsibility for equipment failures that result from using products at values that exceed, even momentarily, rated values (such as maximum ratings, operating condition ranges, or other parameters) listed in products specifications of any and all SANYO Semiconductor Co.,Ltd. products described or contained herein.
- SANYO Semiconductor Co.,Ltd. strives to supply high-quality high-reliability products, however, any and all semiconductor products fail or malfunction with some probability. It is possible that these probabilistic failures or malfunction could give rise to accidents or events that could endanger human lives, trouble that could give rise to smoke or fire, or accidents that could cause damage to other property. When designing equipment, adopt safety measures so that these kinds of accidents or events cannot occur. Such measures include but are not limited to protective circuits and error prevention circuits for safe design, redundant design, and structural design.
- In the event that any or all SANYO Semiconductor Co.,Ltd. products described or contained herein are controlled under any of applicable local export control laws and regulations, such products may require the export license from the authorities concerned in accordance with the above law.
- No part of this publication may be reproduced or transmitted in any form or by any means, electronic or mechanical, including photocopying and recording, or any information storage or retrieval system, or otherwise, without the prior written consent of SANYO Semiconductor Co.,Ltd.
- Any and all information described or contained herein are subject to change without notice due to product/technology improvement, etc. When designing equipment, refer to the "Delivery Specification" for the SANYO Semiconductor Co.,Ltd. product that you intend to use.
- Information (including circuit diagrams and circuit parameters) herein is for example only; it is not guaranteed for volume production.
- Upon using the technical information or products described herein, neither warranty nor license shall be granted with regard to intellectual property rights or any other rights of SANYO Semiconductor Co.,Ltd. or any third party. SANYO Semiconductor Co.,Ltd. shall not be liable for any claim or suits with regard to a third party's intellectual property rights which has resulted from the use of the technical information and products mentioned above.

This catalog provides information as of August, 2010. Specifications and information herein are subject to change without notice.