



5x7mm Surface Mount TCXO's for Cospas-Sarsat Beacons Model CSBxx Series

CONNOR WINFIELD



2111 Comprehensive Drive

Aurora, Illinois 60505

Phone: 630-851-4722

Fax: 630-851-5040

www.conwin.com

US Headquarters:

630-851-4722

European Headquarters:

+353-61-472221

Description:

The Connor-Winfield's CSBxx Series precision TCXO's are ideally suited for the next generation of emergency beacon applications. The CSBxx Series are Surface Mount, 5x7mm, 3.3V, LVCMOS or Clipped Sinewave Temperature Compensated Crystal Oscillators (TCXO) designed for emergency beacon applications requiring tight frequency stability and low power. The data is serialized and available on-line to the customer for future reference during certification. See page 4 for instructions.



Features:

- 3.3 Vdc Operation
- Frequency Stability: ± 0.20 ppm
- Mean Slope = ± 0.7 ppb/min
- Temperature Ranges Available:
Class I -40 to 55°C, Class II -20 to 55°C
Option: -10 to 65°C
- LVCMOS or Clipped Sinewave Output
- Ceramic Surface Mount Package
- Tape and Reel Packaging
- RoHS Compliant / Pb Free

Absolute Maximum Ratings

Parameter	Minimum	Nominal	Maximum	Units	Notes
Storage Temperature	-40	-	85	°C	
Supply Voltage (Vcc)	-0.5	-	6.0	Vdc	
Input Voltage	-0.5	-	Vcc+0.5	Vdc	

Operating Specifications

Parameter	Minimum	Nominal	Maximum	Units	Notes
Frequency Range: (Fo)	10	-	20	MHz	
Standard Frequencies:	10.0, 12.688375, 12.688575, 12.688656, 12.68875, 16.367, 20.0			MHz	
Frequency Stability					1
Calibration @ 25 °C	-0.50	-	0.50	ppm	2
Frequency vs. Temperature	-0.20	-	0.20	ppm	3
Frequency vs. Voltage					
$\pm 5\%$ change in Voltage	-	± 20	± 40	ppb	
$\pm 10\%$ change in Voltage	-	± 60	± 100	ppb	
Frequency vs. Load	-0.10	-	0.10	ppm	4
Allan Variance (tau = 100ms)	-1.00	-	1.00	ppb	
Mean Slope dF/dt					
Steady state conditions	-	-	± 0.7	ppb/min	1
During and 15 min after variable temp	-	-	± 1.7	ppb/min	1, 5
Residual dF from slope	-	-	± 2.0	ppb	1, 5
Reflow Soldering	-1.0	-	1.0	ppm	
Aging for 1st Year	-1.0	-	1.0	ppm	
Aging for 10 Years	-3.0	-	3.0	ppm	
Operating Temperature Range:					
Model CSB1x (Class I)	-40	-	55	°C	
Model CSB2x (Class II)	-20	-	55	°C	
Option: Model CSB3x	-10	-	65	°C	
Supply Voltage (Vcc)	2.97	3.30	3.63	Vdc	$\pm 10\%$
Supply Current (Icc)					
Model CSBx1 (LVCMOS Output)	-	2.1	-	mA	
Model CSBx2 (Clipped Sine Output)	-	1.3	-	mA	
SSB Phase Noise Fo = 10.0 MHz					
@ 1Hz offset	-	-68	-	dBc/Hz	
@ 10Hz offset	-	-100	-	dBc/Hz	
@ 100Hz offset	-	-129	-	dBc/Hz	
@ 1KHz offset	-	-148	-	dBc/Hz	
@ 10KHz offset	-	-154	-	dBc/Hz	
@ 100KHz offset	-	-154	-	dBc/Hz	
@ 1MHz offset	-	-154	-	dBc/Hz	
Start-up Time	-	-	10	ms	

Models CSB11 and CSB21 LVCMOS Output Characteristics

Parameter	Minimum	Nominal	Maximum	Units	Notes
Load	-	15	-	pF	6
Voltage (High) (Voh)	90%Vcc	-	-	Vdc	
(Low) (Vol)	-	-	10%Vcc	Vdc	
Current (High) (Ioh)	-4	-	-	mA	
(Low) (Iol)	-	-	4	mA	
Duty Cycle at 50% of Vcc	45	50	55	%	
Rise / Fall Time 10% to 90%	-	-	8	ns	

Models CSB12 and CSB22 Clipped Sinewave Output Characteristics

Parameter	Minimum	Nominal	Maximum	Units	Notes
Output Load Resistance	-	10K	-	Ohm	6
Output Load Capacitance	-	10	-	pF	6
Output Voltage	1.0	-	-	V pk-pk	AC Coupled

Ordering Information

CSB	1	1	- 010.0M
Package Type	Temperature Range	Output Type	Output Frequency
5x7 mm Package	1 = -40 to 55°C (Class I) 2 = -20 to 55°C (Class II) 3 = -10 to 65°C	1 = LVCMOS 2 = Clipped Sinewave	Frequency Format * -xxx.xM Min., -xxx.xxxxxM Max.* Amount of numbers after the decimal point. M = MHz
C/S Beacon			

Example Part Number: CSB11-010.0M



Tri-State Enable / Disable Input Characteristics

Parameter	Minimum	Nominal	Maximum	Units	Notes
Enable Voltage (High)	70%Vcc	-		Vdc	7
Disable Voltage (Low)	-	-	30%Vcc	Vdc	

Environmental Characteristics

Vibration:	Vibration per Mil Std 883E Method 2007.3 Test Condition A
Shock:	Mechanical Shock per Mil Std 883E Method 2002.4 Test Condition B.
Soldering Process:	RoHS compliant lead free. See soldering profile on page 4.

Package Characteristics

Package	Hermetically sealed ceramic package and grounded metal cover. RoHS compliant, lead free.
---------	------------------------------------------------------------------------------------------

Notes:

1. Medium term stability (Specified and measured according to the latest release of "Specification for Cospas-Sarat-406 MHz distress Beacon" C/S T.001. Averaged over 18 measurements in 15 minute period and following 15 minute warm up.)
2. Frequency referenced to Fo.
3. Frequency stability vs. change in temperature. $[\pm(F_{max} - F_{min})/(2 \cdot F_o)]$.
4. Referenced to 15 pF, $\pm 5\%$.
5. $dT/dt \leq \pm 5^\circ\text{C}/\text{hour}$
6. Attention: To achieve optimal frequency stability, and in some cases to meet the specification stated on this data sheet, it is required that the circuit connected to this TCXO output must have the equivalent input capacitance that is specified by the nominal load capacitance. Deviations from the nominal load capacitance will have a graduated effect on the stability of approximately 20 ppb per pF load difference.
7. Oscillator and compensation circuit are still active when output is disabled during tri-state mode. Output is enabled with no connection on pad 8. Supply current is $\sim 1\text{mA}$ when output is disabled.

Package Layout

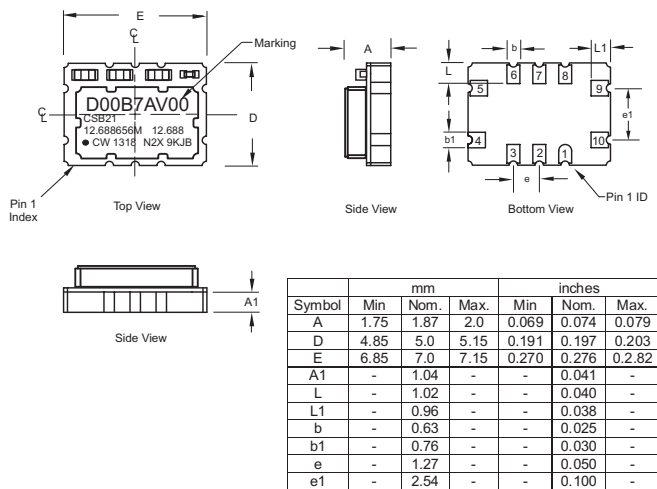

Suggested Pad Layout

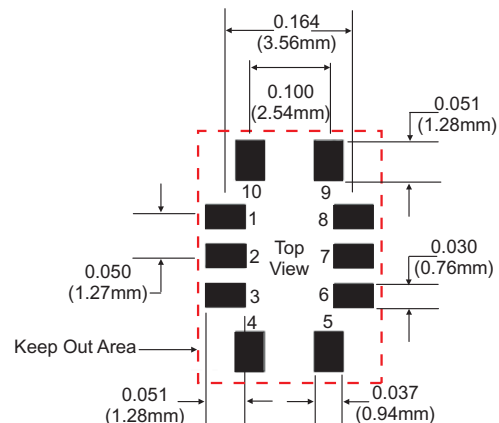

Keep Out Area: Do not route any traces in the keep out area. It is recommended the next layer under the keep out area is to be ground plane.

Marking Information

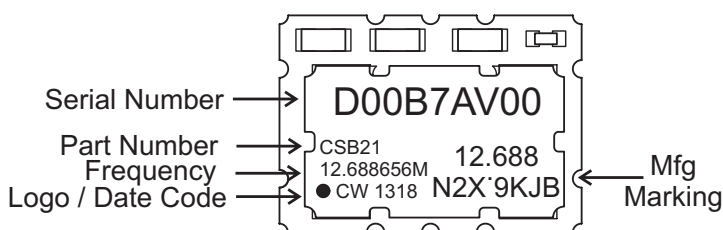

Pad Connections

- 1: Do Not Connect
- 2: Do Not Connect
- 3: Do Not Connect
- 4: Ground
- 5: Output
- 6: Do Not Connect
- 7: Do Not Connect
- 8: Enable /Disable (OE)
- 9: Supply Voltage (Vcc)
- 10: N/C

Conformance Data

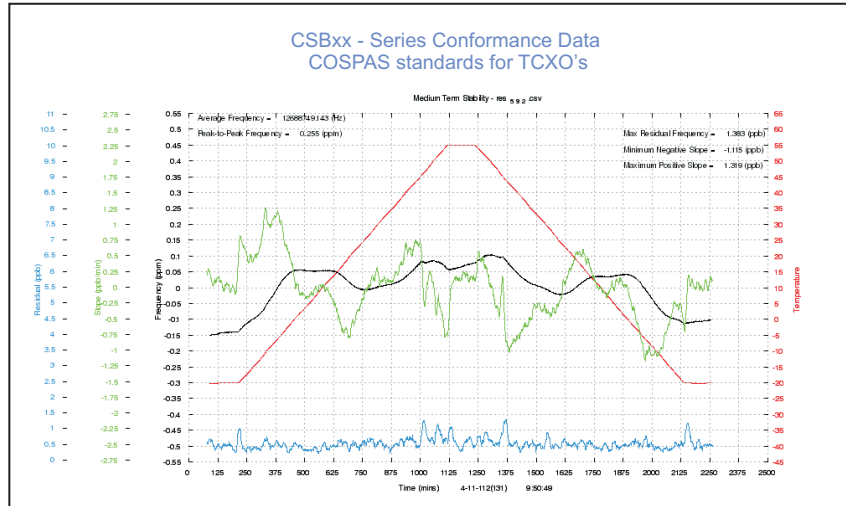

Phase Noise Plot

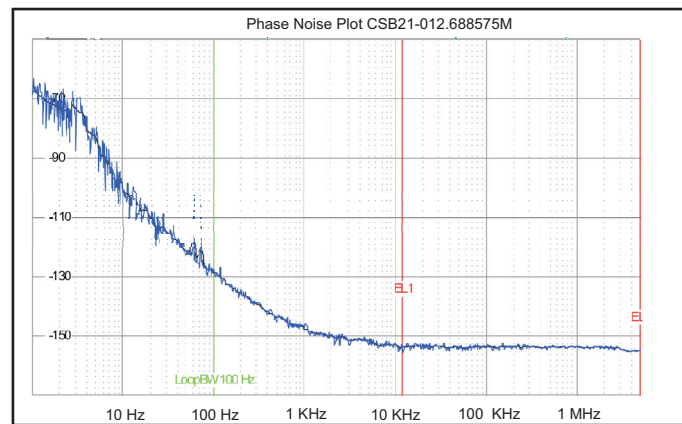

Supply Coefficient Graph

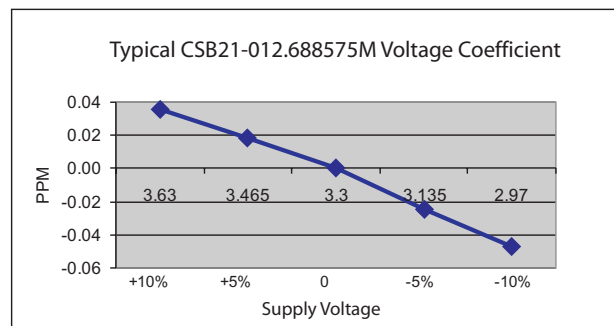

Clipped Sinewave Test Circuit

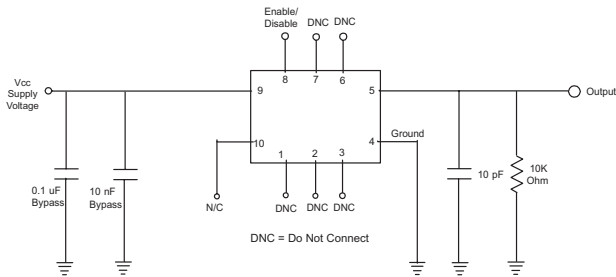

CMOS Test Circuit

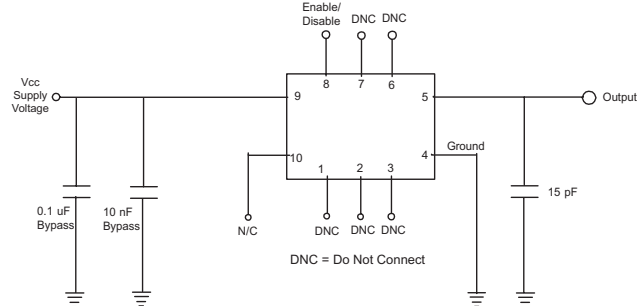

Output Waveform

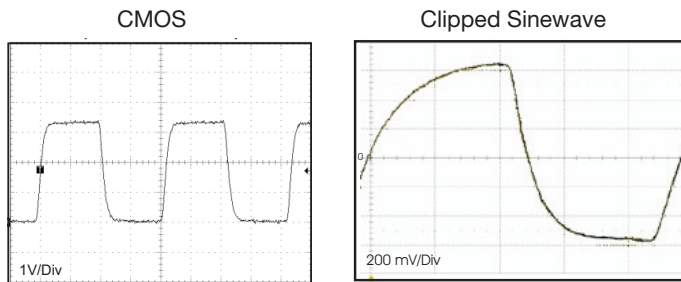

Solder Profile

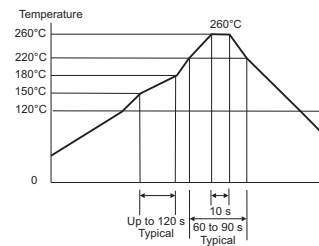

Meets IPC/JEDEC J-STD-020C

Tape and Reel Dimensions

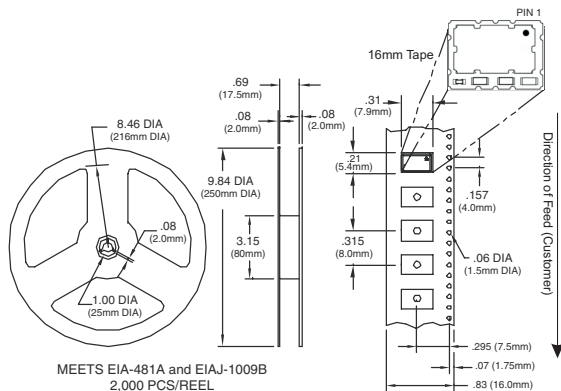

Design Recommendations

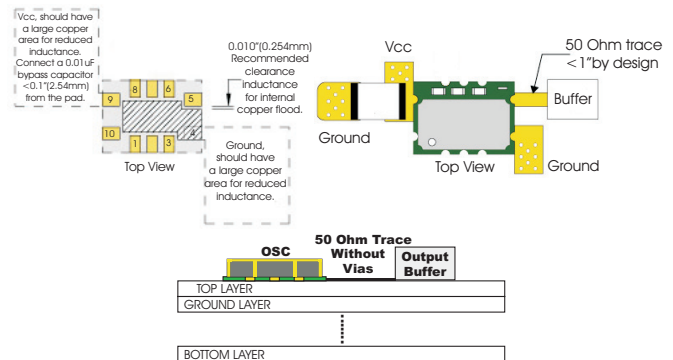

Test Data Availability

Serialized test data files are available on-line for all CSB-Series parts.
Please contact Connor-Winfield's Sales Department for more information.
Call: 630-851-4722 or Email: sales@conwin.com

Revision History

Revision	Date	Note
00	01/03/10	Data sheet release.
01	01/28/11	Added 12.68875 MHz to the data sheet.
02	07/31/12	Added conformance data
03	04/30/13	Updated marking, added serial number.
04	10/22/13	Added IPC package drawing, footprint and test data availability.
05	10/29/13	Updated Voltage coefficient.
06	10/20/15	Added -10 to +65C temperature range option.
07	02/21/17	Corrected dimension error in Suggested Pad Layout.

Bulletin	TX301
Page	4 of 4
Revision	07
Date	21 Feb 2017