

FT825-12S480mA Design Report

Title	18 Watts Isolated PSR LED Driver with High PF
Specification	Input Voltage: 90~264Vac; 50/60Hz Output Voltage: 40V_dc Output Current: 480mA_dc
Application	Power Driver for LED T8 Tube
Author	FMD Application Engineering Department
Date	2012-10-22
Reversion	2.0

FEATURES

- Ultra-thin (less than 10mm) design;
 - The LED driver can be assembled at the back side of LED Display Boards, to get well-distributed LED light.
- Highly energy efficient
 - >87%@115Vac input; >88%@230Vac input
- High PF value
 - >0.93, 90~264Vac input
- Minimum BOM, PCB Size minimized, highly cost-competitive
 - Length of Printed Circuit Board is 216mm
- Integrated protection and reliability features
 - LED Open / Short-circuited Protection with auto recovery
 - Cycle by Cycle Current Limiting Protection
- No over-shoot for LED output current during start-up, high reliability and long lifetime.
- ON/OFF test passed (Input 264Vac, 4S ON/ 4S OFF, endured 10000 times)
- Meets IEC 61000-4-5 Surge, IEC 61000-3-2 Class C harmonics requirements
- Meet EMI EN55015 B & FCC Part 18 Class B standard

Contents

1	Brief Introduction.....	3
2	Power Supply Specification.....	4
3	Circuit Diagram.....	5
4	PCB Layout	6
5	Bill of Materials.....	7-8
6	Transformer Specification.....	9
7	Performance Test Data.....	10
7.1	Input Voltage vs Output Current/ Power Factor/ THD/ Efficiency.....	10-12
7.2	Output Voltage vs Output Current	13
7.3	Temperature Rise.....	14
8	Key Waveforms	15
8.1	Line Voltage and Current.....	15
8.2	Power MOSFET Vds(p-p) and Ids(p-p) Under Working.....	15
8.3	Power MOSFET Vds(p-p) and Ids(p-p) At Start-up.....	15
8.4	Power MOSFET Vds(p-p) and Ids(p-p) While Output is Short-circuited.....	16
8.5	Output Voltage and Current with Full-load.....	16
8.6	Output Voltage and Current While Output is Short-circuited.....	16
8.7	Output Voltage with No-Load (LED Open).....	17
8.8	Output Voltage and Current At Start-up.....	17
9	EMI.....	18
9.1	Conducted EMI Measurement.....	18-21
9.2	Radiated EMI measurement.....	22-25

1 Brief Introduction

The FT825-12S480mA LED driver is an isolated PSR solution, utilizing Fly back topology that works in Boundary Conduction Mode (BCM) with Power Factor Correction (PFC) function. It works under universal AC voltage from 90V to 264V and provides output voltage 25~44Vdc & output current 0.48A for LED strings.

Few components are used in the FT825-12S480mA LED driver; it increases the power density and reduces the total material cost, in contrast to conventional single stage PFC solution with opto-coupler and secondary CC/CV circuit. Meanwhile, the PSR controller IC FT825 is combined with optimized system design, which guarantees the LED driver system working in BCM to enhance efficiency for the LED driver.

The design target is to keep the LED driver ultra-thin and highly energy efficient. It facilitates the assembly of the end products LED T8 Tubes while keeping the temperature rise of all components within an acceptable range.



Figure 1. PCB Assembly (Top View)



Figure 2. PCBA Assembly (Bottom View)



Figure 3. PCBA Height (<10mm)

2 Power Supply Specification

The table below represents the minimum acceptable performance of the design.
Actual performance is listed in the results section.

Description	Symbol	Min.	Typical	Max.	Unit	Remark
Input Voltage Frequency	V _{in} f _{LINE}	90 47	115/230 50/60	264 64	Vac Hz	2 Wires, no P.E. Class II Equipment
Output Output Voltage Output Current Continuous Output Power	V _{out} I _{out} P _{out}	25	40 0.48 19.2	42	V A W	
Efficiency Full Load	η	87			%	Measured at 115/230Vac input
Environmental Conducted EMI Radiated EMI Safety		Meet CISPR 15B/EN55015B FCC Part 15 Class B / EN55015 Meet IEC60950				
Power Factor		0.93				Measured at 12S 480mA rating and 90~264Vac input
Total Harmonic Distortion	THD			20	%	Measured at 12S 480mA rating and 90~264Vac input
PCBA Dimension		216X17.5X10			mm	
Ambient Temperature	T _{AMB}		60		°C	Natural Ventilation Sea Level

3 Circuit Diagram

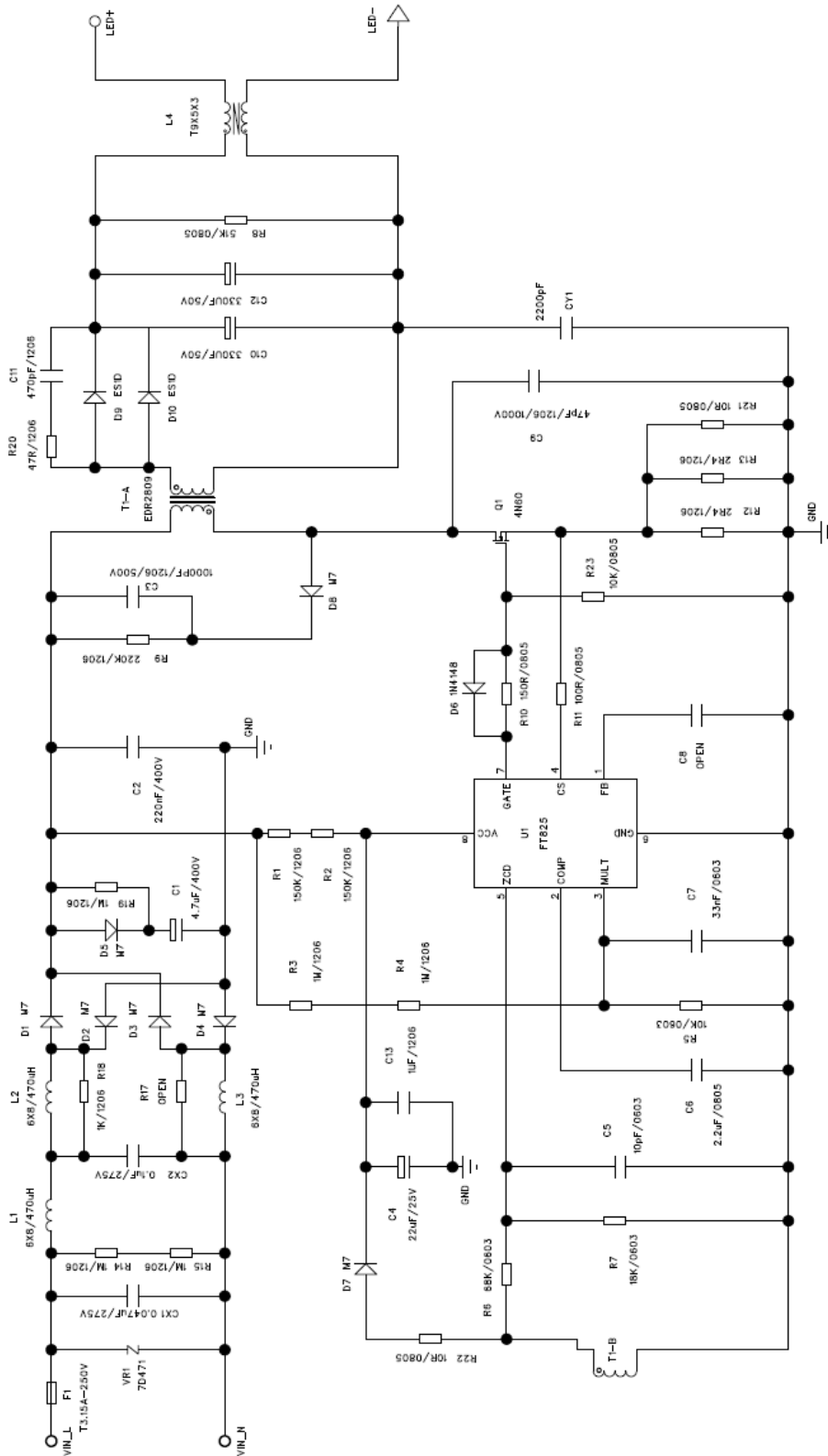

Figure 4. Circuit Diagram

4 PCB Layout

- Double-sided PCB, Material FR-4; copper foil 10Z
- SMD and discrete components are assembled on the same Layer (Top View)

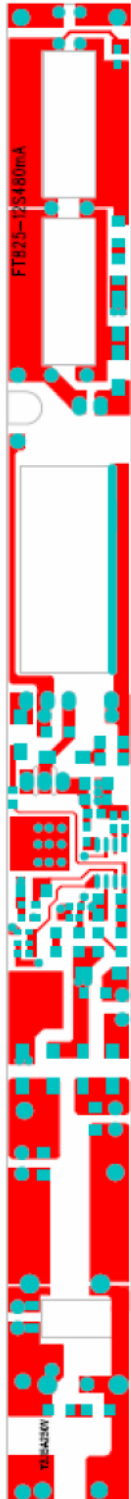

Figure 5. PCB Layout (Top View)

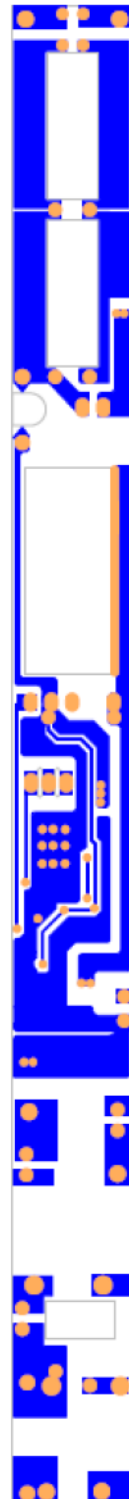
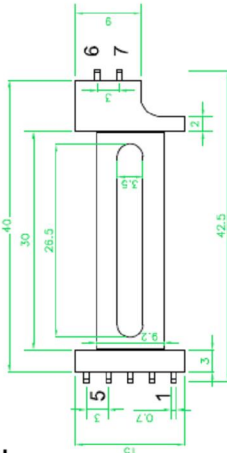

Figure 6. PCB Layout (Bottom View)

6 Transformer Specification

1. Dimension of Bobbin:

Bottom View:
Unit: mm



2. Manufacturing Requirement:

- a. All windings shall be wound as per right Inner Windings Diagram.
- b. Transformer finish-goods shall be vacuumed before dipping varnish.
- c. Bobbin: EDR2809-7PIN. Ferrite Core: EDR2809, Material PC40 or equivalent ;
- d. Air gap is obtained by smashing center leg of cores.
- e. Pin 4 length shall be kept less than 1.2 mm after transformer finish-goods assembly.
- f. Having core connect to Pin 5 via one copper wire, then wrapped around the transformer with polymer tape.
- g. All units are mm.

3. Winding Diagram

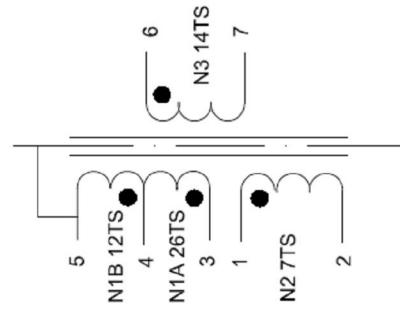

4. Electrical Specification:

- 1) L(N1 3P-5P)=670uH ± 7%(1KHz, 1V, SER)
- 2) HI-POT: N1 N2/N3:3.6KVAC 5mA 3Sec;
- 3) Leakage Inductance (5-3) : LN1<50uH (1KHz, 1V, SER), other windings shall be short(N2,N3)

5. Inner Windings Diagram

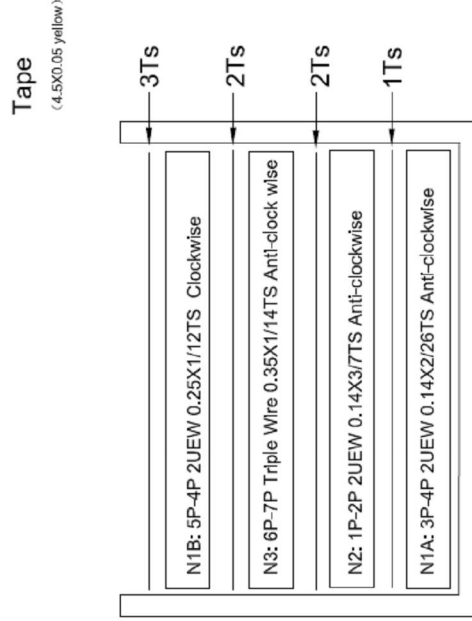

TITLE: EDR2809-7Pin	DRAWING	Xiangbin.shu	DATE: Dec-24, 2012
MODEL NO.: FT825-12S480mA-T1	CHECKED		DATE:
	APPROVED		DATE:

7 Performance Test Data

All measurement data are obtained under ambient temperature.

7.1 Input Voltage/ Output Current/ PF/ THD/ Efficiency

Vin (Vac)	Vout (V)	Vripple (V)	Iout (mA)	Iripple (mA)	PFC	THD(%)	Iin(mA)	Pin(W)	Eff.(%)
90	40	2.40	483	210	0.988	11.84	255.0	22.560	85.64
110	40	2.36	484	212	0.988	12.99	204.7	22.191	87.24
130	40	2.36	485	208	0.987	13.73	171.7	21.997	88.19
150	40	2.32	485	208	0.987	14.15	147.9	21.895	88.60
170	40	2.32	485	206	0.986	14.78	130.3	21.840	88.83
190	40	2.32	485	204	0.983	15.59	116.9	21.841	88.82
210	40	2.32	484	202	0.978	16.24	106.7	21.876	88.50
230	40	2.32	485	204	0.971	16.85	98.5	21.955	88.36
250	40	2.32	485	202	0.960	17.35	92.0	22.075	87.88
264	40	2.28	486	200	0.953	17.70	88.4	22.179	87.65

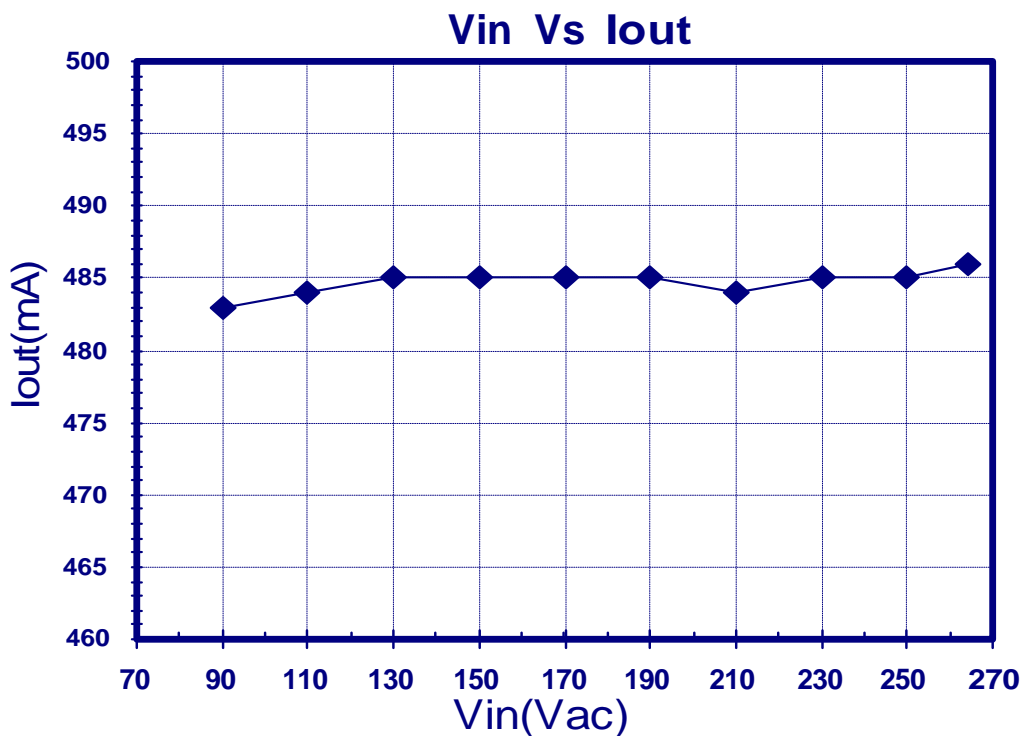

Figure 7. I_o vs V_{in}(ac) @ T_a=25°C

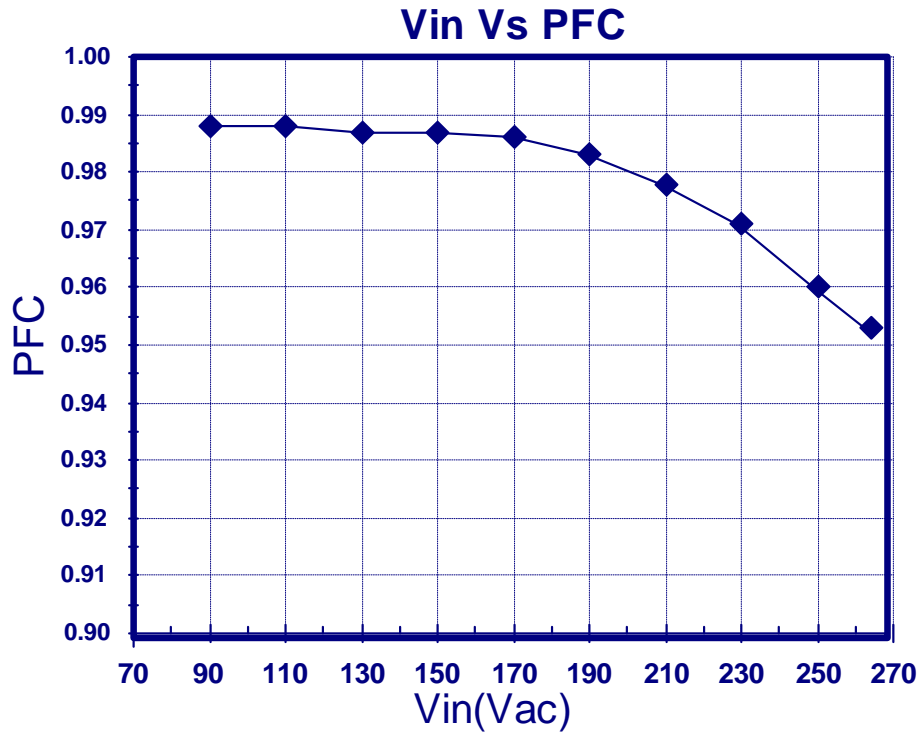

Figure 8. PF vs Vin(ac) @ Ta=25°C

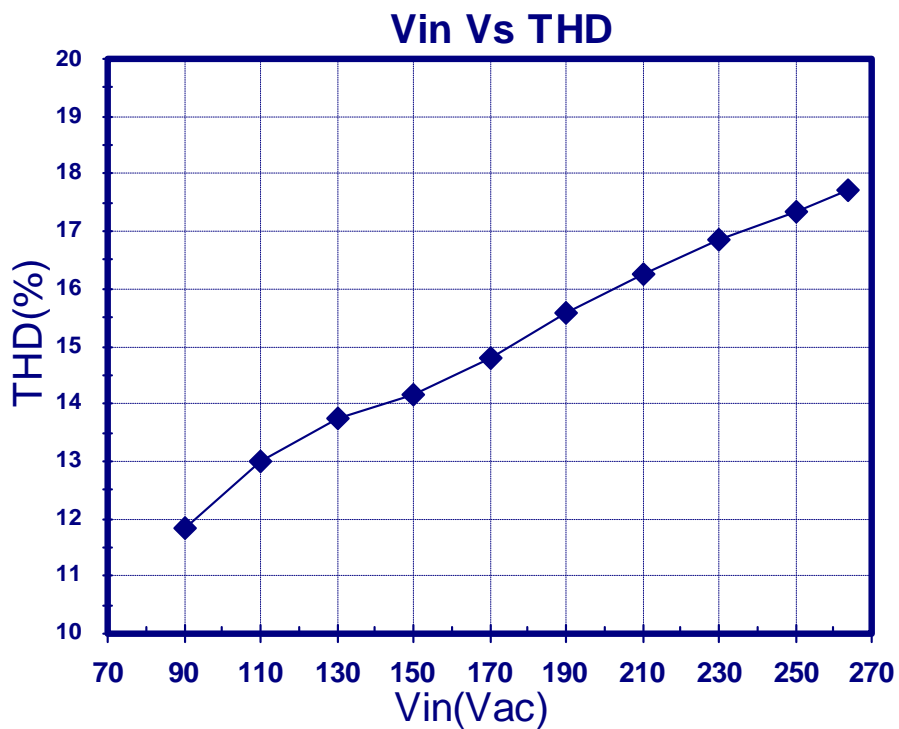

Figure 9. THD vs Vin(ac) @ Ta=25°C

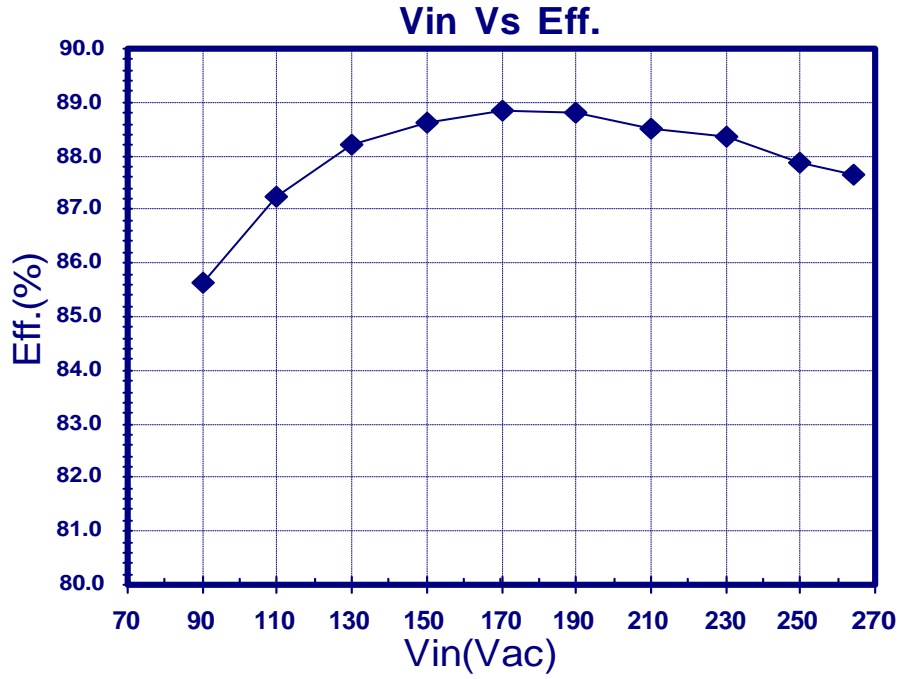

Figure 10. Efficiency vs Vin(ac) @ Ta=25°C

7.2 Output Voltage and Output Current

Vin=90Vac		Vin=264Vac	
Vout(V)	Iout(mA)	Vout(V)	Iout(mA)
50.2	0	50.3	0
46.0	481	46.0	483
45.0	481	45.0	483
42.0	482	42.0	485
40.0	483	40.0	486
35.0	484	35.0	491
30.0	487	30.0	495
25.0	491	25.0	500
20.0	494	20.0	504
19.5	495	19.5	504

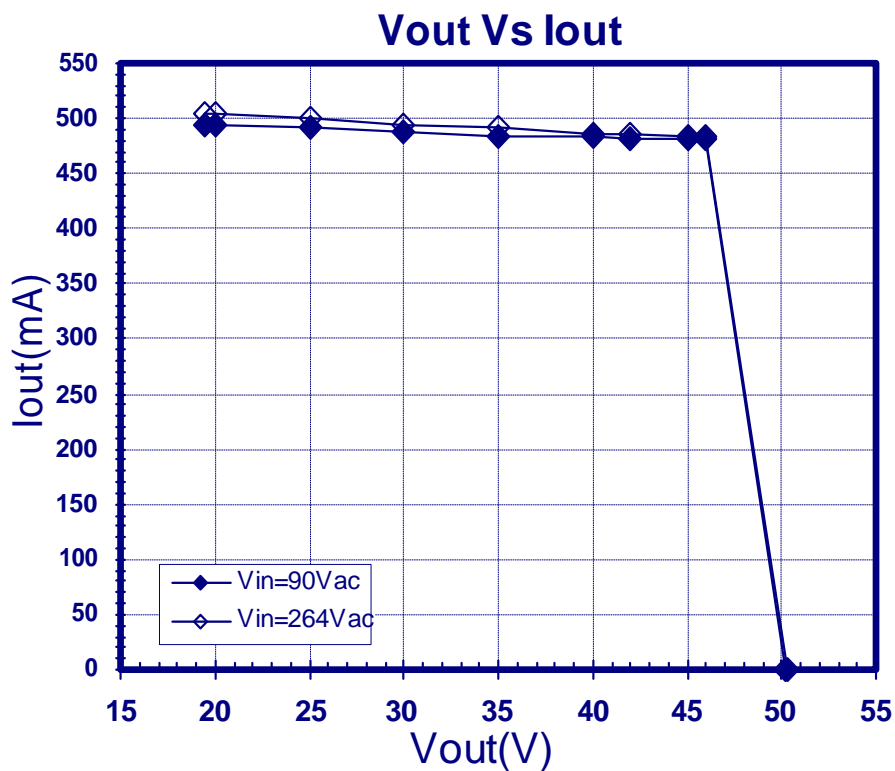

Figure 11. Iout vs Vout @ Ta=25°C

7.3 Temperature Rise

It is measured after EUT running 30minutes and under room temperature.

Test Conditions:

Vin=90Vac, Full-load

Vin=115Vac, Full-load

Vin=230Vac, Full-load

Vin=264Vac, Full-load

Part	Temperature (°C)				Temperature Rise (°C)			
	90Vac	115Vac	230Vac	264Vac	90Vac	115Vac	230Vac	264Vac
U1	50.6	48.0	47.6	49.8	21.8	19.4	18.8	21.3
Q1	63.5	55.9	52.0	55.1	34.7	27.3	23.2	26.6
T1-W	49.3	48.3	46.6	47.4	20.5	19.7	17.8	18.9
T1-C	55.9	53.5	51.7	52.9	27.1	24.9	22.9	24.4
D9	52.3	52.5	55.5	56.6	23.5	23.9	26.7	28.1
D10	63.1	62.9	65.6	67.0	34.3	34.3	36.8	38.5
C10	39.9	40.4	42.1	42.9	11.1	11.8	13.3	14.4
C12	35.1	35.2	37.0	37.7	6.3	6.6	8.2	9.2
D7	61.8	58.0	55.5	58.0	33.0	29.4	26.7	29.5
D8	54.2	50.4	48.3	49.9	25.4	21.8	19.5	21.4
Ta	28.8	28.6	28.8	28.5	-	-	-	-

8 Key Waveforms

8.1 Line Voltage and Current

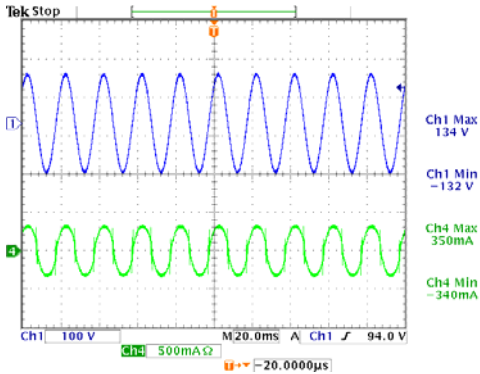

Figure 12. 90Vac, Full load
Channel 1: Vin, 100V/Div
Channel 4: Iin, 500mA/Div

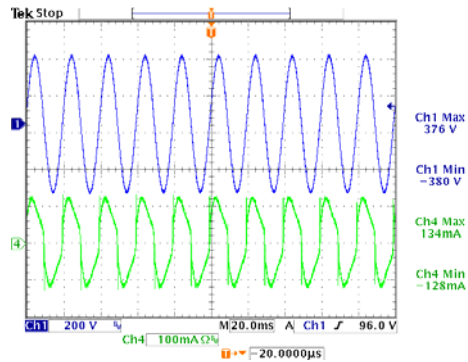

Figure 13. 264Vac, Full load
Channel 1: Vin, 100V/Div
Channel 4: Iin, 500mA/Div

8.2 Power MOSFET Vds(p-p) and Ids(p-p)

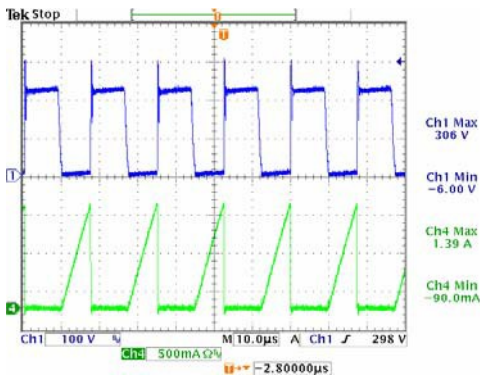

Figure 14. 90Vac, Full load
Channel 1: Vds, 100V/Div
Channel 4: Id, 500mA/Div

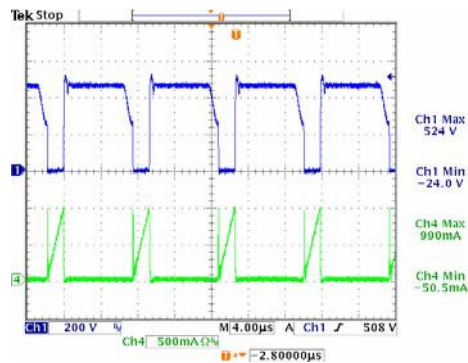

Figure 15. 264Vac, Full load
Channel 1: Vds, 200V/Div
Channel 4: Id, 500mA/Div

8.3 Power MOSFET Vds(p-p) and Ids(p-p) At Start-up

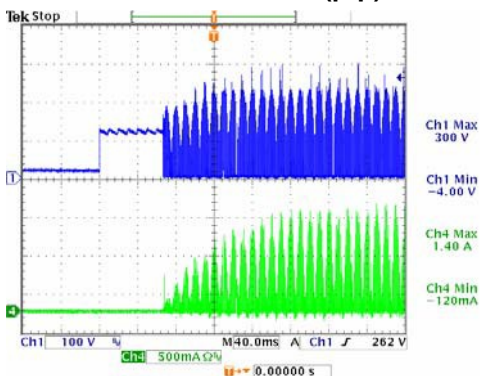

Figure 16. 90Vac, Full load
Channel 1: Vds, 100V/Div
Channel 4: Id, 500mA/Div

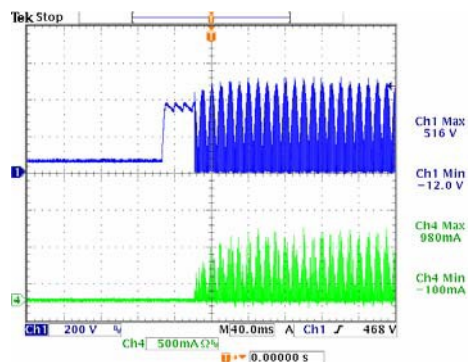

Figure 17. 264Vac, Full load
Channel 1: Vds, 200V/Div
Channel 4: Id, 500mA/Div

8.4 Power MOSFET Vds(p-p) and Ids(p-p) While Output is Short-circuited

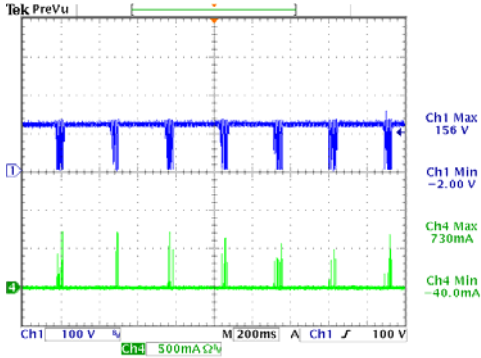

Figure 18. 90Vac, Full load
Channel 1: Vds, 100V/Div
Channel 4: Id, 500mA/Div

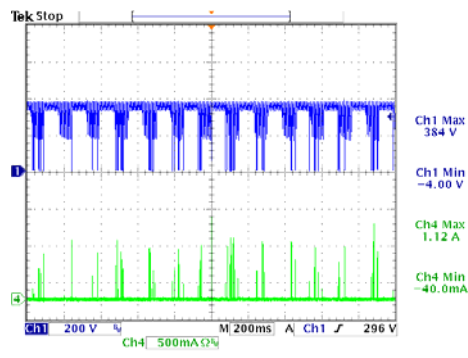

Figure 19. 264Vac, Full load
Channel 1: Vds, 200V/Div
Channel 4: Id, 500mA/Div

8.5 Output Voltage and Current with Full-load

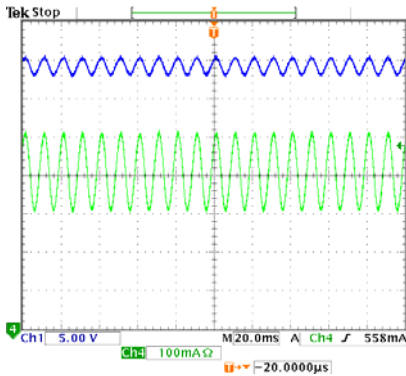

Figure 20. 90Vac, Full load
Channel 1: Vout, 5V/Div
Channel 4: Iout, 100mA/Div

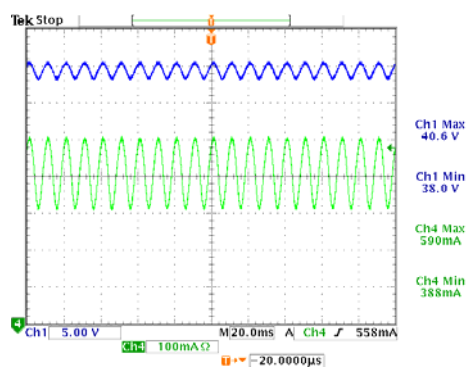

Figure 21. 264Vac, Full load
Channel 1: Vout, 5V/Div
Channel 4: Iout, 100mA/Div

8.6 Output Voltage and Current While Output is Short-circuited

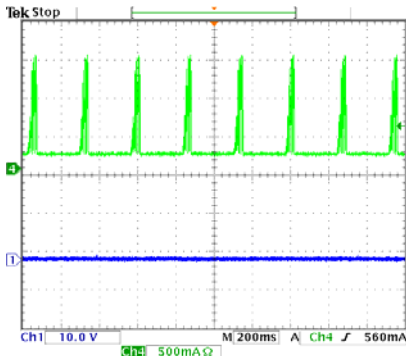

Figure 22. 90Vac, Full load
Channel 1: Vout, 10V/Div
Channel 4: Iout, 500mA/Div

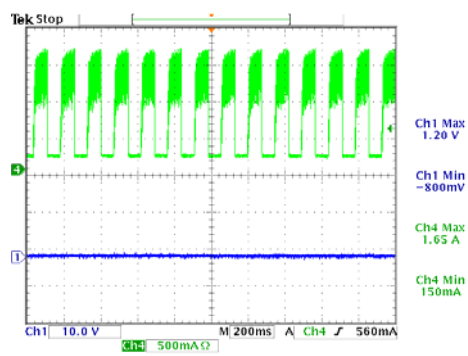

Figure 23. 264Vac, Full load
Channel 1: Vout, 10V/Div
Channel 4: Iout, 500mA/Div

8.7 Output Voltage and Current with No-load (LED Open)

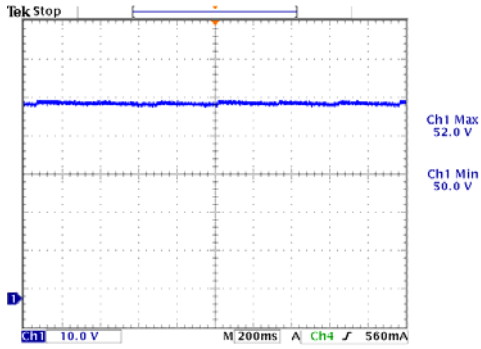

Figure 24. 90Vac, No load
Channel 1: Vout, 10V/Div

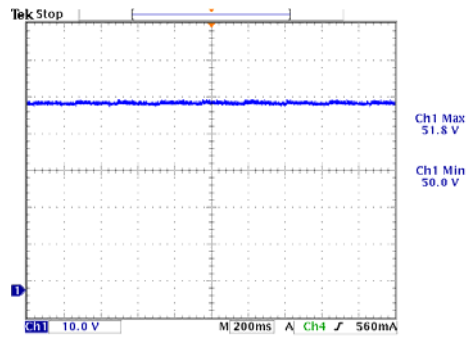

Figure 25. 264Vac, No load
Channel 1: Vout, 10V/格

8.8 Output Voltage and Current At Start-up

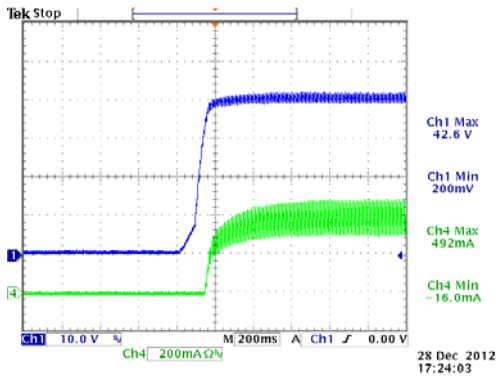

Figure 26. 90Vac, Full load
Channel 1: Vout, 10V/Div
Channel 4: Iout, 200mA/Div

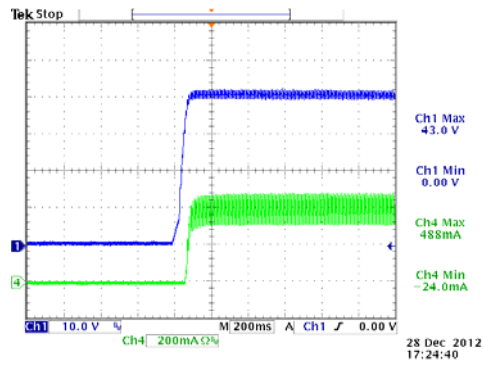

Figure 27. 264Vac, Full load
Channel 1: Vout, 10V/Div
Channel 4: Iout, 200mA/Div

Fremont Micro Devices (SZ) Limited

#5-8, 10/F, Changhong Building, Ke-Ji Nan 12 Road, Nanshan District, Shenzhen

Tel: (86 755) 86117811

Fax: (86 755) 86117810

Fremont Micro Devices (Hong Kong) Limited

#16, 16/F, Blk B, Veristrong Industrial Centre, 34-36 Au Pui Wan Street, Fotan, Shatin, Hong Kong

Tel: (852) 27811186

Fax: (852) 27811144

Fremont Micro Devices (USA), Inc.

42982 Osgood Road Fremont, CA 94539

Tel: (1-510) 668-1321

Fax: (1-510) 226-9918

Web Site: <http://www.fremontmicro.com/>

* Information furnished is believed to be accurate and reliable. However, Fremont Micro Devices, Incorporated (BVI) assumes no responsibility for the consequences of use of such information or for any infringement of patents of other rights of third parties which may result from its use. No license is granted by implication or otherwise under any patent rights of Fremont Micro Devices, Incorporated (BVI). Specifications mentioned in this publication are subject to change without notice. This publication supersedes and replaces all information previously supplied. Fremont Micro Devices, Incorporated (BVI) products are not authorized for use as critical components in life support devices or systems without express written approval of Fremont Micro Devices, Incorporated (BVI). The FMD logo is a registered trademark of Fremont Micro Devices, Incorporated (BVI). All other names are the property of their respective owners.