

OMRON

Enabling Grip Switch

A4EG

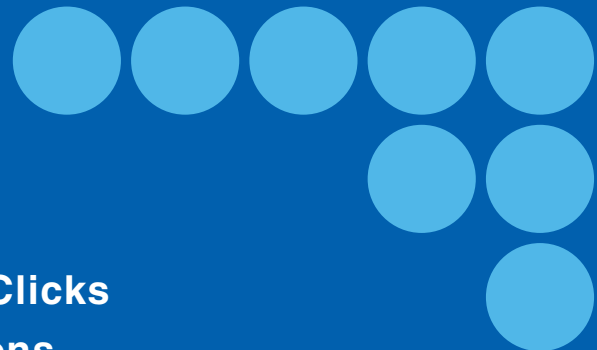

Enabling Grip Switch with Distinct Clicks
for Three Easily Discernable Positions



realizing

A4EG-C000041 A4EG-BE2R041 A4EG-BM2B041
Equipped with an Equipped with a
Emergency Stop Switch Momentary Operation Switch

Helps Ensure Safety during Maintenance

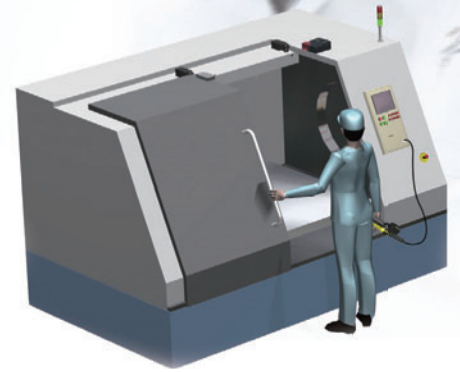

Enabling grip switches are safety components used to prevent unexpected machine operation when workers perform maintenance or other non-routine tasks inside hazardous areas, such as areas inside protective shields.

For more information, refer to the Safety Components Series Catalog (Cat. No. Y106).

Positive Operating Feel

Original Double Snap Action switch mechanism lets the operator precisely confirm the enable position.

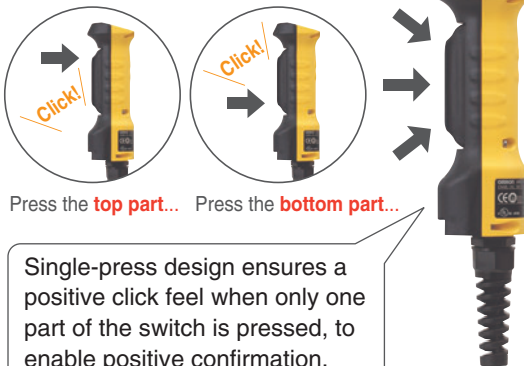

Press the **top part**... Press the **bottom part**...

Single-press design ensures a positive click feel when only one part of the switch is pressed, to enable positive confirmation.

Safety Circuits Are Easy to Configure

Safety circuits can be easily configured by combining the A4EG with the G9SX-GS Safety Guard Switching Unit.

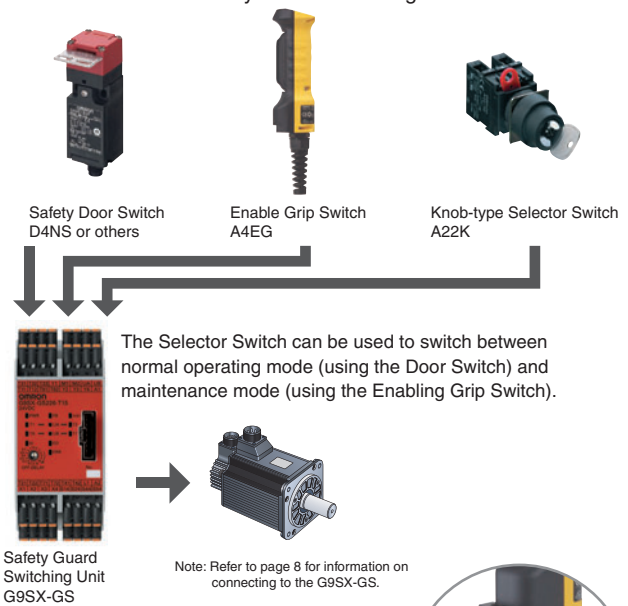

Selection Based on Application

In addition to the standard models, the lineup also includes models with an emergency stop switch and models with a momentary operation switch.



Wall-mounted with Bracket



A4EG-C000041



A4EG-BE2R041
Equipped with an
Emergency Stop Switch



A4EG-BM2B041
Equipped with a
Momentary Operation Switch

A holding key can be used to change modes rather than a key-type selector switch.



Normal operating mode



Maintenance mode

Safety Door Switch
D4NS

Enabling Grip Switch A4EG

Enabling Grip Switch with Distinct Feel for Three Easily Discernible Positions



- The difficult task of configuring safety circuits is now easily achieved by combining the A4EG with the G9SX-GS.
- In addition to the standard models, the lineup also includes models with an emergency stop switch and models with a momentary operation switch.
- An optional Holding Key (sold separately) provides a versatile method for selecting modes.
- Equipped with conduit connector.





 Be sure to read the "Safety Precautions" on page 12.

Ordering Information

Enabling Grip Switches

| Appearance | Contact form | | | Model |
|---|-----------------|----------------------|-------------------------------------|---------------------|
| | Enabling switch | Monitor switch | Pushbutton switch | |
|  | Two contacts | 1NC (grip output) | None | A4EG-C000041 |
|  | Two contacts | None | Emergency stop switch (2NC) | A4EG-BE2R041 |
|  | Two contacts | None | Momentary operation switch (2NO) | A4EG-BM2B041 |

Accessories (Order Separately)

| Appearance | Item | Model |
|---|--|-----------------|
|  | Rubber Cover (replacement part) | A4EG-OP1 |
|  | Mounting Bracket (for securing the A4EG) | A4EG-OP2 |
|  | Holding Key | A4EG-OP3 |

A4EG

Specifications

Standards and EC Directives

Compliance with EC Directives and International Standards

- Low Voltage Directive
- GS-ET-22

Certified Standards

| Certifying body | Standard | File No. |
|-----------------|--|--------------------------------|
| TÜV SÜD | EN 60947-5-1 (certified direct opening) | Ask your OMRON representative. |
| UL * | UL 508, CSA C22.2 No.14 | E76675 |
| CQC (CCC) | GB 14048.5 | 2008010305297698 |
| KOSHA | EN60947-5-1 | 2008-115 |

* Certification for CSA C22.2 No. 14 by UL is indicated by the .

Certified Standard Ratings (Enabling Switch Section)

TÜV (EN 60947-5-1)

| Item | Utilization category | AC-15 | DC-13 |
|------------------------------|----------------------|--------|--------|
| Rated operating current (Ie) | | 0.75 A | 0.55 A |
| Rated operating voltage (Ue) | | 240 V | 125 V |

Note: Use a 10-A fuse type gI or gG that conforms to IEC 60269 as the short-circuit protection device. The fuse is not built into the Switch.

UL/CSA (UL 508, CSA C22.2 No.14), CCC (GB 14048.5)

- 24 VDC, 0.3 A (inductive load)
- 125 VAC, 1 A (resistive load)

Ratings

| Item | Section | Enabling switch | Emergency stop switch (A4EG-BE2R041 only) | Pushbutton (A4EG-BM2B041 only) |
|--------------------------|---------|---|---|---|
| Rated insulation voltage | | 250 V | | --- |
| Rated ON current | | 2.5 A | 5 A | 0.1 A |
| Rated load | | 24 VDC, 0.3 A (inductive load) 125 VAC, 1 A (resistive load) EN certification rating: AC-15 0.75 A/240 V DC-13 0.55 A/125 V | General rating: 125 VAC, 5 A (resistive load) 250 VAC, 3 A (resistive load) 30 VDC, 3 A (resistive load) UL and cUL rating: 125 VAC, 5A (inductive load, power factor: 0.75 to 0.8) 250 VAC, 3 A (inductive load, power factor: 0.75 to 0.8) 30 VDC, 3 A (resistive load) EN certification rating: AC-12 3 A/250 V DC-12 3 A/30 V | General rating: 125 VAC, 0.1 A (resistive load) 8 VDC, 0.1 A (resistive load) 14 VDC, 0.1 A (resistive load) 30 VDC, 0.1 A (resistive load) UL and cUL rating: 125 VAC, 0.1 A (resistive load) 30 VDC, 0.1 A (resistive load) EN certification rating: AC-12 0.1 A/125 V DC-12 0.1 A/30 V |
| Minimum applicable load | | 24 VDC, 4 mA | | 5 VDC, 1 mA |

Characteristics

| Item | Section | Enabling switch | Emergency stop switch (A4EG-BE2R041 only) | Pushbutton (A4EG-BM2B041 only) |
|---|--|--|--|--------------------------------------|
| Degree of protection | | IP66 (A4EG-C000041), IP65 (A4EG-BE2R041, A4EG-BM2B041) | | |
| Operating section strength | | Operating direction: 200 N, 1 min | Operating direction: 367 N, 1 min Rotating direction: 0.49 N·m, 1 min | Operating direction: 50 N, 1 min |
| Cable pull strength | | 30 N, 1 min | | |
| Allowable operating frequency | Electrical | 20 operations/minute max. | 10 operations/minute max. (set/reset for one operation) | 60 operations/minute max. |
| | Mechanical | 20 operations/minute max. | 10 operations/minute max. (set/reset for one operation) | 120 operations/minute max. |
| Electrical durability | | 100,000 operations min. (rated load) | 100,000 operations min. (set/reset for one operation) (rated load) | 100,000 operations min. (rated load) |
| Mechanical durability | | OFF-ON-OFF (direct opening): 100,000 operations min. OFF-ON: 1,000,000 operations min. | 100,000 operations min. (set/reset for one operation) | 2,000,000 operations min. |
| Dielectric strength | Between terminals of the same polarity | 2,500 VAC, 50/60 Hz, 1 minute (impulse voltage) | 1,000 VAC, 50/60 Hz, 1 minute | 1,000 VAC, 50/60 Hz, 1 minute |
| | Between terminals of the different polarity | 2,500 VAC, 50/60 Hz, 1 minute (impulse voltage) | 2,000 VAC, 50/60 Hz, 1 minute | 2,000 VAC, 50/60 Hz, 1 minute |
| | Between each terminal and non-current carrying metallic parts | 2,500 VAC, 50/60 Hz, 1 minute (impulse voltage) | 2,000 VAC, 50/60 Hz, 1 minute | 2,000 VAC, 50/60 Hz, 1 minute |
| Insulation resistance | | 100 MΩ min. (at 500 VDC) | | |
| Vibration resistance | Malfunction | 1.5 mm double amplitude, 10 to 55 Hz | | |
| Shock resistance | Malfunction | 150 m/s ² max. | | |
| Ambient operating temperature | | -10 to 55°C (with no icing or condensation) | | |
| Ambient operating humidity | | 35% to 85% | | |
| Ambient storage temperature | | -25 to 65°C (with no icing or condensation) | | |
| Protection against electric shock | | Class II (double insulation) | | |
| Pollution degree (operating environment) | | 3 (EN 60947-5-1) | | |
| Conditional short-circuit current | | 100 A (EN 60947-5-1) | | |

Note: The timing of contact outputs for two or more circuits is not synchronized. Confirm performance before application.

A4EG

Structure and Nomenclature

Structure

A4EG-C000041

A4EG-BE2R041
A4EG-BM2B041

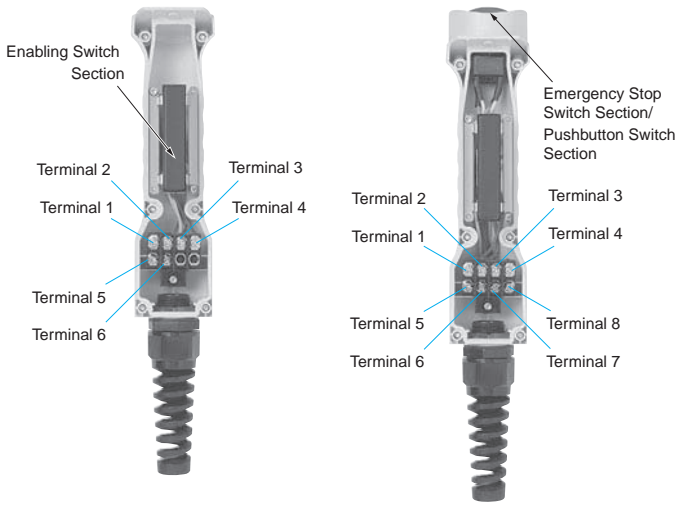

Three Positions: OFF - ON - OFF

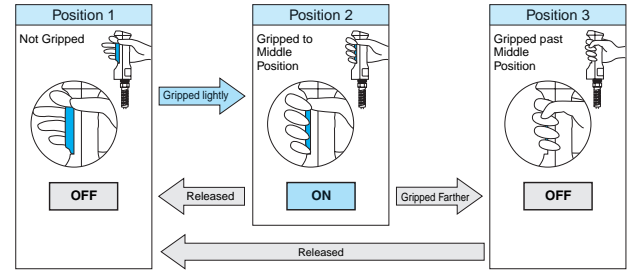

Contact Configuration

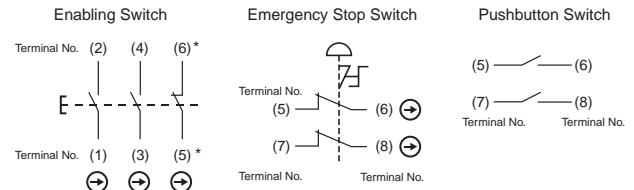

* Terminal No. (5), (6): A4EG-C000041 only

Contact Forms

Operating Patterns

A4EG-C000041

| Operation | Terminal No. | Position 1 | Position 2 | Position 3 |
|---------------|--------------|------------|------------|------------|
| Enable output | 1 to 2 | | | ⊖ |
| | 3 to 4 | | | ⊖ |
| Grip output | 5 to 6 | | | ⊖ |

A4EG-BE2R041

| Operation | Terminal No. | Position 1 | Position 2 | Position 3 |
|---------------|--------------|------------|------------|------------|
| Enable output | 1 to 2 | | | ⊖ |
| | 3 to 4 | | | ⊖ |

| Pushbutton switch | Terminal No. | Operation | Contact |
|------------------------------|--------------|--------------------|----------|
| Emergency stop switch output | 5 to 6 | Operation (push) | ON → OFF |
| | 7 to 8 | Reset (turn reset) | OFF → ON |

A4EG-BM2B041

| Operation | Terminal No. | Position 1 | Position 2 | Position 3 |
|---------------|--------------|------------|------------|------------|
| Enable output | 1 to 2 | | | ⊖ |
| | 3 to 4 | | | ⊖ |

| Pushbutton switch | Terminal No. | Operation | Contact |
|--------------------------|--------------------------------|-----------|----------|
| Pushbutton switch output | 5 to 6 (pushbutton switch A) * | Push | OFF → ON |
| | 7 to 8 (pushbutton switch B) * | Push | OFF → ON |

* Refer to *Dimensions* on page 7 for information on the positions of pushbutton switches A and B.

□ OPEN ON: CLOSED
■ CLOSED OFF: OPEN

Note: 1. The contact ON/OFF timing is not synchronized. Confirm performance before application.
2. Direct opening only during grip.

Operating Characteristics

Chart (Enabling Switch Section)

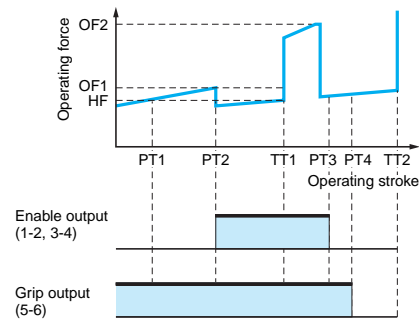

Operating Stroke (Enabling Switch Section)

| Operating characteristics | Specified value |
|--------------------------------|--------------------|
| Enable output (ON) | PT2 max. 3.6 mm |
| Max. enable holding position | TT1 Approx. 4.2 mm |
| Enable direct opening position | PT3 max. 6.0 mm |
| Max. stroke | TT2 Approx. 6.7 mm |

Operating Force (Enabling Switch Section: Reference Values)

| Operating characteristics | Specified value |
|---------------------------|------------------|
| Enable operating force | OF1 max. 14 N |
| Enable holding force | HF * Approx. 8 N |
| Grip operating force | OF2 max. 40 N |

* HF: Holding force

Operating Force (Emergency Stop Switch Section: Reference Values)

| Operating characteristics | Specified value |
|---------------------------|-----------------|
| Operating force | OF max. 14.7 N |
| Reset force | RF max. 0.1 N·m |

Operating Force (Pushbutton Switch Section: Reference Value)

| Operating characteristics | Specified value |
|---------------------------|-----------------|
| Operating force | OF max. 4 N |

Dimensions

Enabling Grip Switches

A4EG-C000041

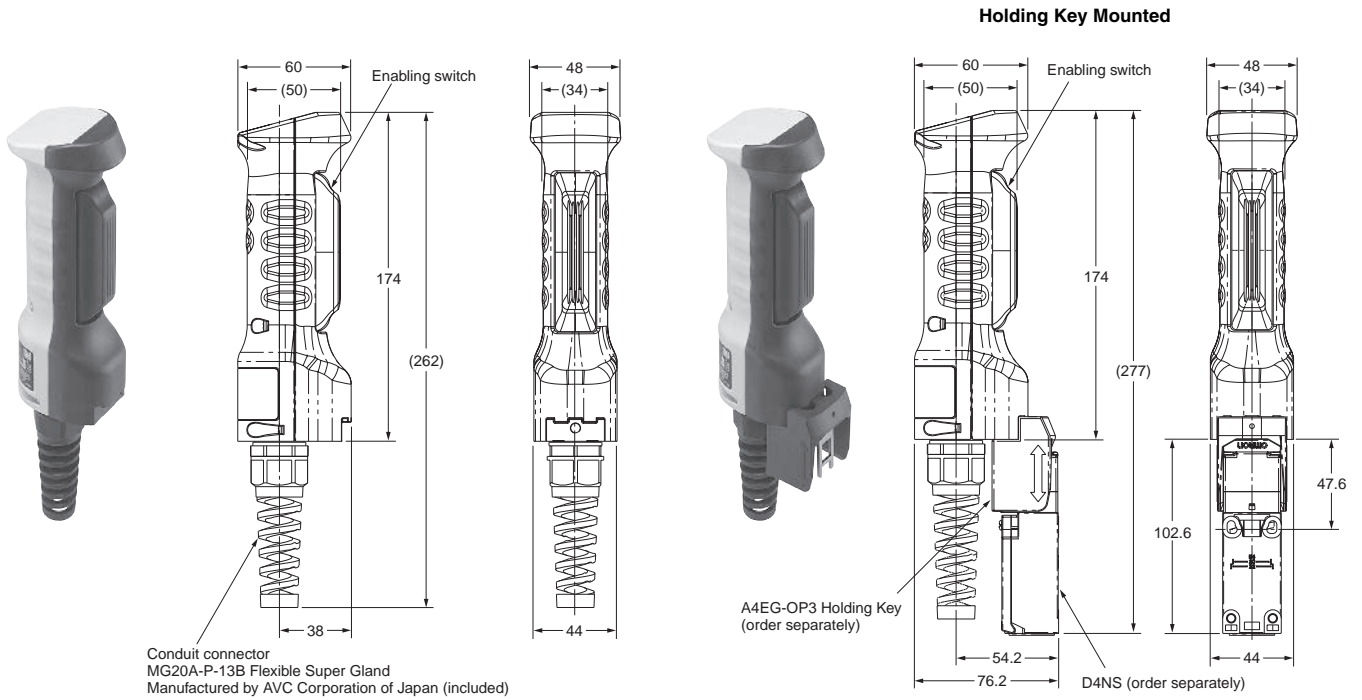

A4EG-BE2R041

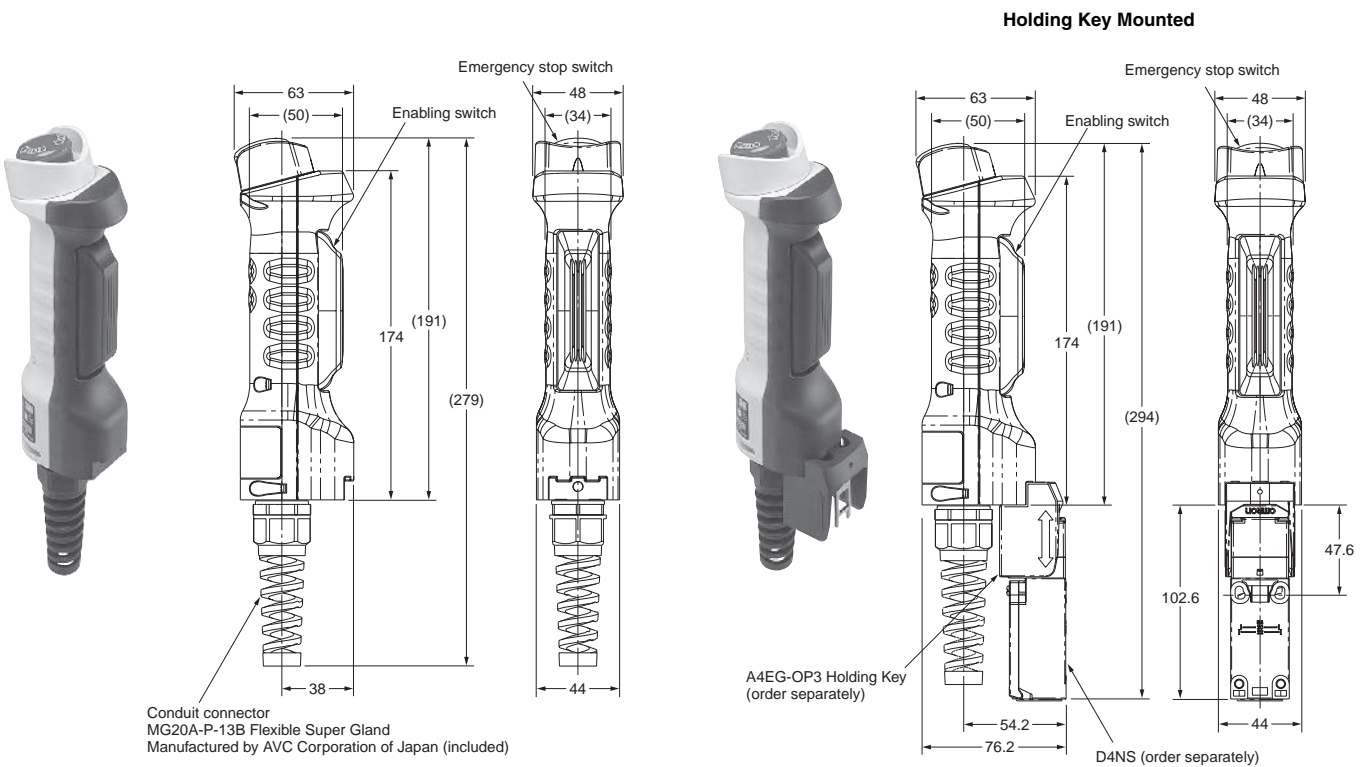

A4EG

A4EG-BM2B041

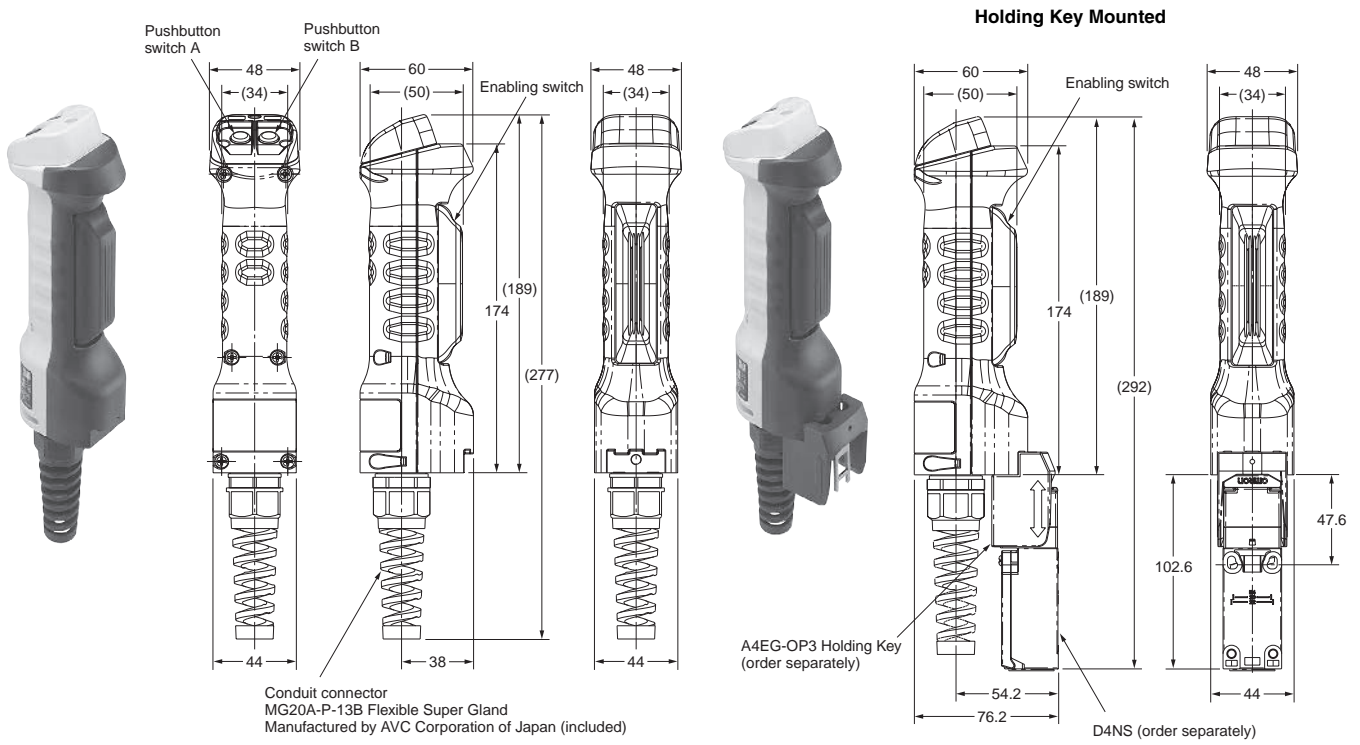

Accessories (Order Separately)

Rubber Cover (Replacement Part)

A4EG-OP1



Mounting Bracket (for Securing the A4EG)

A4EG-OP2

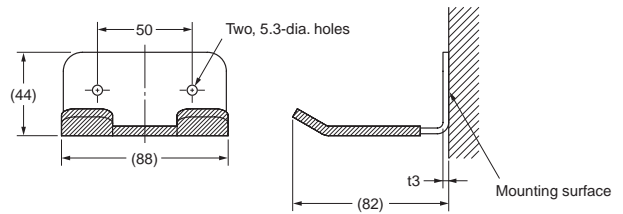

Enabling Grip Switch Mounted

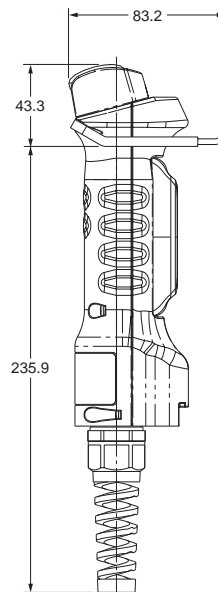

Note: The screws are not included.

Application Examples

Application Examples

Machining Equipment Maintenance Mode

- Switching between normal operation mode and maintenance mode is performed manually.
- In normal operation mode, the Safety Door Switch is enabled, and in maintenance mode, the Enabling Grip Switch is enabled.

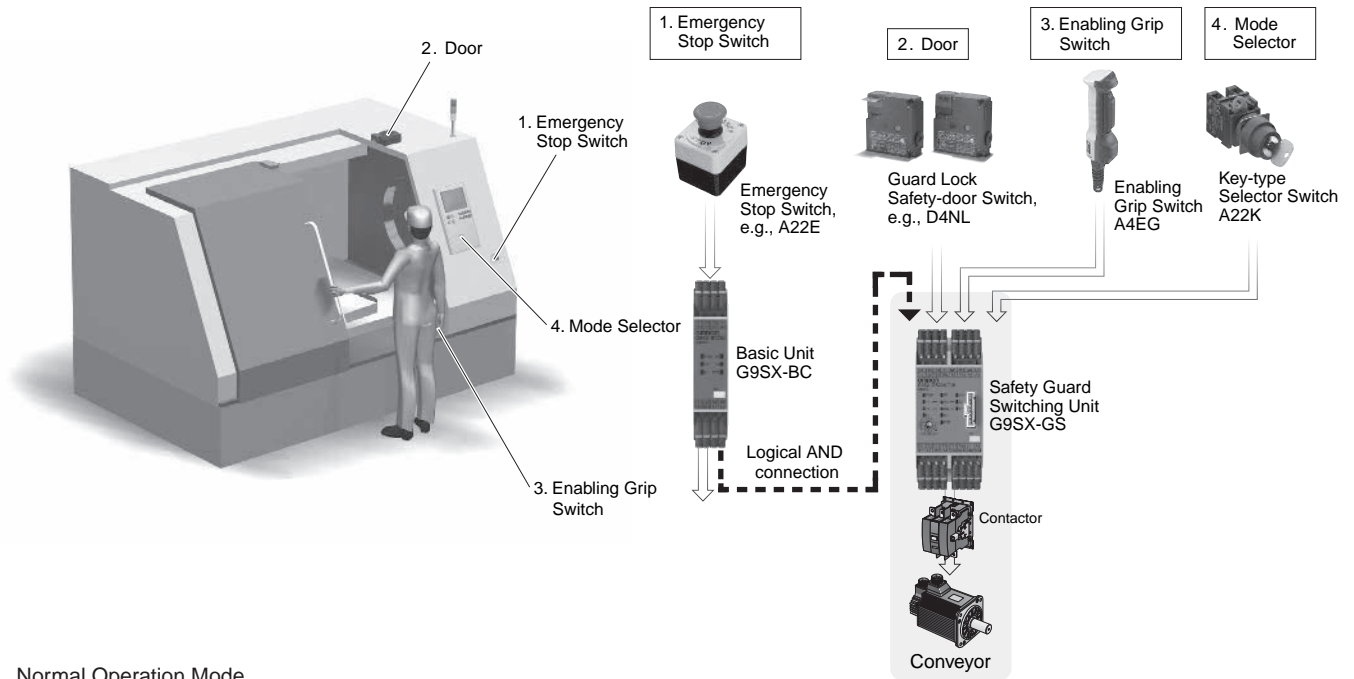

Normal Operation Mode

- Emergency Stop Switch** — When pressed, processing will stop.
- Door** — When the door is opened, processing will stop.
- Enabling Grip Switch** — The Enabling Grip Switch will be disabled.

Maintenance Mode

- Emergency Stop Switch** — When pressed, processing will stop.
- Door** — The Door Switch will be disabled.
- Enabling Grip Switch** — Processing will be possible only when the operator is gripping the Enabling Grip Switch.

Note: For information on the G9SX-GS, refer to *Safety Components Series Catalog* (Cat. No. Y106) and *G9SX User's Guide* (Cat. No. Z255).

Wiring Example

| PL/safety category | Model | Stop category | Reset |
|--------------------|--|---------------|-------|
| PLe/4 equivalent | Safety Key Selector Switch A22TK-2□□-11 (SPST-NO/SPST-NC type) Guard lock Safety-door Switch D4NL-□□A□□-□, -□□B□□, -□□□□ (Mechanical Lock Type) Enabling Grip Switch A4EG Safety Guard Switching Unit G9SX-GS226-T15 Flexible Safety Unit G9SX-BC202 (24 VDC) | - | - |

- Note:**
- The above PL is only the evaluation result of the example. The PL must be evaluated in an actual application by the customer after confirming the usage conditions.
 - The above PL is the evaluation result concerning the mode selection. The PL for enabling function, guard, emergency stop switch, and other safety functions must be separately evaluated.

Application Overview

- Switching between normal operation mode and maintenance mode is performed manually.
- In normal operation mode, the power supply to the motor M2 is turned OFF when the guard is opened.
- In maintenance mode, the power supply to the motor M2 is turned OFF when the enabling switch is released or strongly gripped.
- In normal operation mode and maintenance mode, the power supply to the motor M1 and M2 is turned OFF when the emergency stop switch is pressed.

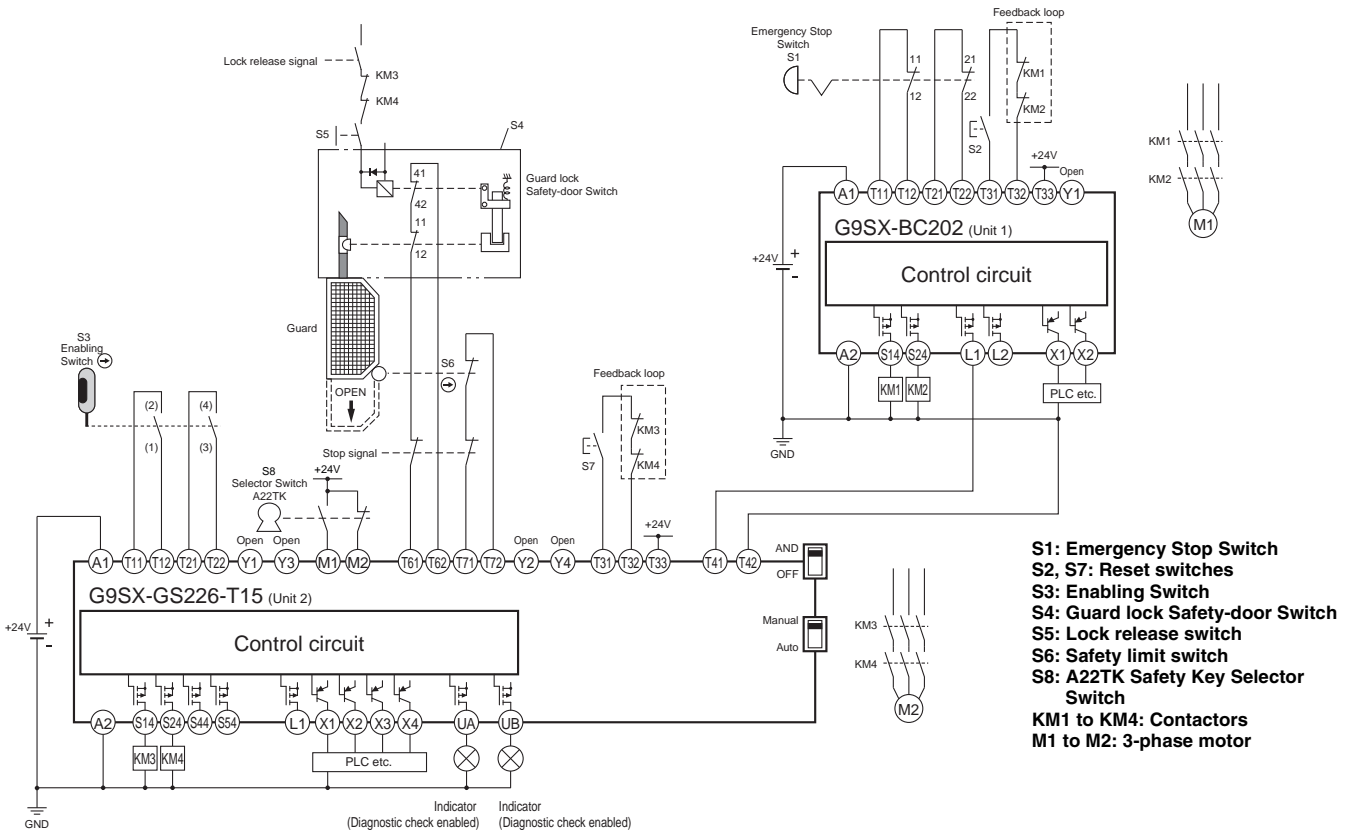

Timing Chart

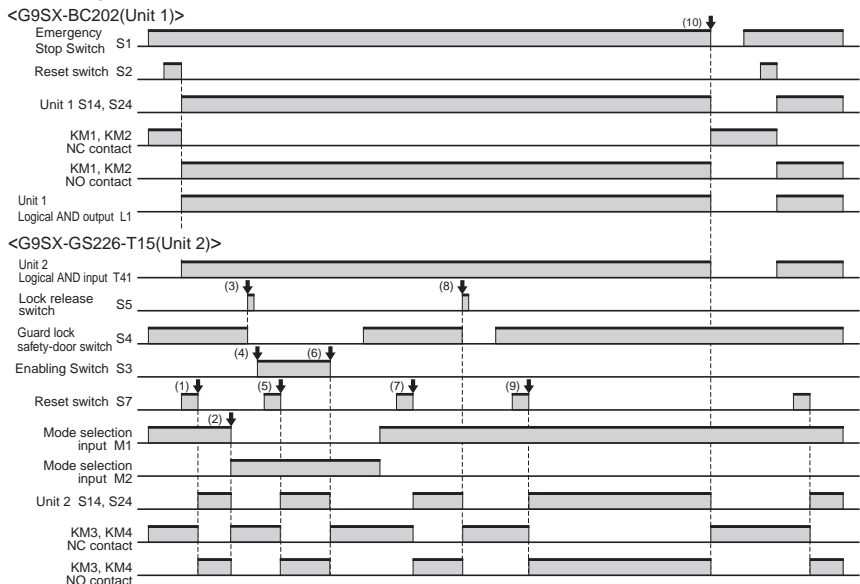

- The G9SX-GS starts in operation mode.
- The mode switches to maintenance mode.
- The operator opens the guard and performs maintenance work.
- The Enabling Switch is gripped to the middle position.
- The G9SX-GS starts in maintenance mode.
- The G9SX-GS will stop when the Enabling Switch is released or gripped.
- The G9SX-GS will start again after the guard is closed and the mode is switched to operation mode.
- The G9SX-GS will stop and the guard can be opened when the stop signal is input while in operation mode.
- The guard is closed and the G9SX-GS starts again.
- All the units will stop if the emergency stop is pressed.

Safety Precautions

⚠ WARNING

Always verify the operation of the safety functions before starting the system. Not doing so may result in the safety functions not performing as expected if the wiring or settings are incorrect or the switches have failed.



Do not drop the switch. Doing so may damage the switch and the system may continue to operate, possibly causing injury or death.



Precautions for Safe Use

- This product is a switch for teaching the machine such as robot in hazardous area. The machine is allowed to operate only when operating the switch continuously. Configure the system so that the machine can be operated only at position 2.
- Apply load current not to exceed the rated value.
- Do not use the switch submerged in oil or water or in locations continuously subject to splashes of oil or water. Doing so may result in oil or water entering the switch.
- Do not use the switch in locations where explosive or flammable gasses may be present.
- Mount the switch securely to prevent it from falling. Otherwise, injuries may occur.
- The durability of the switch is greatly influenced by the switching conditions. Always test the switch under actual conditions before application and use it in a switching circuit for which there are no problems with performance.
- Always attach the cover after completing wiring and before using the switch. Electric shock may occur if the switch is used without the cover attached.
- The user must not maintain or repair equipment incorporating the switch. Contact the manufacturer of the equipment for any maintenance or repairs required.
- Do not disassemble or remodel the switch in any case, or the switch will not operate normally.
- Do not override by inserting the Holding Key itself in the door switch.
- Configure the circuit so that the machine does not operate when operating the Enabling Switch while the Holding Key is being inserted in the door switch.
- Do not impose excessive vibration or shock on the Door Switch while the Holding Key is inserted. Excessive vibration or shock may cause the Switch to fail or break.
- Do not incline and pull the switch body or do not impose shock on the switch body in the directions shown with the arrows in Fig.1. Otherwise, the switch may be damaged and may not operate properly.
- Refer to the *D4NS Safety-door Switch Datasheet and Instruction Sheet* about the storage, ambient conditions, the details and handling of the Switch.

Fig. 1

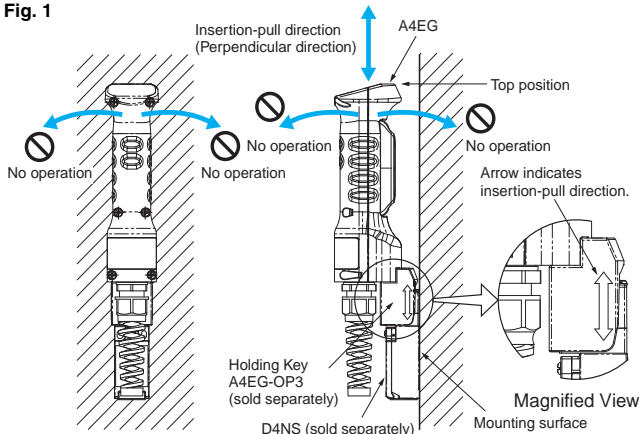

- Do not contact the enabling switch section to the mounting bracket in Fig.2. Doing so may result in malfunction.

Fig. 2

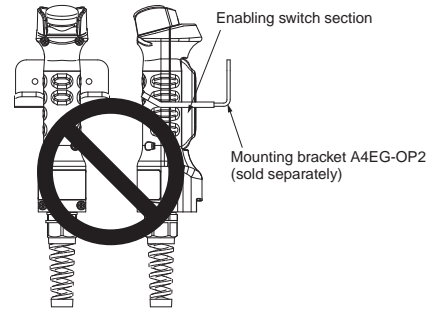

Precautions for Correct Use

- Do not hold the Enabling Switch Device at Position 2 by any other methods except for handling. Otherwise, the original function of the Enabling Switch Device is not worked.

Operating Environment

- This switch is designed for use indoors. Using the switch outdoors may damage it.
- The switch contacts can be used with either standard loads or microloads. Once the contact be used to switch smaller loads. The contact surfaces will become rough once they have been used and contact reliability for smaller loads may be reduced.
- Do not use the switch in the following locations.
 - Locations where the interior of the Protective Door may into direct contact with cutting chips, metal filings, oil chemicals
 - Locations subject to detergents, thinners, or other solvents
 - Locations subject to sudden temperature changes
 - Locations subject to high humidity and condensation
 - Locations subject to severe vibration
- Do not use the switch where corrosive gasses (e.g., H₂S, SO₂, NH₃, HNO₃, or Cl₂) are present or in locations subject to high temperature and humidity. Doing so may result in damage to the switch as a result of contact failure or corrosion.
- Do not store the switch where corrosive gasses (e.g., H₂S, SO₂, NH₃, HNO₃, or Cl₂) or dust are present or in high temperature and humidity.
- If the switch is not turned ON and OFF for a long period of time, contact resistance may be increased or continuity failure may occur due to contact oxidation.

Mounting Method

Specified Tightening Torque

Loose screws may result in malfunction. Tighten the screws at the specified torques.

| Item | Specified torque |
|--|------------------|
| Cover mounting screw | 1.1 to 1.3 N-m |
| Terminal screw | 0.4 to 0.5 N-m |
| Holding Key mounting screw | 0.5 to 0.7 N-m |
| Conduit Connector mounting (Conforming spanner 27 mm (width across flats)) | 2.0 to 2.4 N-m |
| Mounting Bracket | 2.4 to 2.8 N-m |

Cover Mounting

- Dislocation of the seal rubber or foreign substance on the seal rubber reduces seal performance of the switch. Mount the cover after confirming that there is no abnormality on the seal rubber. If the seal rubber cracks or breaks, replace the Cover with a new one (A4EG-OP1 Rubber Cover, separately sold).
- Do not touch the rubber boot with sharp objects. Otherwise, the rubber boot may break and the operating characteristics and the seal performance may not be satisfied.

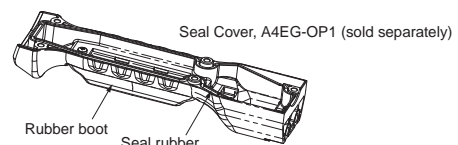

Installing Mounting Bracket

- Securely install the Mounting Bracket using M5 screws and washers and tighten them to a torque of 2.4 to 2.8 N·m.

Holding Key Type (sold separately)

- Use the A4EG-OP3 Holding Key when using the A4EG combining with the door switch.
- Use the D4NS Safety-door Switch.
- Loose screws may result in malfunction. Tighten the screws at the specified torques. Adhesive is recommended to prevent screws from being loose.

The specified torque: 0.5 to 0.7 N·m (Mounting screw, 2pcs.)

- Do not impose excessive force on the tip of the Holding Key or do not drop the switch body when the Holding Key is mounted on the switch body. Otherwise the Holding Key may deform or break. Stop using in case that deformation or breakage of the Holding Key occurs.
- Use the provide Spring washers and Mounting screws when mounting the Holding Key. Fit a tip of a slotted-screw driver on the head of the Mounting screw as shown in the following figure when tightening Mounting screws. The Mounting screws cannot be released once tightened.

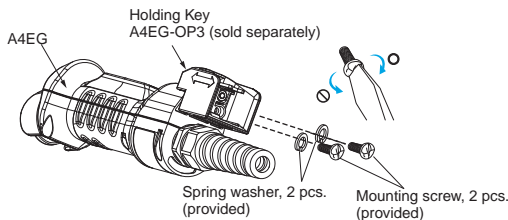

- As shown in figure 1 in *Precautions for Safe Use*, install the D4NS so that its mounting surface is above the highest part of the A4EG.
- As shown in figure 1 in the *Precautions for Safe Use*, use the Holding Key inserted vertically to the insert hole.

Using the A4EG-BE2R041 (Enabling Grip Switch Equipped with an Emergency Stop Button)

If the A4EG is installed in a machine, do not use the A4EG alone as an emergency stop switch or as an emergency shutoff switch as specified by SEMI-S2.

SEMI-S2 specifies the installation of emergency shutoff switches at specified intervals on equipment. The A4EG can be removed from the equipment, and so may not satisfy the requirements of SEMI. Use the A4EG in combination with emergency stop switches or emergency shutoff switches that are installed at fixed positions.

Wiring

- Confirm that safety is satisfied on the operation of the equipment to wire.
- Do not put the electric power when wiring. Otherwise electric shock may occur.
- Use an adequate diameter of cable. The seal performance is reduced when the diameter is smaller than the adequate diameter.
- Use the conforming sizes of lead wires to the apply voltage and current.

Conforming cable size

Recommended multi-wire cable size: AWG20 to 18
(0.5 to 0.75 mm²)

Recommended cable diameter: 8.0 to 13 mm
(used with provided Conduit Connector)

- Do not pull the lead wires with excessive force. Doing so may disconnect them.

- Do not pull the cable when the Enabling Switch Device is hung on the Bracket.

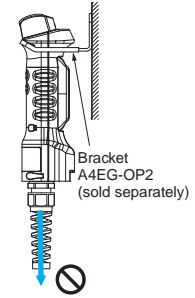

- Use crimp terminals with insulator tube for wiring. Recommended crimp terminal (Ring tongue terminal, Nylon-insulated): J.S.T. Mfg Co. FN1.25-3.7 (F Type)/N1.25-3.7 (Straight Type)

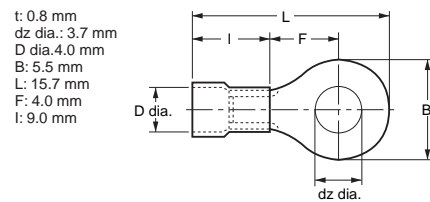

- Cut and crimp the lead wires in length as shown in the following table. Otherwise, excess length may cause the cover to rise and not fit properly.

Lead Wire Lengths

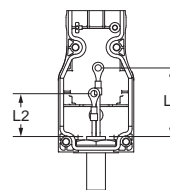

Terminal Arrangement

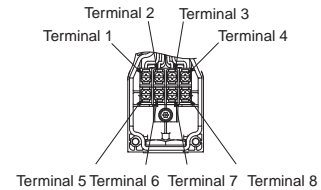

| Length of lead wires | Terminal No. | 1-4 | 5-8 |
|---|--------------|---------|---------|
| L1/L2 (Length to the centers of crimp terminals) | | 40±2 mm | 25±2 mm |

- Do not let particles such as small piece of lead wire in the switch body when wiring.

Terminal No. and Circuit Configuration

| Model | Circuit | Terminal No. |
|--------------|---|--------------|
| A4EG-C000041 | Enable output | 1-2, 3-4 |
| | Grip output | 5-6 |
| A4EG-BE2R041 | Enable output | 1-2, 3-4 |
| | Emergency Stop Pushbutton Switch output | 5-6, 7-8 |
| A4EG-BM2B041 | Enable output | 1-2, 3-4 |
| | Pushbutton Switch output | 5-6, 7-8 |

- Assemble all of the parts without leaving any parts as shown in the following figure when mounting Conduit Connector. Mount Rubber packing, Conduit part, Cable Seal part and Spiral Nut part in order.

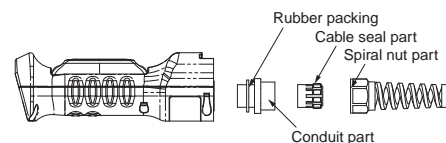

- Both of the switches is ON when pushing the two push buttons simultaneously. Confirm that safety is satisfied on the operation of the equipment to wire. (A4EG-BM2B041)
- Perform maintenance inspections periodically.

MEMO

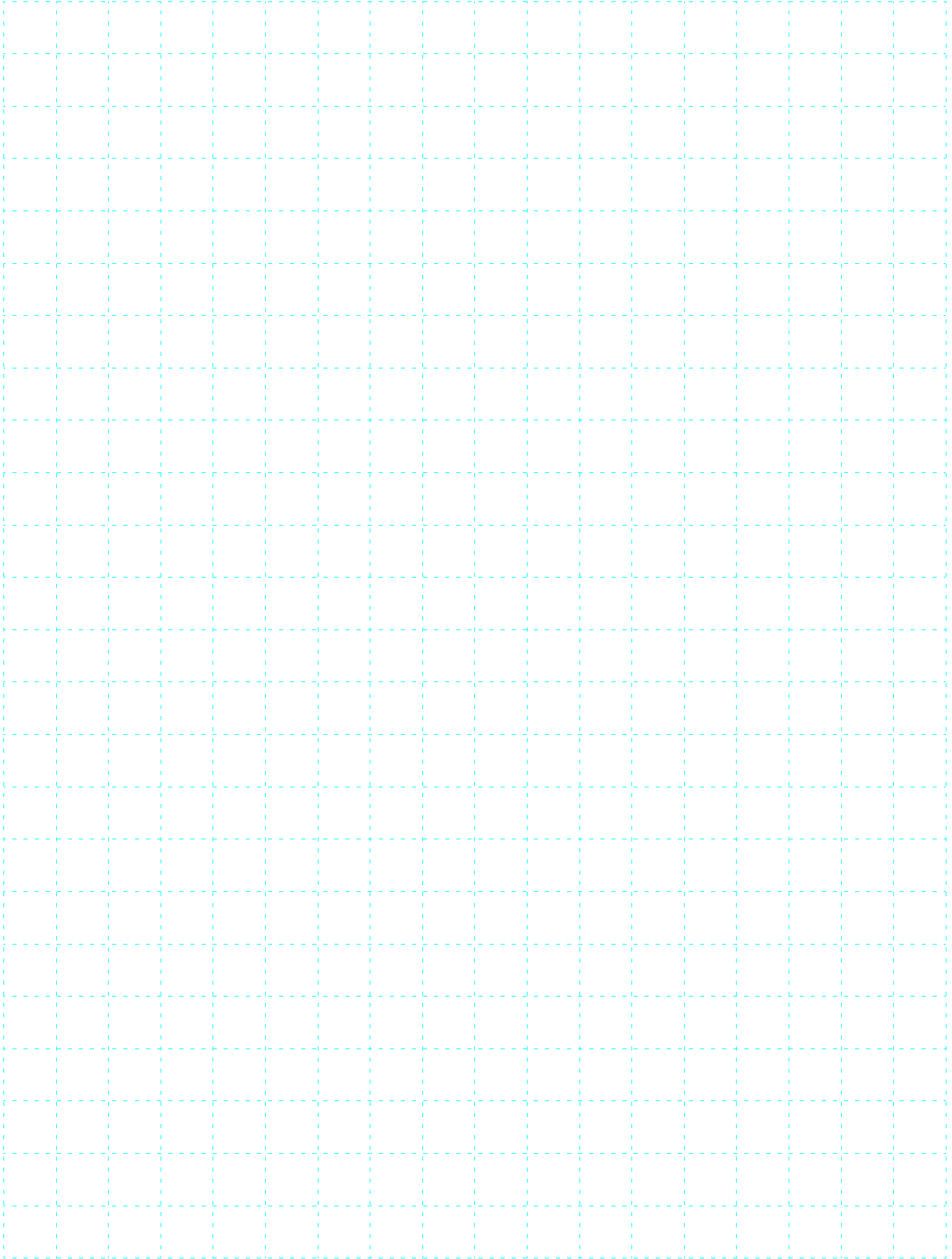

A large grid of 15 columns and 25 rows, intended for taking notes or calculations. The grid is formed by dashed light blue lines.

OMRON Corporation Industrial Automation Company
Tokyo, JAPAN

Contact: www.ia.omron.com

Regional Headquarters

OMRON EUROPE B.V.

Wegalaan 67-69-2132 JD Hoofddorp
The Netherlands
Tel: (31)2356-81-300/Fax: (31)2356-81-388

OMRON SCIENTIFIC TECHNOLOGIES INC.

6550 Dumbarton Circle, Fremont
CA 94555-3605 U.S.A.
Tel: (1) 510-608-3400/Fax: (1) 510-744-1442

OMRON ASIA PACIFIC PTE. LTD.

No. 438A Alexandra Road # 05-05/08 (Lobby 2),
Alexandra Technopark,
Singapore 119967
Tel: (65) 6835-3011/Fax: (65) 6835-2711

OMRON (CHINA) CO., LTD.

Room 2211, Bank of China Tower,
200 Yin Cheng Zhong Road,
PuDong New Area, Shanghai, 200120, China
Tel: (86) 21-5037-2222/Fax: (86) 21-5037-2200

Authorized Distributor:

© OMRON Corporation 2009 All Rights Reserved.
In the interest of product improvement,
specifications are subject to change without notice.

CSM_5_1_1213
Cat. No. C142-E1-01

Printed in Japan
1007-3M (1007) (H)