

FMEN-210A

March, 2006

■General Description

FMEN-210A is a High Voltage (100V) Schottky Barrier Diode, and has achieved low leakage current and low VF by selecting the best barrier metal.

■Applications

- DC-DC converters
- AC adapter
- High frequency rectification circuit

■Features

- High Voltage 100V guaranteed.
- Steady operation is possible even at the high temperature by the low leakage current.
- Super-high speed & low switching noise.
- Low forward voltage drop.

■Package---TO220F

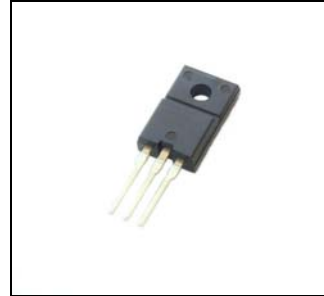

■Key Specifications

Item	Unit	Rating	Conditions
V_{RM}	V	100	
V_F	V	0.85	$I_F=5.0A$
$I_{F(AV)}$	A	10	

Typical Characteristics

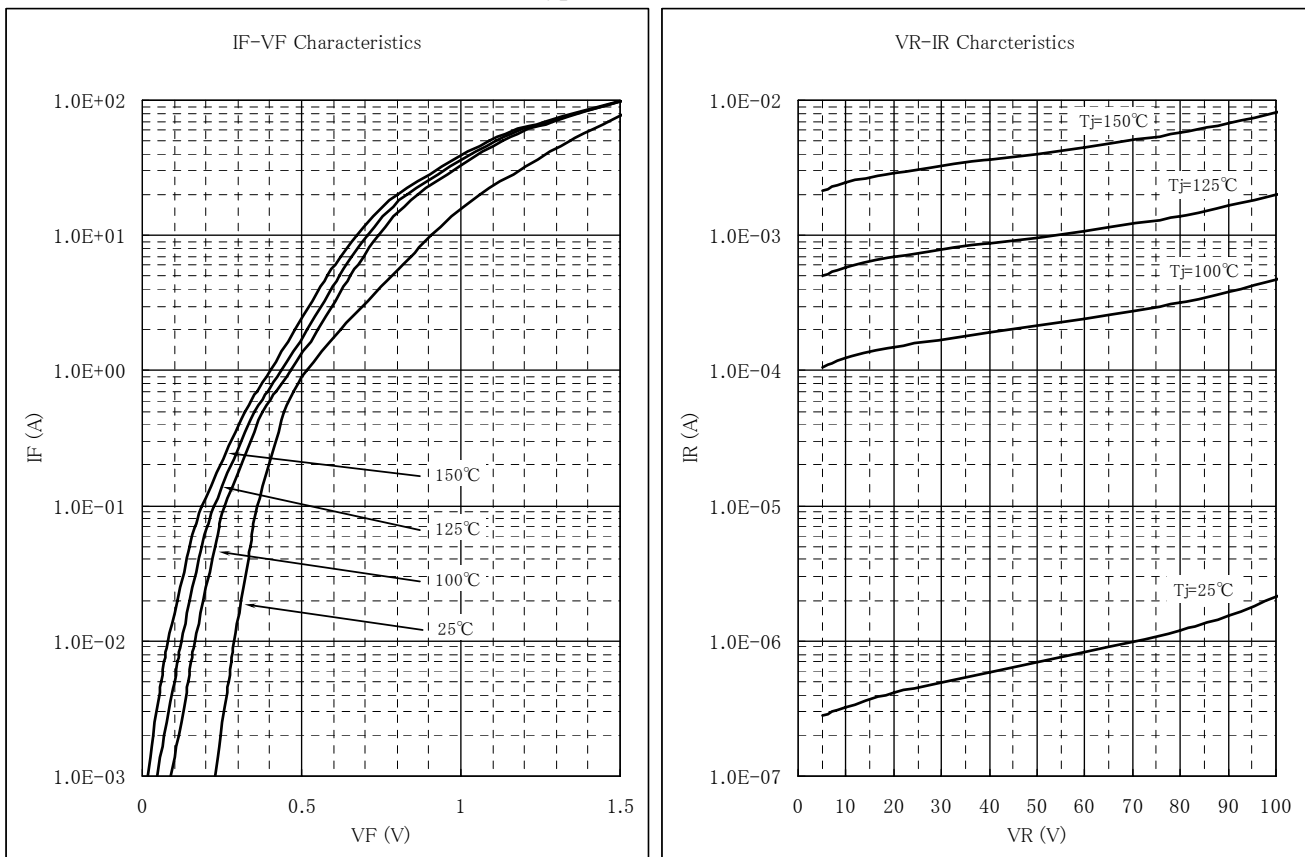

★ Absolute maximum ratings

No.	Parameter	Symbol	Unit	Rating	Conditions
1	Transient Peak Reverse Voltage	V_{RSM}	V	100	
2	Peak Reverse Voltage	V_{RM}	V	100	
3	Average Forward Current	$I_{F(AV)}$	A	10	
4	Peak Surge Forward Current	I_{FSM}	A	100	Half sinewave, one shot
5	I^2t Limiting Value	I^2t	A^2s	50	$1\text{msec} \leq t \leq 10\text{msec}$
6	Junction Temperature	T_j	$^{\circ}C$	-40 to +150	
7	Storage Temperature	T_{stg}	$^{\circ}C$	-40 to +150	

No.1,2,4&5 show ratings per one chip.

★ Electrical characteristics($T_a=25^{\circ}C$, unless otherwise specified)

No.	Parameter	Symbol	Unit	Value	Conditions
1	Forward Voltage Drop	V_F	V	0.85 max.	$I_F=5.0A$
2	Reverse Leakage Current	I_R	μA	100 max.	$V_R=V_{RM}$
3	Reverse Leakage Current Under High Temperature	$H \cdot I_R$	mA	50 max.	$V_R=V_{RM}$, $T_j=150^{\circ}C$
4	Thermal Resistance	$R_{th(j-c)}$	$^{\circ}C/W$	4.0 max.	Between Junction and case

No.1,2,&3 show characteristics per one chip.

FMEN-210A

March, 2006

★ Characteristics

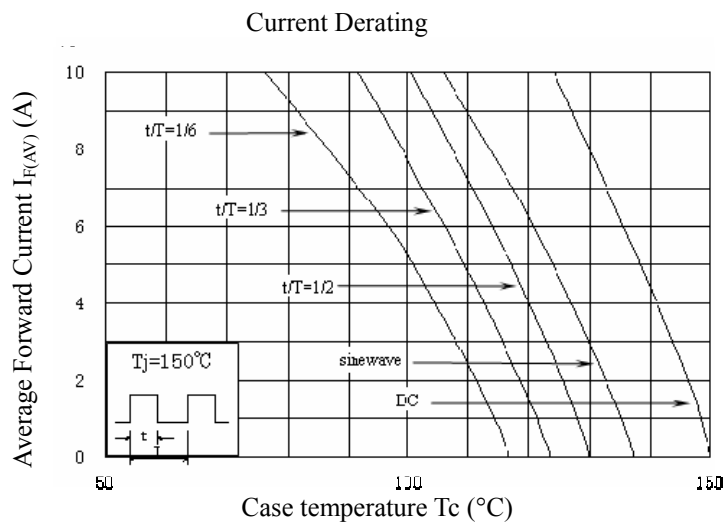
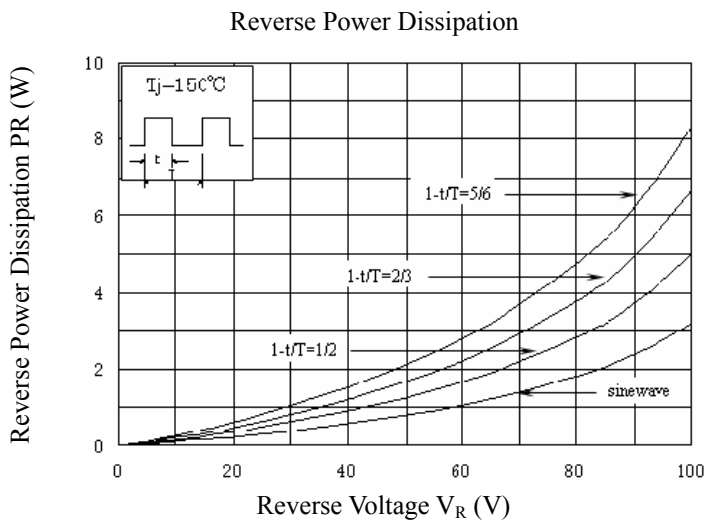
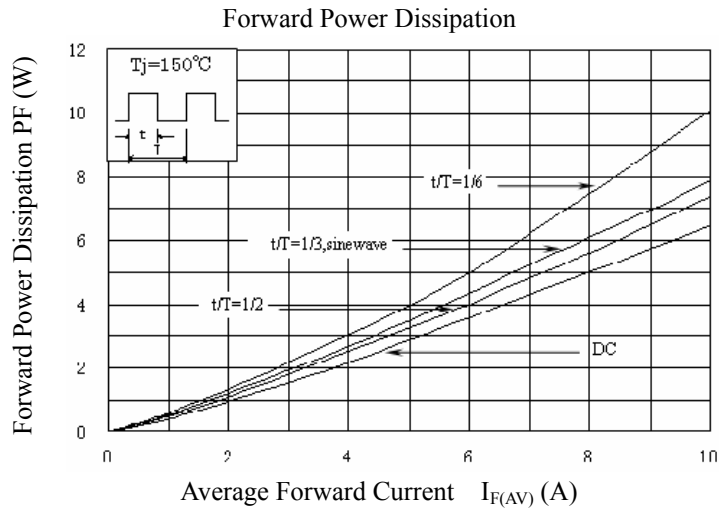

FMEN-210A

March, 2006

★ External Dimensions (Unit: mm)

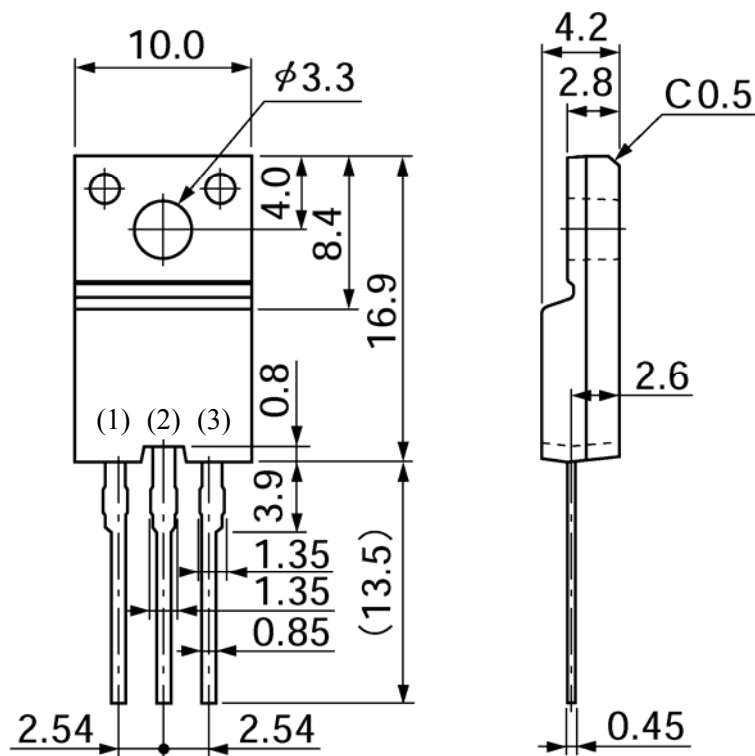

Tolerance: ± 0.2

★ Connection Diagram

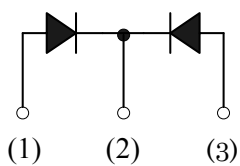

<Worldwide Contacts>

Asia Pacific

China

Sanken Electric Hong Kong Co., Ltd.

Suite 1026 Ocean Centre, Canton Road, Tsimshatsui, Kowloon, Hong Kong

Tel: 852-2735-5262

Fax: 852-2735-5494

Sanken Electric (Shanghai) Co., Ltd.

Room3202, Maxdo Centre, Xingyi Road 8, Changning district, Shanghai, China

Tel: 86-21-5208-1177

Fax: 86-21-5208-1757

Taiwan Sanken Electric Co., Ltd.

Room 1801, 18th Floor, 88 Jung Shiau East Road, Sec. 2, Taipei 100, Taiwan R.O.C.

Tel: 886-2-2356-8161

Fax: 886-2-2356-8261

India

Saket Devices Pvt. Ltd.

Office No.13, First Floor, Bandal - Dhankude Plaza, Near PMT Depot, Paud Road, Kothrud, Pune - 411 038, India

Tel: 91-20-5621-2340

91-20-2528-5449

Fax: 91-20-2528-5459

Japan

Sanken Electric Co., Ltd. Overseas Sales Headquarters

Metropolitan Plaza Bldg. 1-11-1 Nishi-Ikebukuro, Toshima-ku, Tokyo 171-0021, Japan

Tel: 81-3-3986-6164

Fax: 81-3-3986-8637

Korea

Sanken Electric Korea Co., Ltd.

Mirae Asset Life Bldg. 6F, 168 Kongduk-dong, Mapo-ku, Seoul, 121-705, Korea

Tel: 82-2-714-3700

Fax: 82-2-3272-2145

Singapore

Sanken Electric Singapore Pte. Ltd.

150 Beach Road, #14-03 The Gateway West, Singapore 189720

Tel: 65-6291-4755

Fax: 65-6297-1744

FMEN-210A

March, 2006

Europe

United Kingdom

Sanken Power Systems (UK) Limited

Pencoed Technology Park, Pencoed, Bridgend CF35 5HY. UK

Tel: 44-1656-869-100

Fax: 44-1656-869-162

North America

United States

Allegro MicroSystems, Inc.

115 Northeast Cutoff, Worcester, Massachusetts 01606, U.S.A.

Tel: 1-508-853-5000

Fax: 1-508-853-3353

Allegro MicroSystems, Inc. (Southern California)

14 Hughes Street, Suite B105, Irvine, CA 92618

Tel: 1-949-460-2003

Fax: 1-949-460-7837

CAUTION / WARNING

- The information in this publication has been carefully checked and is believed to be accurate; however, no responsibility is assumed for inaccuracies.
 - Sanken reserves the right to make changes without further notice to any products herein in the interest of improvements in the performance, reliability, or manufacturability of its products.
Before placing an order, Sanken advises its customers to obtain the latest version of the relevant information to verify that the information being relied upon is current.
 - Application and operation examples described in this catalog are quoted for the sole purpose of reference for the use of the products herein and Sanken can assume no responsibility for any infringement of industrial property rights, intellectual property rights or any other rights of Sanken or any third party which may result from its use.
 - When using the products herein, the applicability and suitability of such products for the intended purpose or object shall be reviewed at the users' responsibility.
 - Although Sanken undertakes to enhance the quality and reliability of its products, the occurrence of failure and defect of semiconductor products at a certain rate is inevitable. Users of Sanken products are requested to take, at their own risk, preventative measures including safety design of the equipment or systems against any possible injury, death, fires or damages to the society due to device failure or malfunction.
 - Sanken products listed in this catalog are designed and intended for the use as components in general purpose electronic equipment or apparatus (home appliances, office equipment, telecommunication equipment, measuring equipment, etc.). Before placing an order, the user's written consent to the specifications is requested.
When considering the use of Sanken products in the applications where higher reliability is required (transportation equipment and its control systems, traffic signal control systems or equipment, fire/crime alarm systems, various safety devices, etc.), please contact your nearest Sanken sales representative to discuss and obtain written confirmation of your specifications. The use of Sanken products without the written consent of Sanken in the applications where extremely high reliability is required (aerospace equipment, nuclear power control systems, life support systems, etc.) is strictly prohibited.
 - Anti radioactive ray design is not considered for the products listed herein.
 - This publication shall not be reproduced in whole or in part without prior written approval from Sanken.
-
- This is notification that you, as purchaser of the products/technology, are not allowed to perform any of the following:
 1. Resell or retransfer these products/technology to any party intending to disturb international peace and security.
 2. Use these products/technology yourself for activities disturbing international peace and security.
 3. Allow any other party to use these products/technology for activities disturbing international peace and security.Also, as purchaser of these products/technology, you agree to follow the procedures for the export or transfer of these products/technology, under the Foreign Exchange and Foreign Trade Law, when you export or transfer the products/technology abroad.
-