

SF2133E

1747.5 MHz SAW Filter

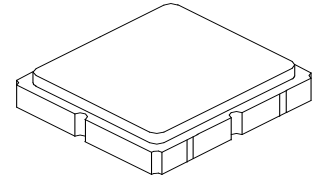

SM3030-6

- Low Loss SAW Filter
- Surface Mount 3.0 x 3.0 mm Package
- Complies with Directive 2002/95/EC (RoHS)



Absolute Maximum Ratings

| Rating | Value | Units |
|--|------------|-------|
| Input Power Level | 5 | dBm |
| DC Voltage on any Non-ground Terminal | 3 | V |
| Operatable Temperature Range | -40 to +90 | °C |
| Storage Temperature Range in Tape and Reel | -40 to +90 | °C |
| Maximum Soldering Profile, 5 cycles/10 seconds maximum | 265 | °C |

Electrical Characteristics

| Characteristic | Sym | Min | | Typ | Max | | Units |
|--|---|------------------|--------------|--------|--------|--------------|-------------------|
| | | @25°C | -20 to +70°C | | @25°C | -20 to +70°C | |
| Center Frequency | f_c | | | 1747.5 | | | MHz |
| Insertion Loss, 1710 to 1785 MHz | IL | | | 2.6 | 3.3 | 4.0 | dB |
| Amplitude Ripple, 1710 to 1785 MHz | | | | 1.7 | 2.0 | 2.5 | dB _{P-P} |
| Attenuation Referenced to 0 dB: | | | | | | | |
| 10 to 1670 MHz | | 15.6 | 15 | 23 | | | dB |
| 1670 to 1690 MHz | | 17.4 | 6 | 24 | | | |
| 1805 to 1880 MHz | | 18.4 | 6 | 24 | | | |
| 1880 to 4500 MHz | | 15.4 | 15 | 25 | | | |
| 4500 to 5000 MHz | | 13.9 | 10 | 14 | | | |
| Input/Output VSWR, 1710 to 1785 MHz | | | | 1.8:1 | 2.49:1 | 2.5:1 | |
| Source Impedance | Z_S | | | 50 | | | Ω |
| Load Impedance | Z_L | | | 50 | | | Ω |
| Case Style | SM3030-6 3.0 x 3.0 mm Nominal Footprint | | | | | | |
| Lid Symbolization (Y=year, WW=week, S=shift) dot=pin 1 indicator | 679, YWWS | | | | | | |
| Standard Reel Quantity | Reel Size 7 Inch | 500 Pieces/Reel | | | | | |
| | Reel Size 13 Inch | 3000 Pieces/Reel | | | | | |

Electrical Connections

| Connection | Terminals |
|-------------|------------|
| Input | 2 |
| Output | 5 |
| Case Ground | All others |

 **CAUTION: Electrostatic Sensitive Device. Observe precautions for handling.**

NOTES:

1. Unless noted otherwise, all specifications apply over the operating temperature range with filter soldered to the specified demonstration board with impedance matching to 50 Ω and measured with 50 Ω network analyzer.
2. Unless noted otherwise, all frequency specifications are referenced to the nominal center frequency, f_c .
3. Rejection is measured as attenuation below the minimum IL point in the passband. Rejection in final user application is dependent on PCB layout and external impedance matching design. See Application Note No. 42 for details.
4. "LRIP" or "L" after the part number indicates "low rate initial production" and "ENG" or "E" indicates "engineering prototypes."
5. The design, manufacturing process, and specifications of this filter are subject to change.
6. Either Port 1 or Port 2 may be used for either input or output in the design. However, impedances and impedance matching may vary between Port 1 and Port 2, so that the filter must always be installed in one direction per the circuit design.
7. US and international patents may apply.
8. Murata, stylized Murata logo, and Murata N.A., Inc. are registered trademarks of Murata Manufacturing Co., Ltd.

F. Frequency Characteristics :
Transfer function

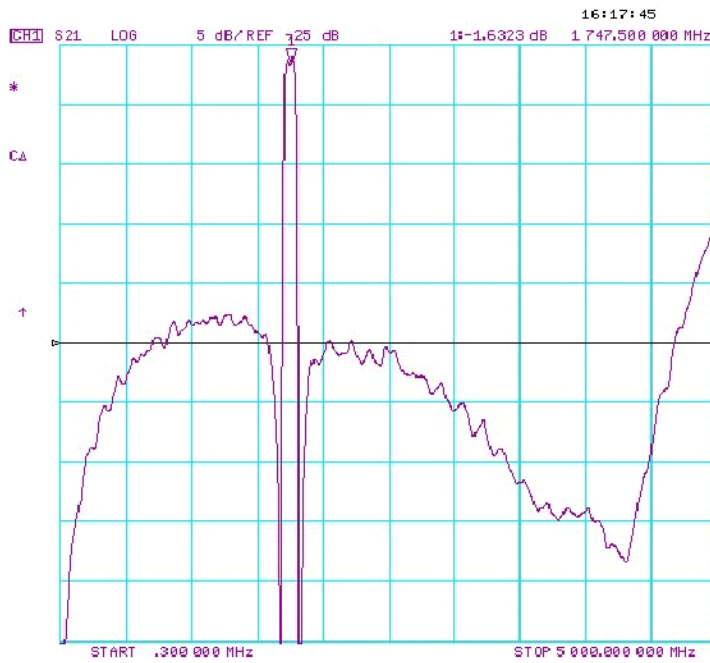
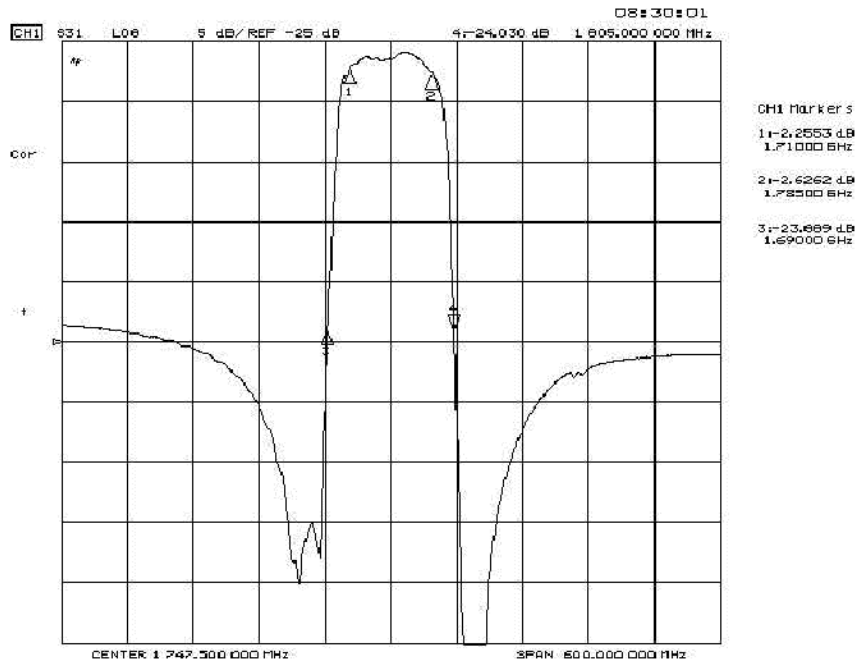

Reflections Functions :

S11

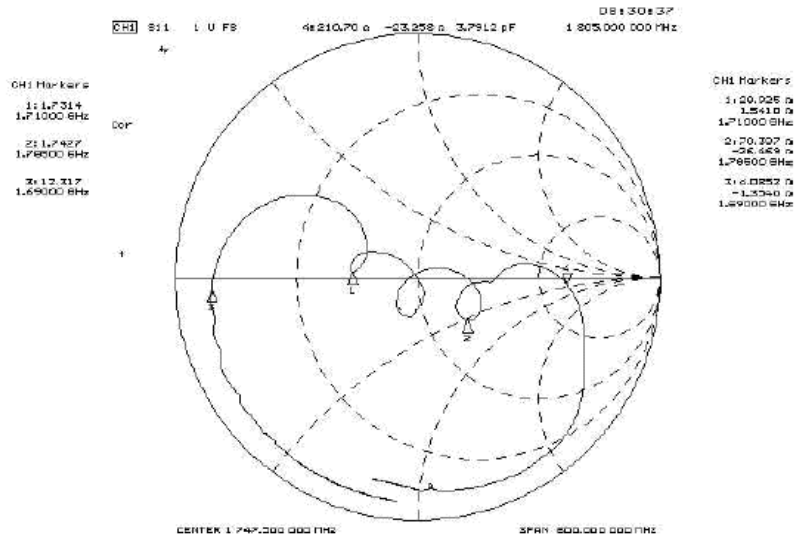
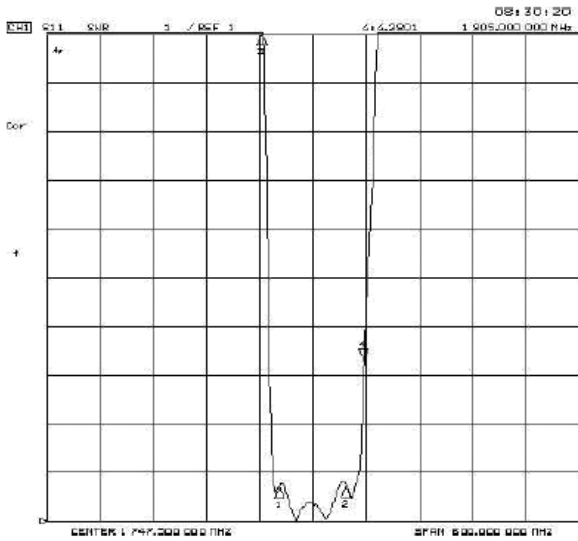

S22

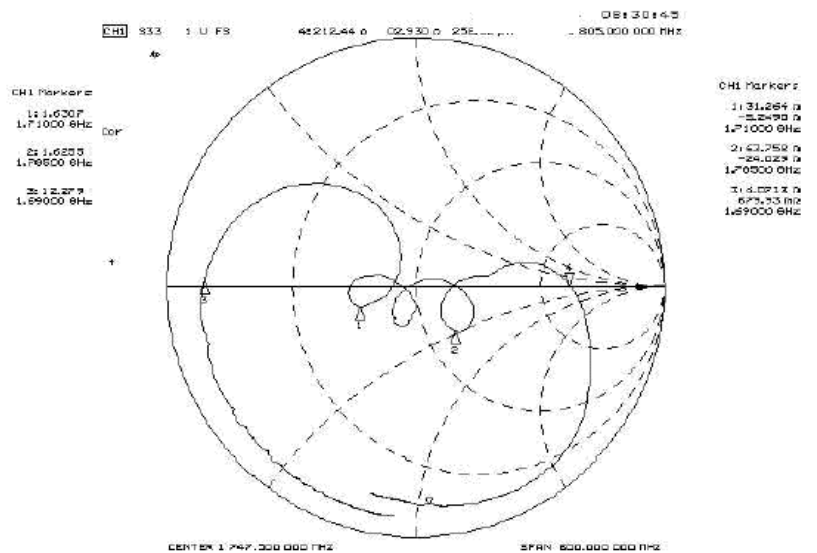
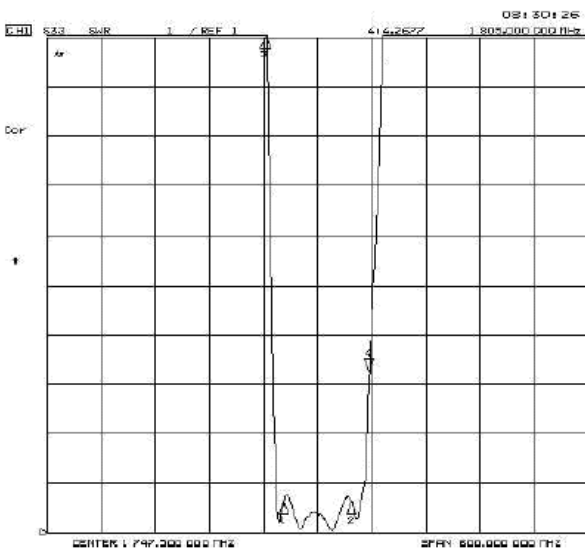

SM3030-6 Case

6-Terminal Ceramic Surface-Mount Case

3.0 X 3.0 mm Nominal Footprint

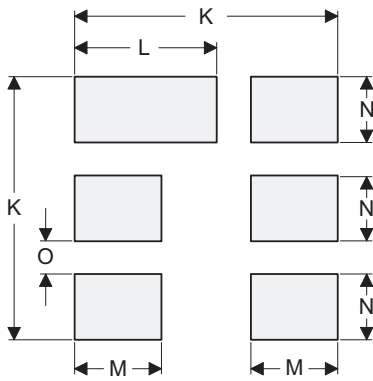
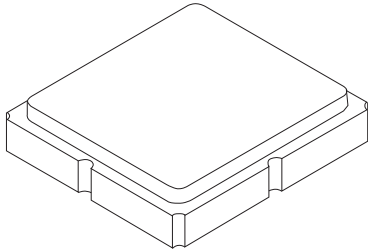

PCB Footprint Top View

Case and PCB Footprint Dimensions

| Dimension | mm | | | Inches | | |
|-----------|------|------|------|--------|-------|-------|
| | Min | Nom | Max | Min | Nom | Max |
| A | 2.87 | 3.00 | 3.13 | 0.113 | 0.118 | 0.123 |
| B | 2.87 | 3.00 | 3.13 | 0.113 | 0.118 | 0.123 |
| C | 1.12 | 1.25 | 1.38 | 0.044 | 0.049 | 0.054 |
| D | 0.77 | 0.90 | 1.03 | 0.030 | 0.035 | 0.040 |
| E | 2.67 | 2.80 | 2.93 | 0.105 | 0.110 | 0.115 |
| F | 1.47 | 1.60 | 1.73 | 0.058 | 0.063 | 0.068 |
| G | 0.72 | 0.85 | 0.98 | 0.028 | 0.033 | 0.038 |
| H | 1.37 | 1.50 | 1.63 | 0.054 | 0.059 | 0.064 |
| I | 0.47 | 0.60 | 0.73 | 0.019 | 0.024 | 0.029 |
| J | 1.17 | 1.30 | 1.43 | 0.046 | 0.051 | 0.056 |
| K | | 3.20 | | | 0.126 | |
| L | | 1.70 | | | 0.067 | |
| M | | 1.05 | | | 0.041 | |
| N | | 0.81 | | | 0.032 | |
| O | | 0.38 | | | 0.015 | |

Case Materials

| Materials | |
|--------------------|--|
| Solder Pad Plating | 0.3 to 1.0 μ m Gold over 1.27 to 8.89 μ m Nickel |
| Lid Plating | 2.0 to 3.0 μ m Nickel |
| Body | Al ₂ O ₃ Ceramic |
| Pb Free | |

Top View

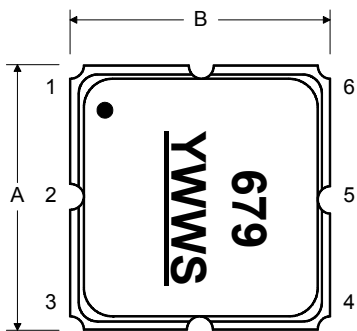

Bottom View

