

DETAILS

Product Number	C13937_STRADA-2X2-C-STP
Family	Strada
Type	Lens
Color	clear
Diameter	50 x 50 mm
Height	6,27 mm
Style	square
Optic Material	PMMA
Holder Material	
Fastening	screw, pin
Status	production ready
ROHS Compliant	Yes
Date Updated	21/04/2016



OPTICAL PROPERTIES

LED	Viewing Angle	Light Beam	Efficiency	cd/lm	Connector
XP-G2	137 deg	Streetligh...	94 %	0.300	-
XP-L	139 deg	Streetligh...	92 %	0.280	-
XP-L HI	136 deg	Streetligh...	94 %	0.300	-
XP-G3	141 deg	Streetligh...	94 %	0.290	-
XP-L2	139 deg	Streetligh...	94 %	0.290	-
H35C1 (LEMWA33)	136 deg	Streetligh...	94 %	0.310	-
LUXEON MZ	133 deg	Streetligh...	94 %	0.320	-
LUXEON 5050	133 deg	Streetligh...	94 %	0.320	-
LUXEON TX	133 deg	Streetligh...	94 %	0.320	-
NVSW3x9A	138 deg	Streetligh...	94 %	0.300	-
Oslon Square PC	130 deg	Streetligh...	94 %	0.330	-
Oslon Square Gen3	137 deg	Streetligh...	94 %	0.320	-
Duris S8	sim: 120	Streetligh...	sim: 93 %	sim: 0.350	-
Fortimo FastFlex LED board 2x8 DA G4	136 deg	Streetligh...	94 %	0.300	-
LH351Z	127 deg	Streetligh...	94 %	0.320	-
LH351B	134 deg	Streetligh...	94 %	0.310	-
LH351D	sim: 123	Streetligh...	sim: 91 %	sim: 0.310	-
LH508A	Asymmetric deg	Streetligh...	94 %	0.320	-
TL1L4	119 deg	Streetligh...	92 %	0.340	-
RLE G1 49x223mm 4000lm xxx EXC OT	29 deg	Streetligh...	94 %	0.330	-
RLE G1 49x245mm 4000lm xxx EXC OT	29 deg	Streetligh...	94 %	0.330	-
RLE G1 49x121mm 2000lm xxx EXC OT	29 deg	Streetligh...	94 %	0.330	-
RLE G1 49x133mm 2000lm xxx EXC OT	29 deg	Streetligh...	94 %	0.330	-

H G F E D C B A

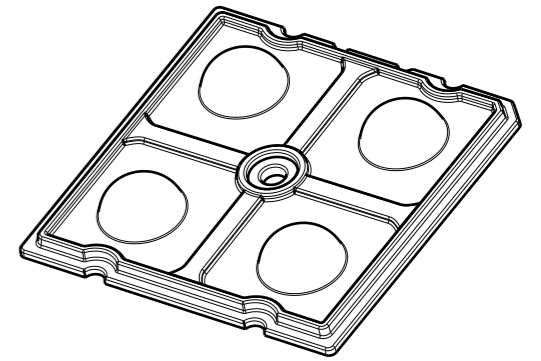
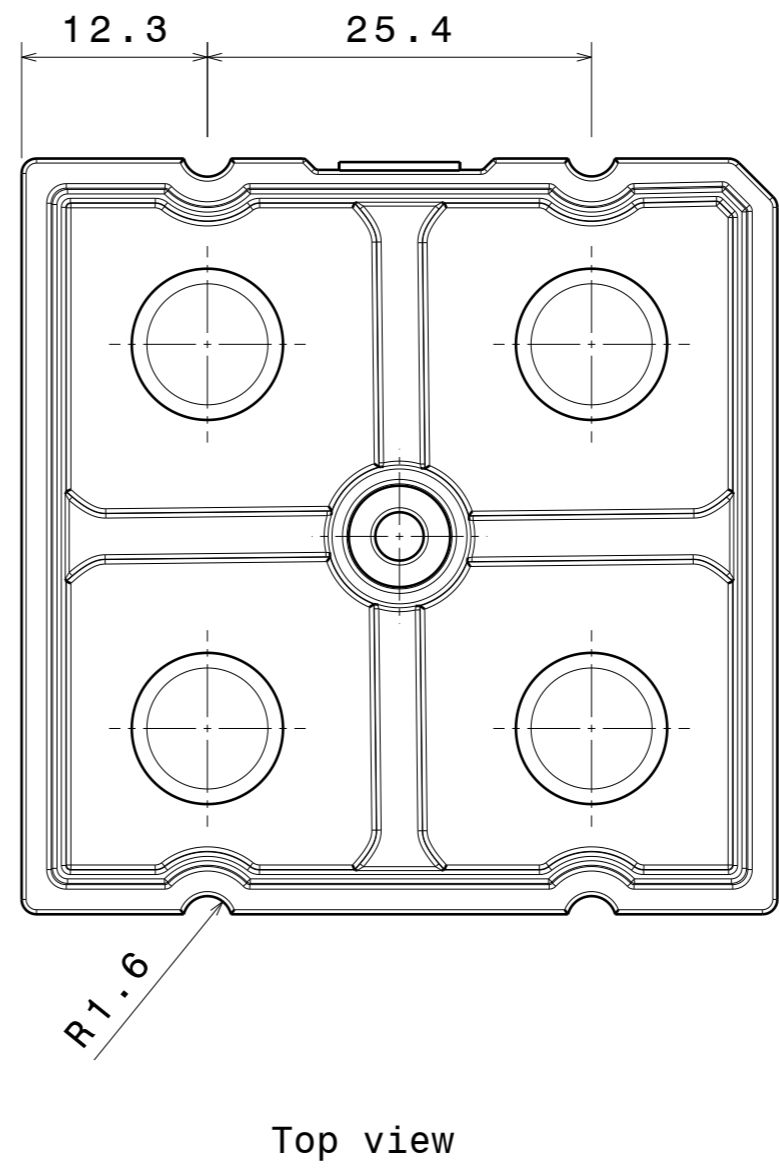
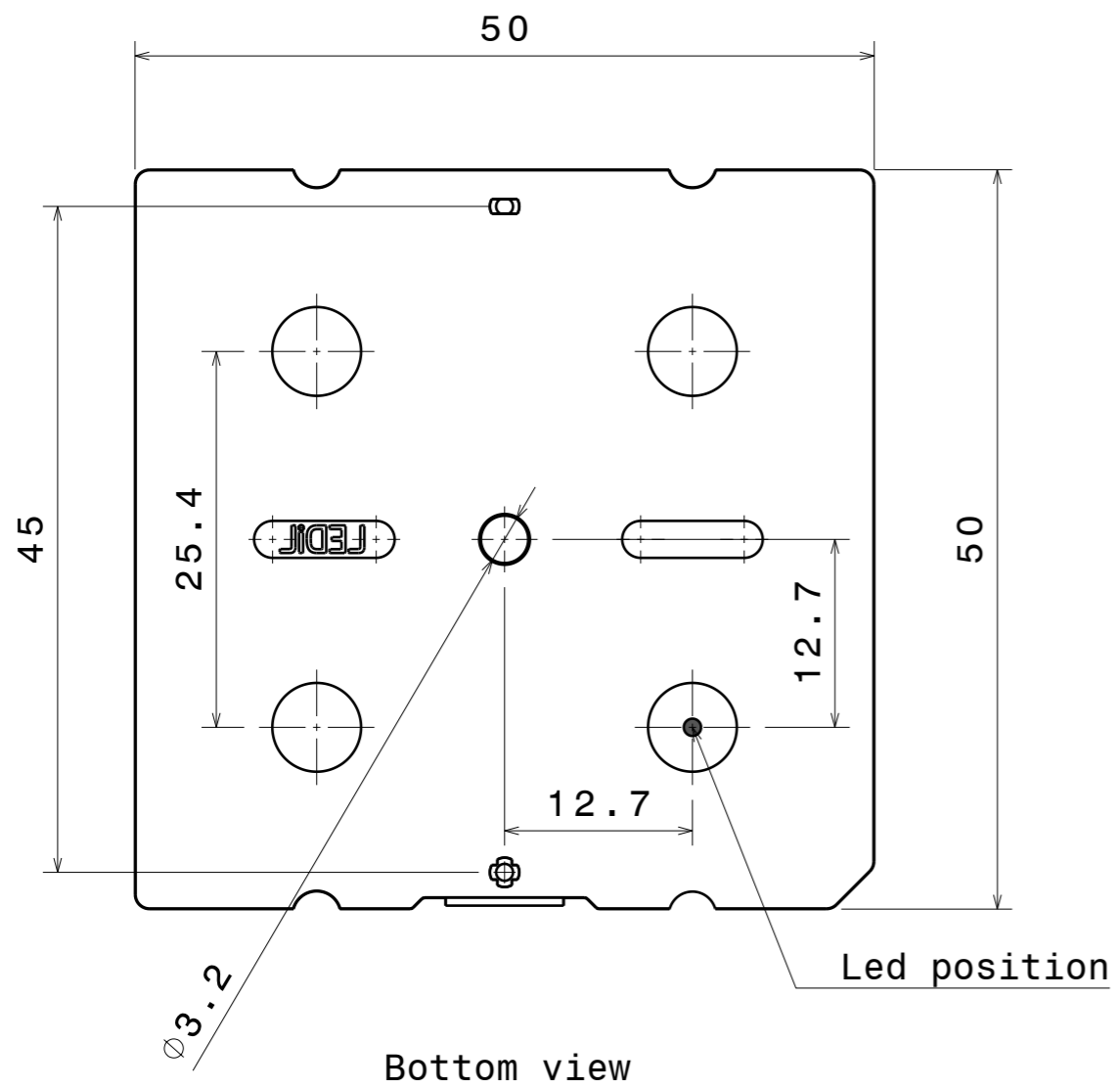

Isometric view
Scale 1:1

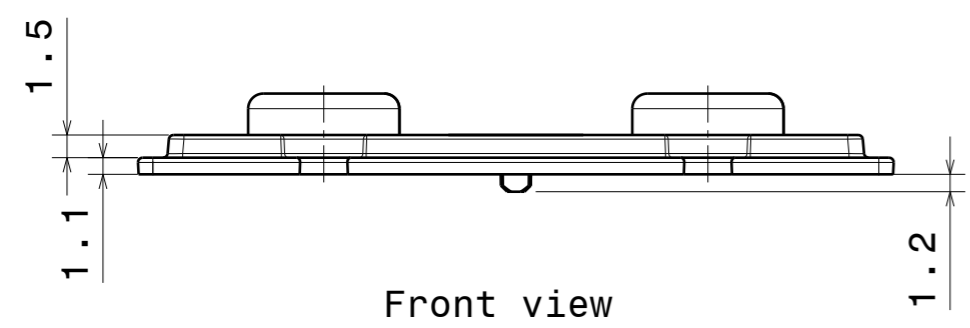
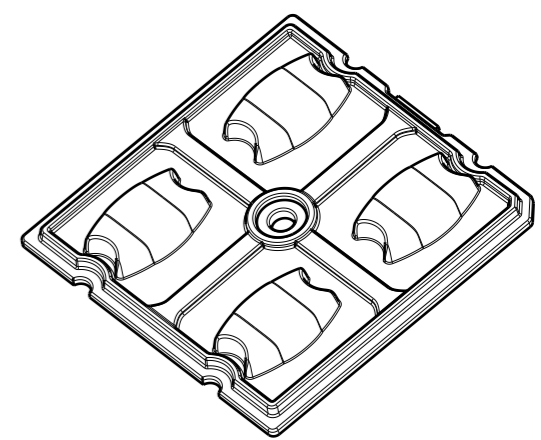

This drawing applies to:
C13936_STRADA-2X2-B2-STP
C13937_STRADA-2X2-C-STP

Tolerances if not otherwise shown
According to DIN ISO 2768-1
Linear measures:
Up to 30mm class M, otherwise class C.
According to DIN ISO 2768-2
Form and position: class L

LEDiL Ledil Oy
Salorankatu 10
FIN 24240 SALO
Finland

THIRD ANGLE PROJECTION:

DRAWING TITLE
Datasheet_STRADA-2X2-STP

This drawing is the property of LEDiL Oy. It may not be reproduced, copied or communicated without a written agreement with LEDiL Oy."

SIZE	PART NUMBER		
A3	-		

SCALE	2:1	WEIGHT	(g)	SHEET	1/1
-------	-----	--------	-----	-------	-----

H G F E D C B A

Luminaire: LEDiL Oy C13937_STRADA-2X2-C-STP_(XP-G2)

Lamps: 1 x Cree_XP-G2_(XPG-BWT-L1-000-00-G51)_411.002lm@250mA_P=2.95164W_I=0.250A

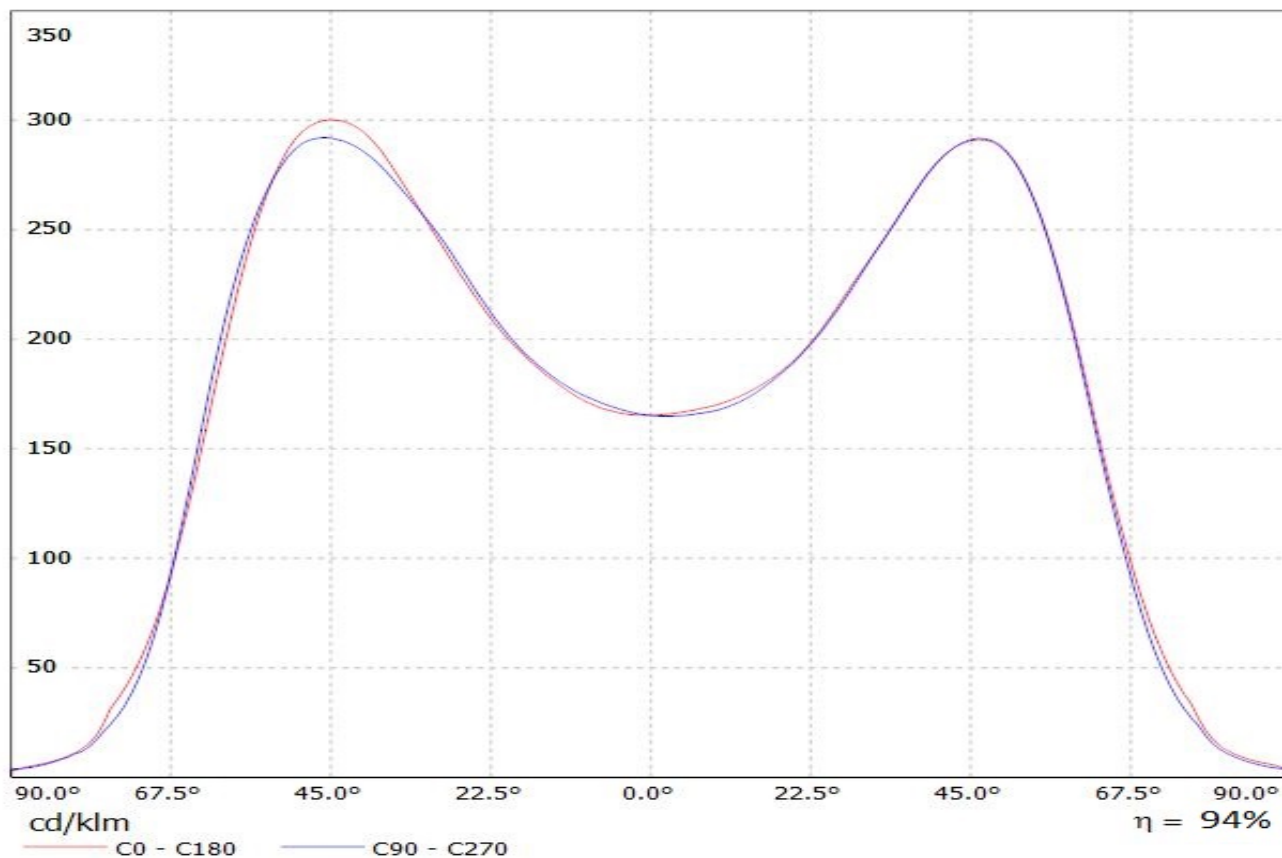

Luminaire: LEDiL Oy C13937_STRADA-2x2-C-STP_(XP-L)
Lamps: 1 x CREE_XP-L_2x2_(XPLAWT-0-1B0-V40-00-0001)_504.373lm@250mA_CCT=7600K_P=2.79963W_I=249.9mA

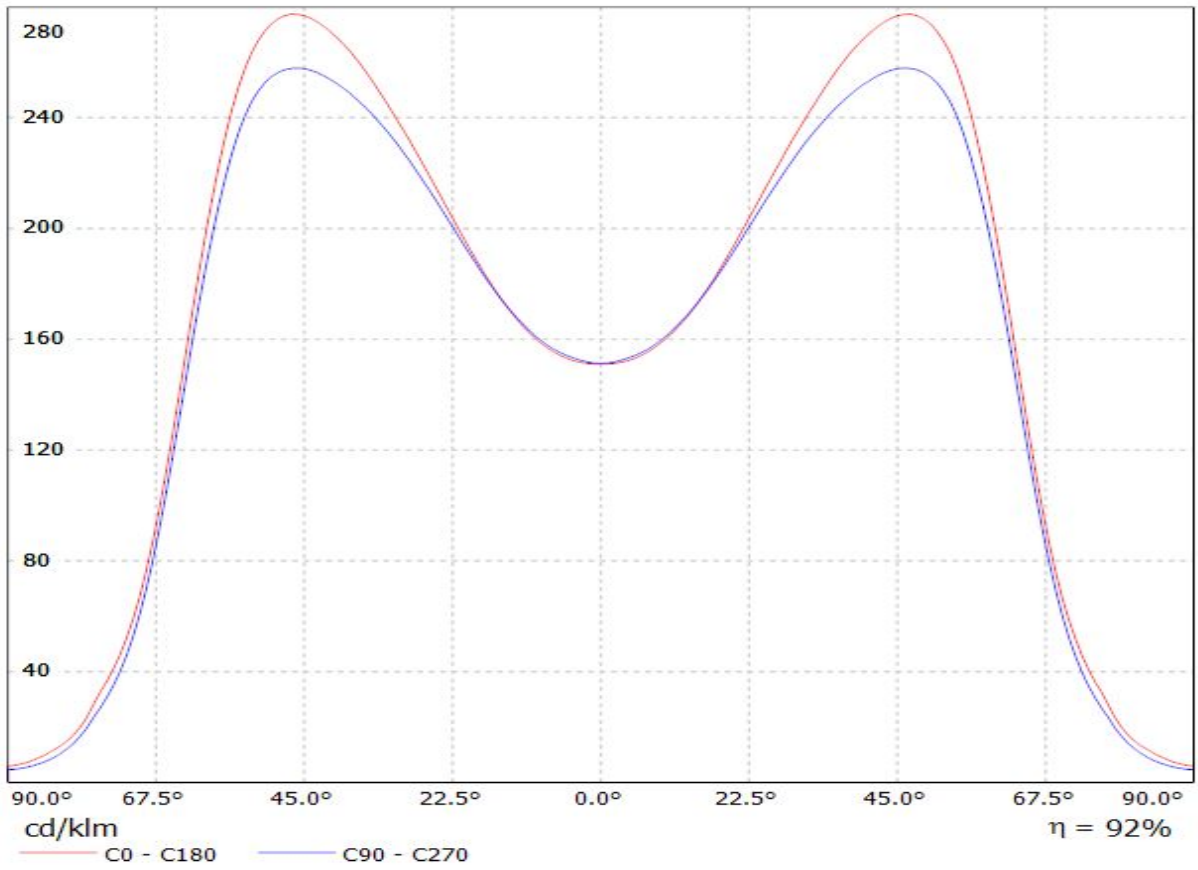

Luminaire: LEDiL Oy C13937_STRADA-2X2-C-STP_(XP-L_HI)
Lamps: 1 x Cree_XP-L_HI_(2x2)_(XPLAWT-H-5A3-U60-013-0001)
_455.077lm@250mA_P=2.84011W_I=0,2499A

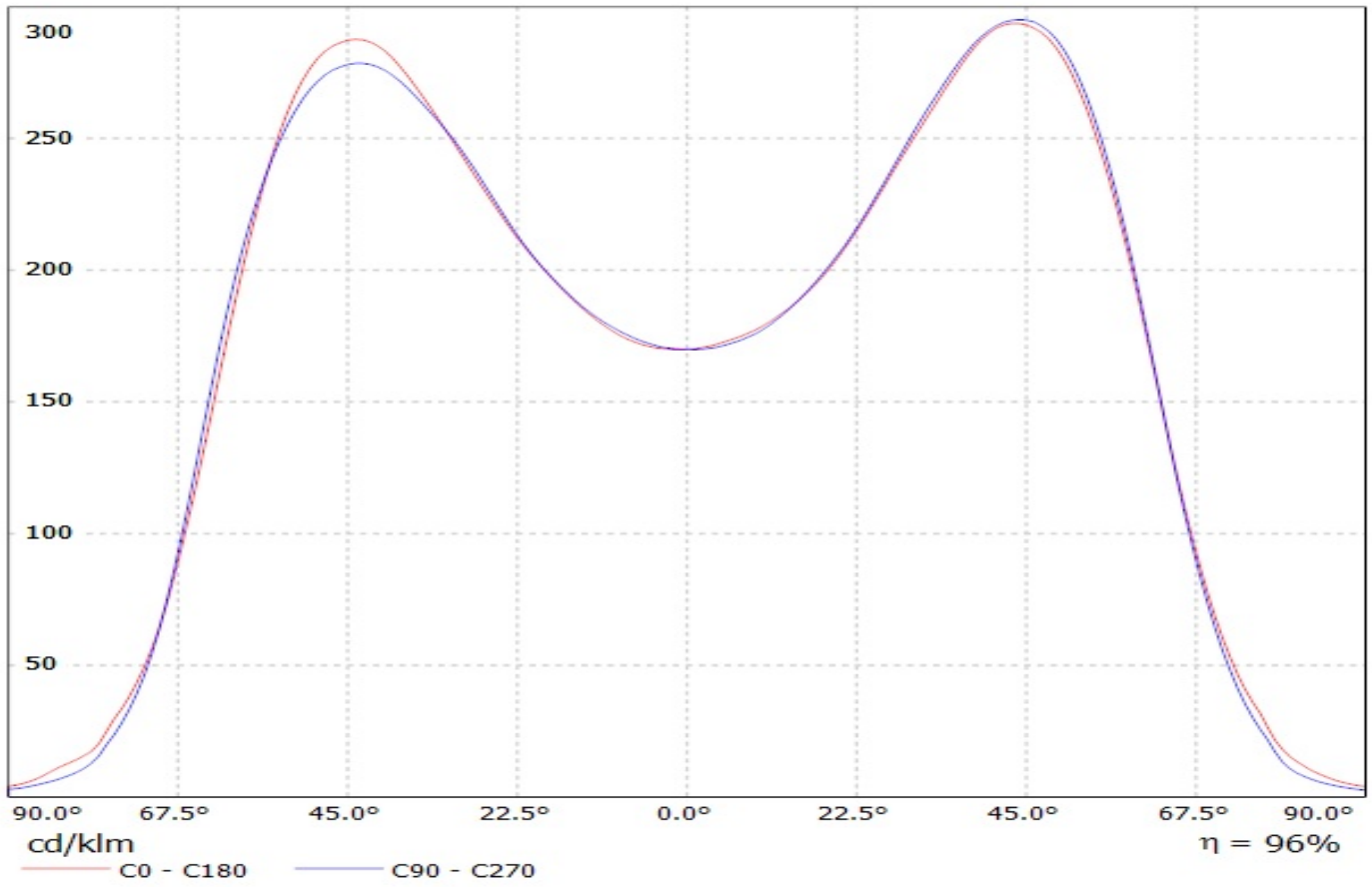

Luminaire: Ledil C13937_STRADA-2X2-C-STP_(XP-G3)

Lamps: 1 x Cree_XP-G3_2x2_(XPGDWT-B1-3C0-S4-0-01)_516.212lm@250mA_P=2.78875W_I=0.250A

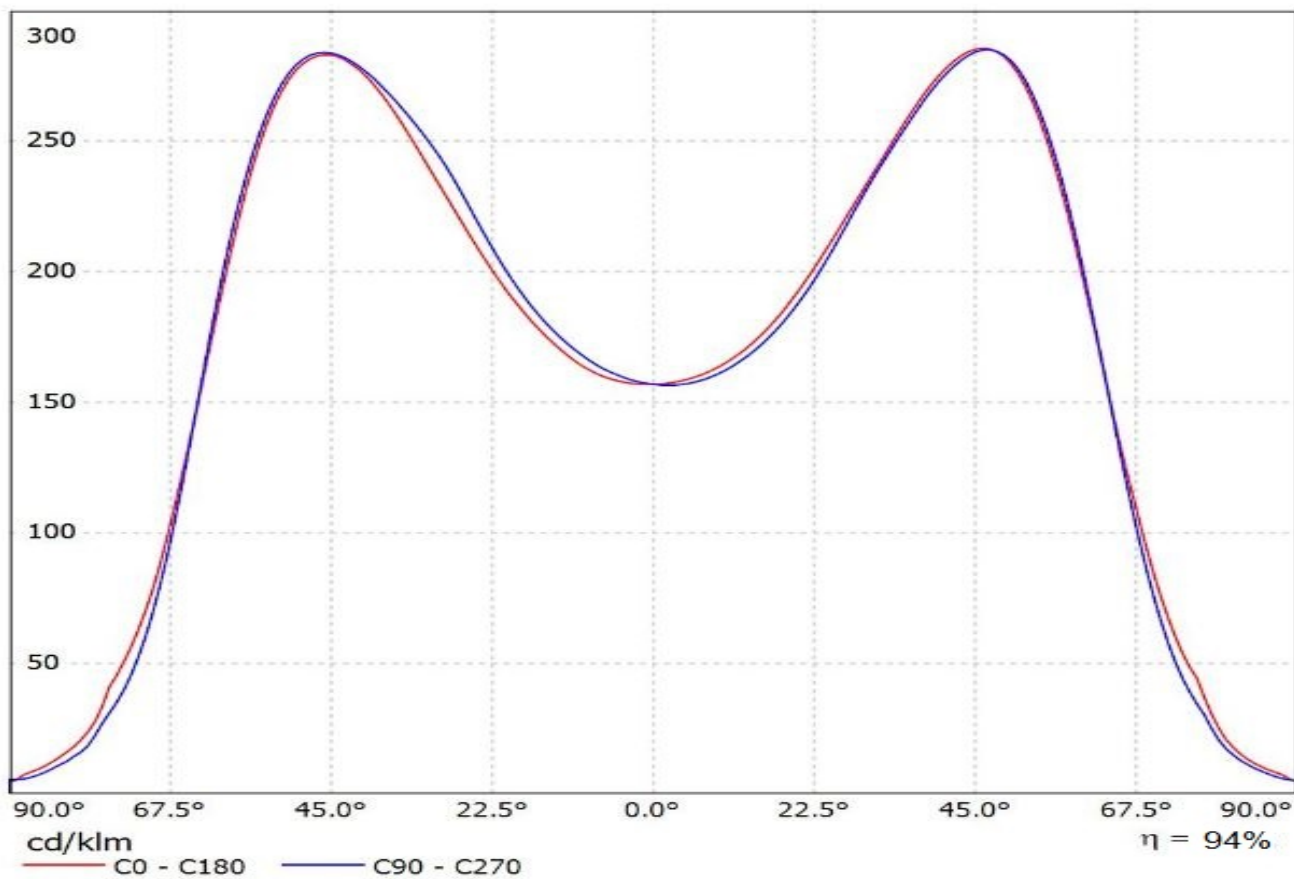

Luminaire: Ledil C13937_STRADA-2X2-C-STP_(XP-L2)

Lamps: 1 x Cree_XP-L2_2x2_(XPLBWT-00-0000-000BV50E3)550.93lm@250mA_P=2.7815W_I=0.25A

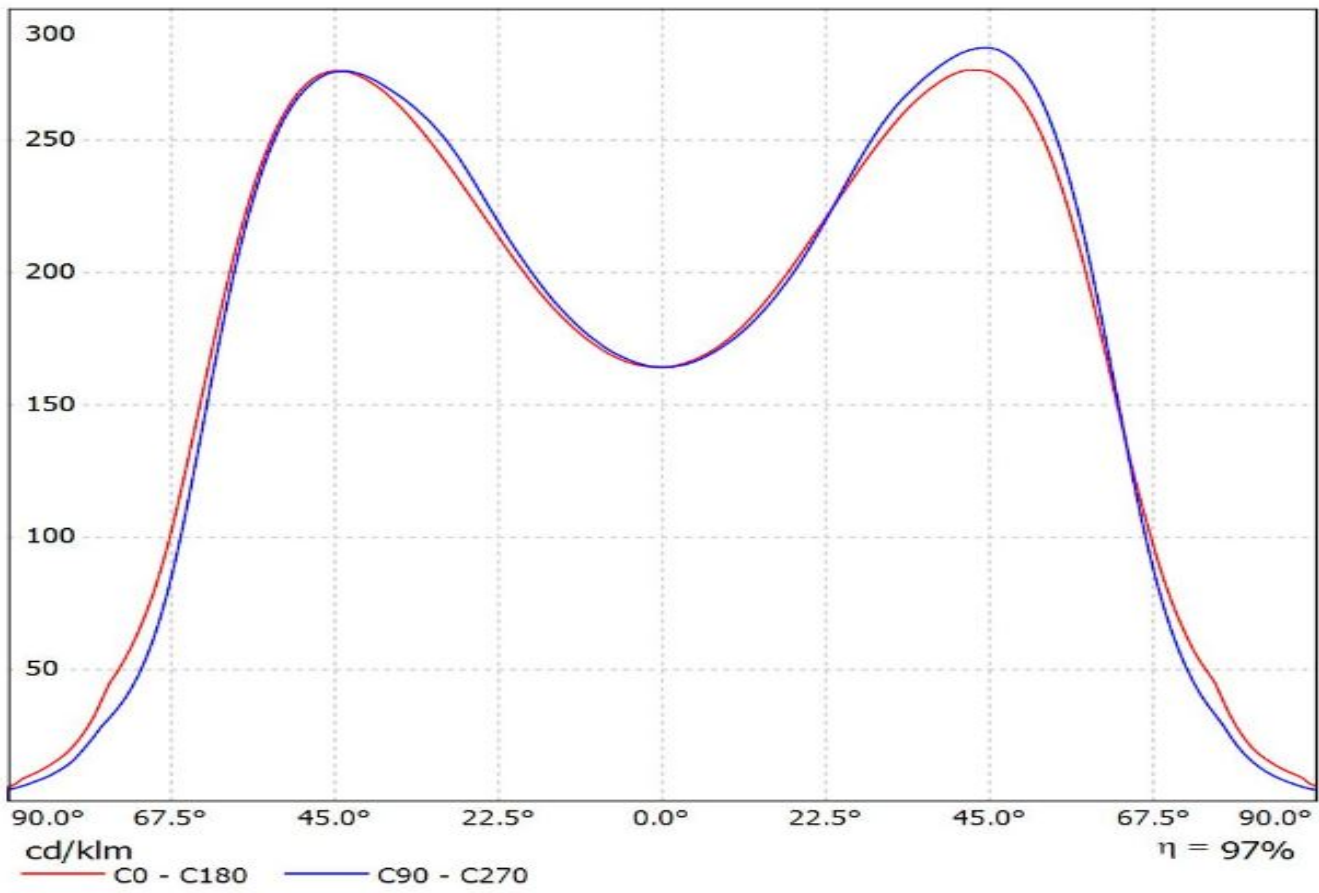

Luminaire: Ledil C13937_STRADA_2x2-C-STP_(H35C1)
Lamps: 1 x LG_H35C1_2x2_477.216lm@250mA_P=2.87475W_I=0.250A

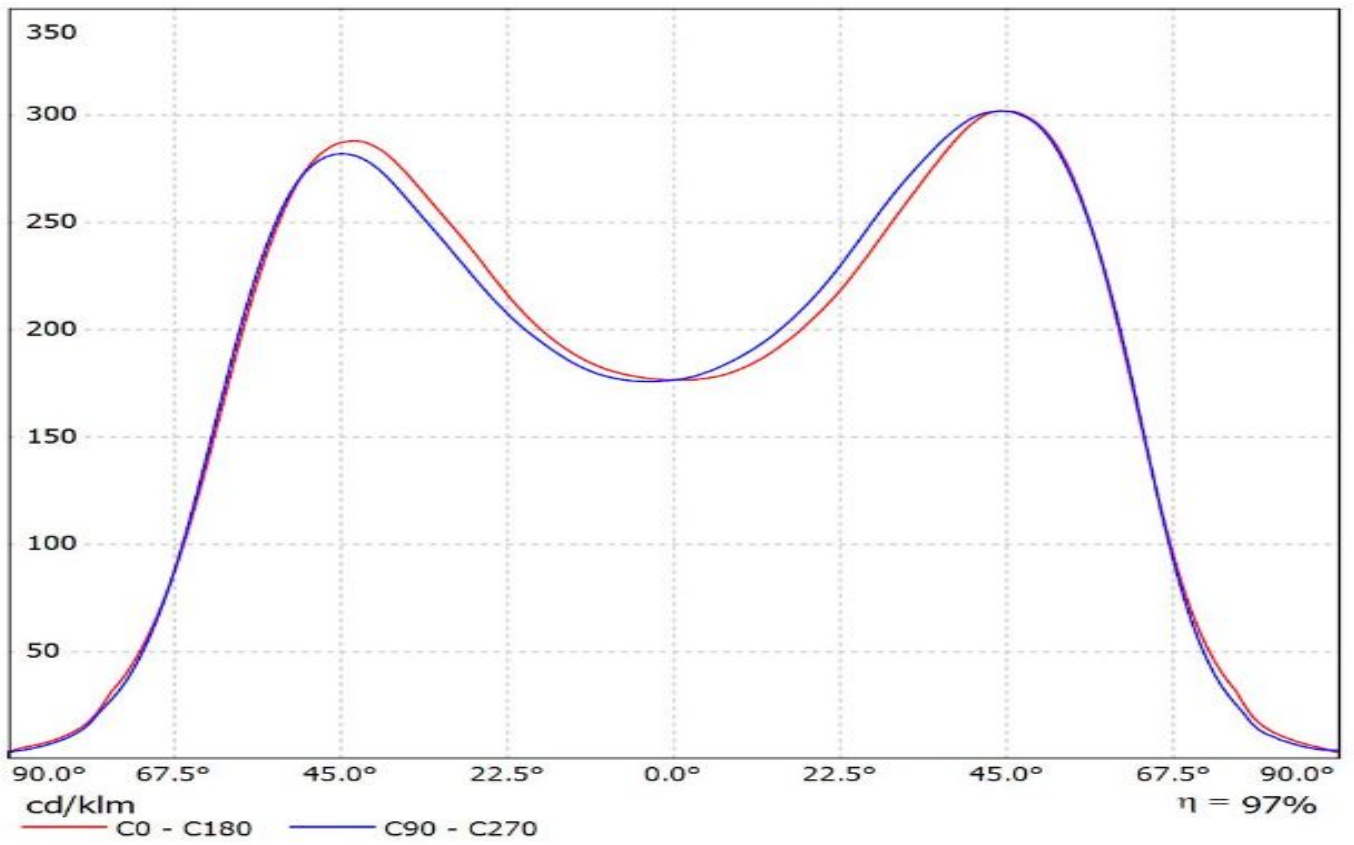

Luminaire: Ledil C13937_STRADA-2X2-C-STP_(Luxeon_MZ)

Lamps: 1 x Philips_Lumileds_Luxeon_MZ_(LMZ7-QW57)_(2x2)_427.268lm@250mA_P=2.734W_η=0.2500A

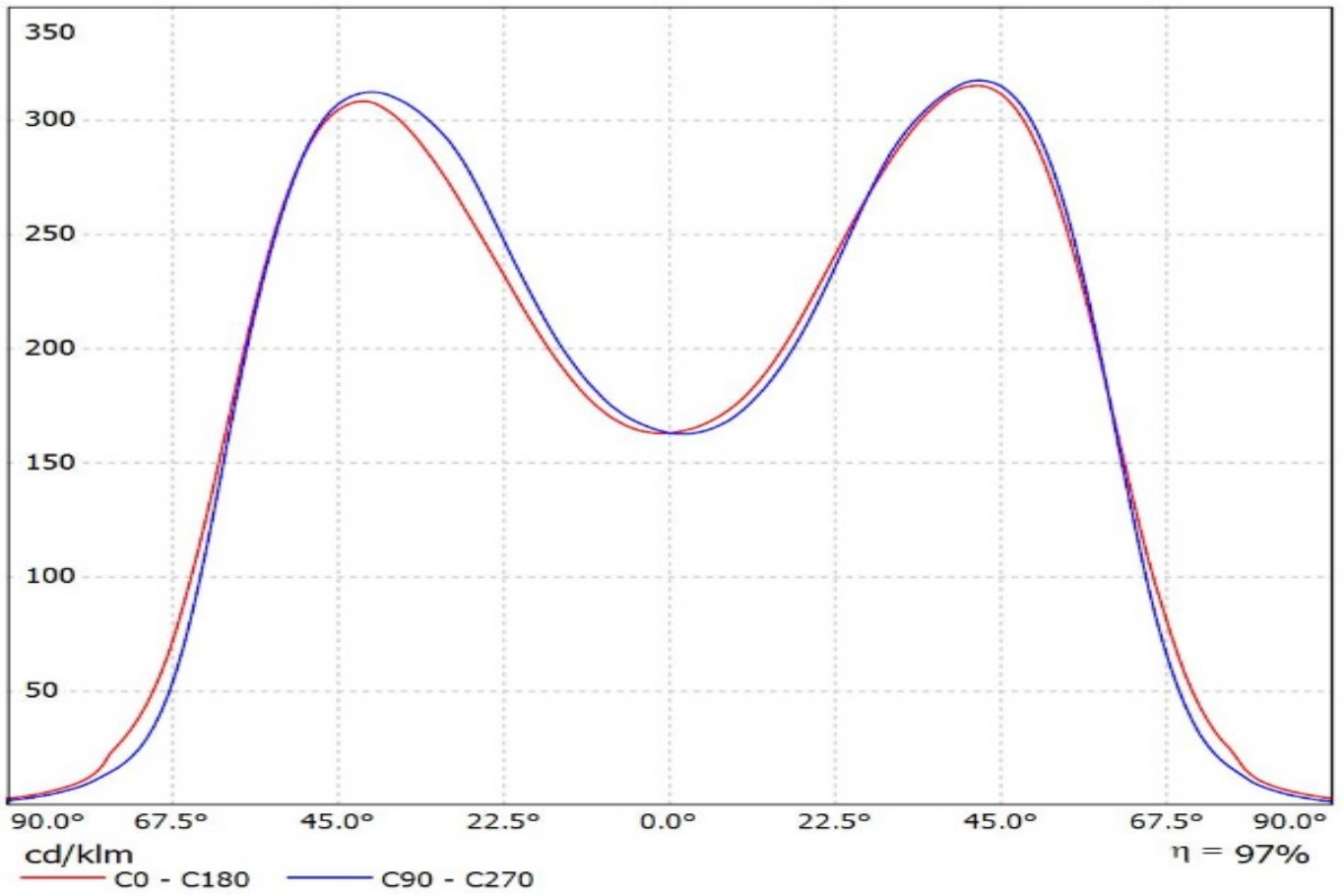

Luminaire: LEDiL Oy C13937_STRADA-2X2-C-STP_(Luxeon_5050)
Lamps: 1 x Luxeon_5050_2x2_1270.76lm@80mA_CCT=5700K_P=7.35815W_I=0.080A_70CRI

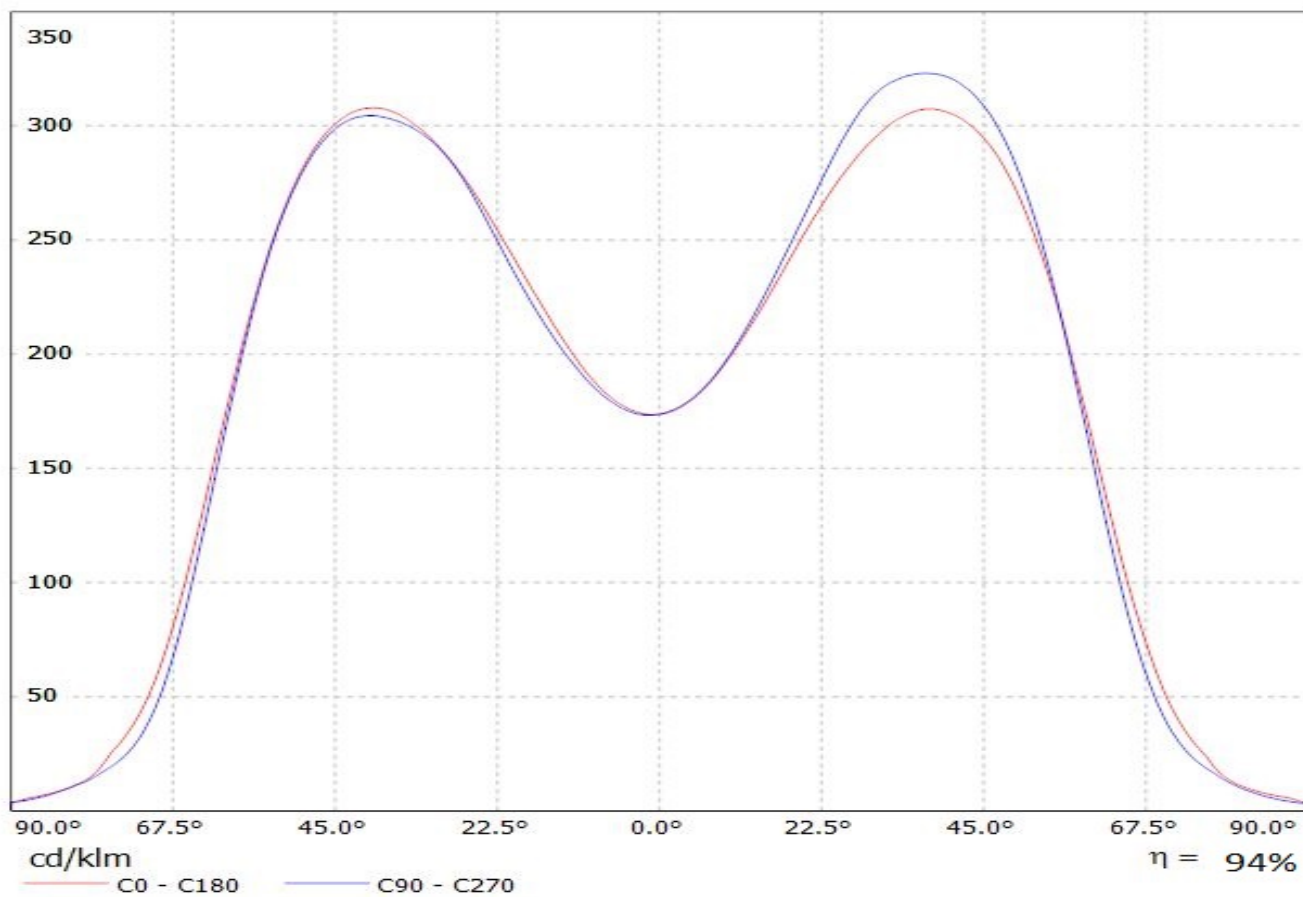

Luminaire: LEDiL Oy C13937_STRADA-2X2-C-STP_(Luxeon_TX)
Lamps: 1 x Luxeon_TX_(L1T2-3585)_318.556lm@250mA_P=2.78827W_I=0.250A

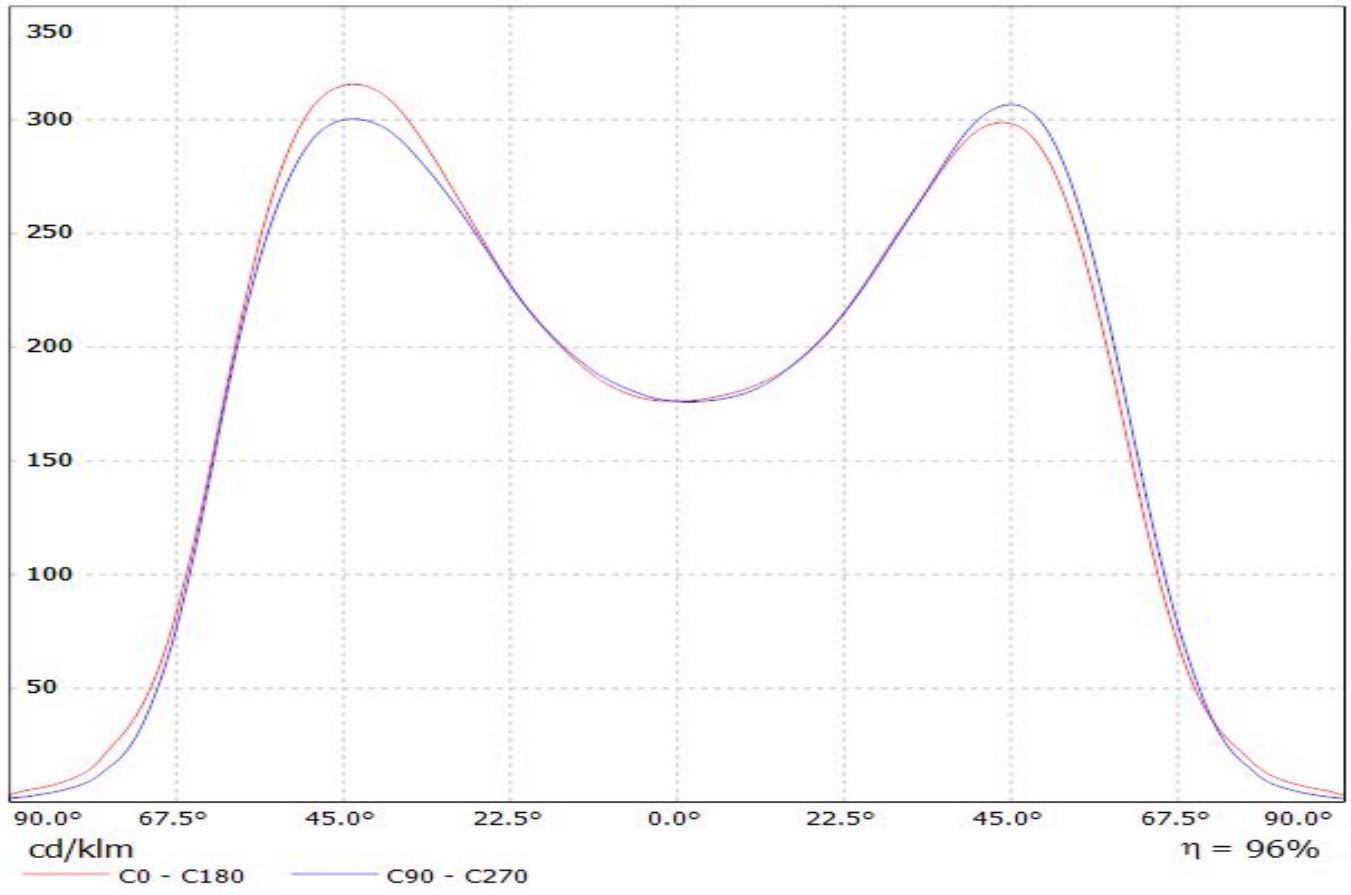

Luminaire: LEDiL Oy C13937_STRADA-2X2-C-STP_(NVSW319AE)
Lamps: 1 x Nichia_NVSW319AE_499.093lm@250mA_P=2.79052W_I=0.25A

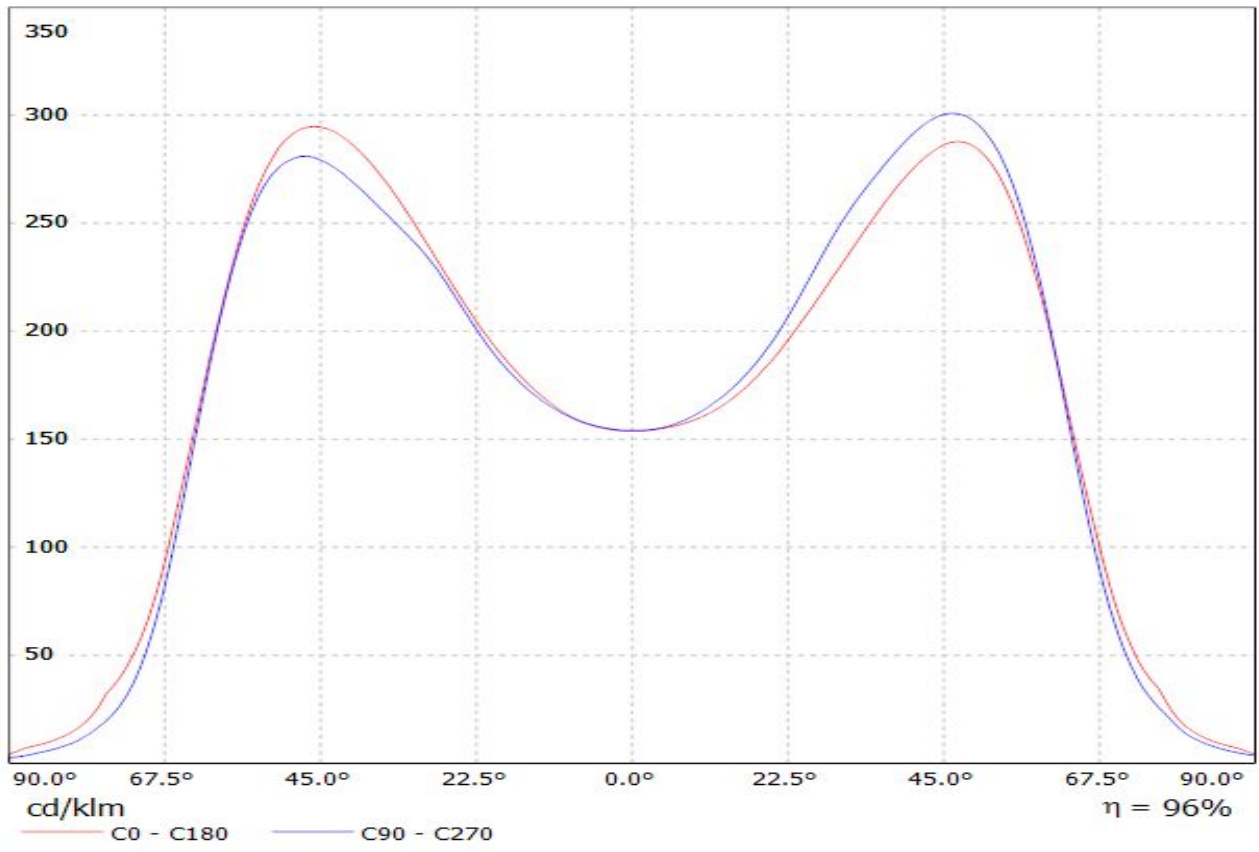

Luminaire: LEDiL Oy C13937_STRADA-2X2-C-STP_(Oslon_Square_PC_2x2)
Lamps: 1 x Osram_Oslon_Square_PC_2x2_(GWCSSRM1.PC)
_411.322lm@250mA_P=2.85186W_I=0.2499A

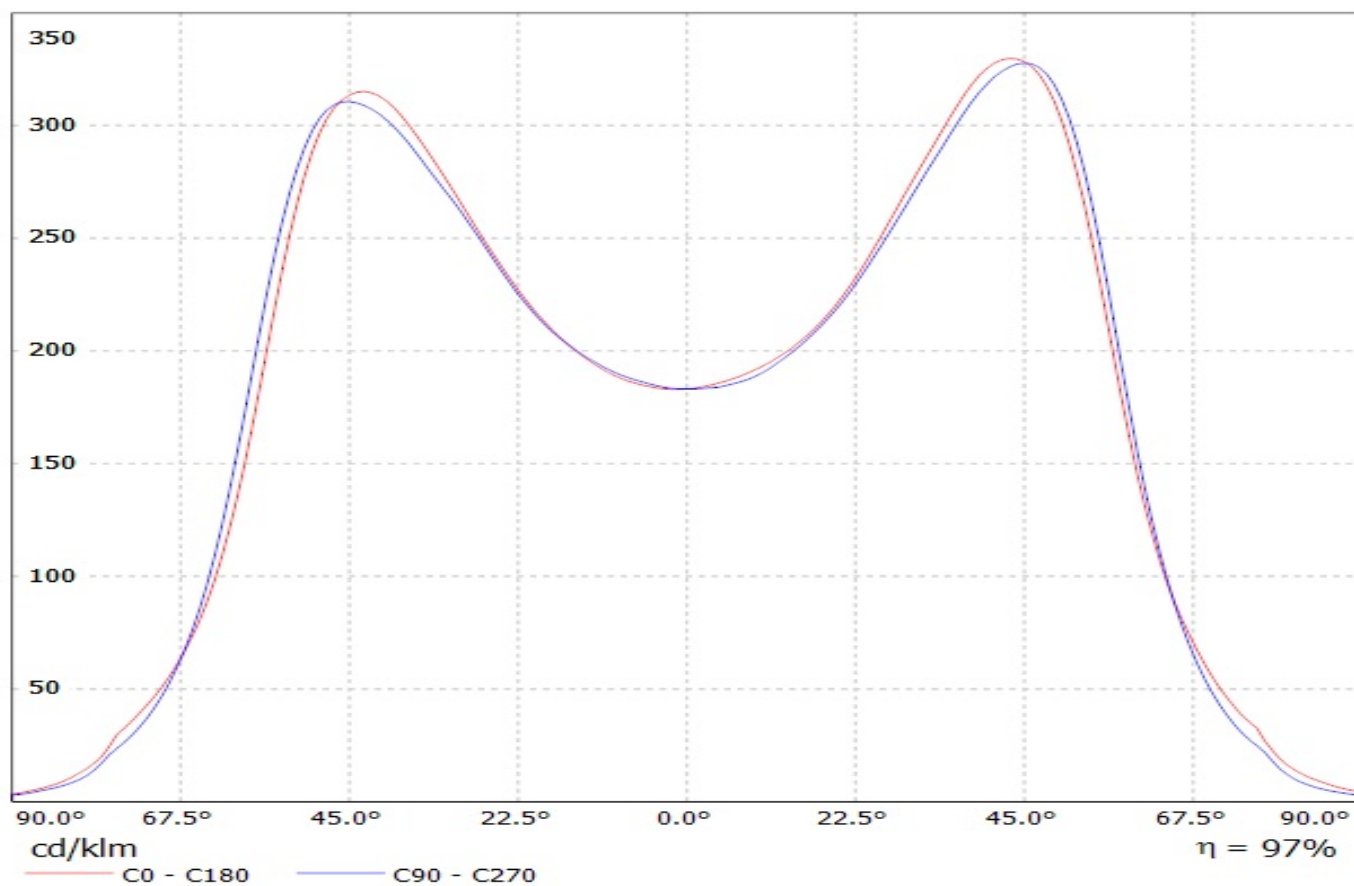

Luminaire: Ledil C13937_STRADA-2X2-C-STP_(Square_Gen3)

Lamps: 1 x Osram_Square_Gen3_(GW_CSSRM2.PM)_461.082lm@250mA_P=2.79075W_I=0.250A

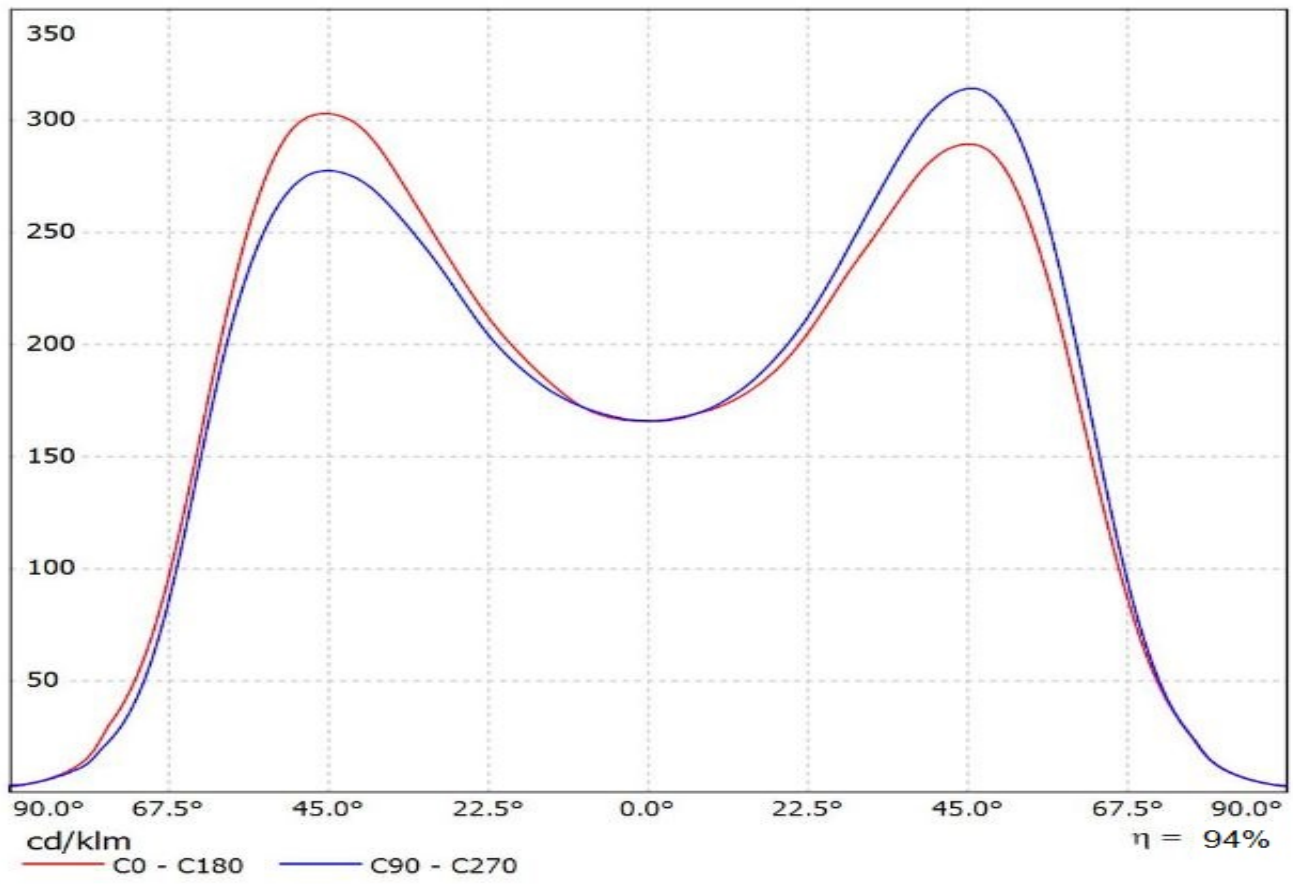

Luminaire: Ledil Oy C13937STRADA-2X2-C-STP_(Duris_S8_Gen2)_SIMULATED
Lamps: 1 x OSRAM_DURIS S8 GEN2 5050 package

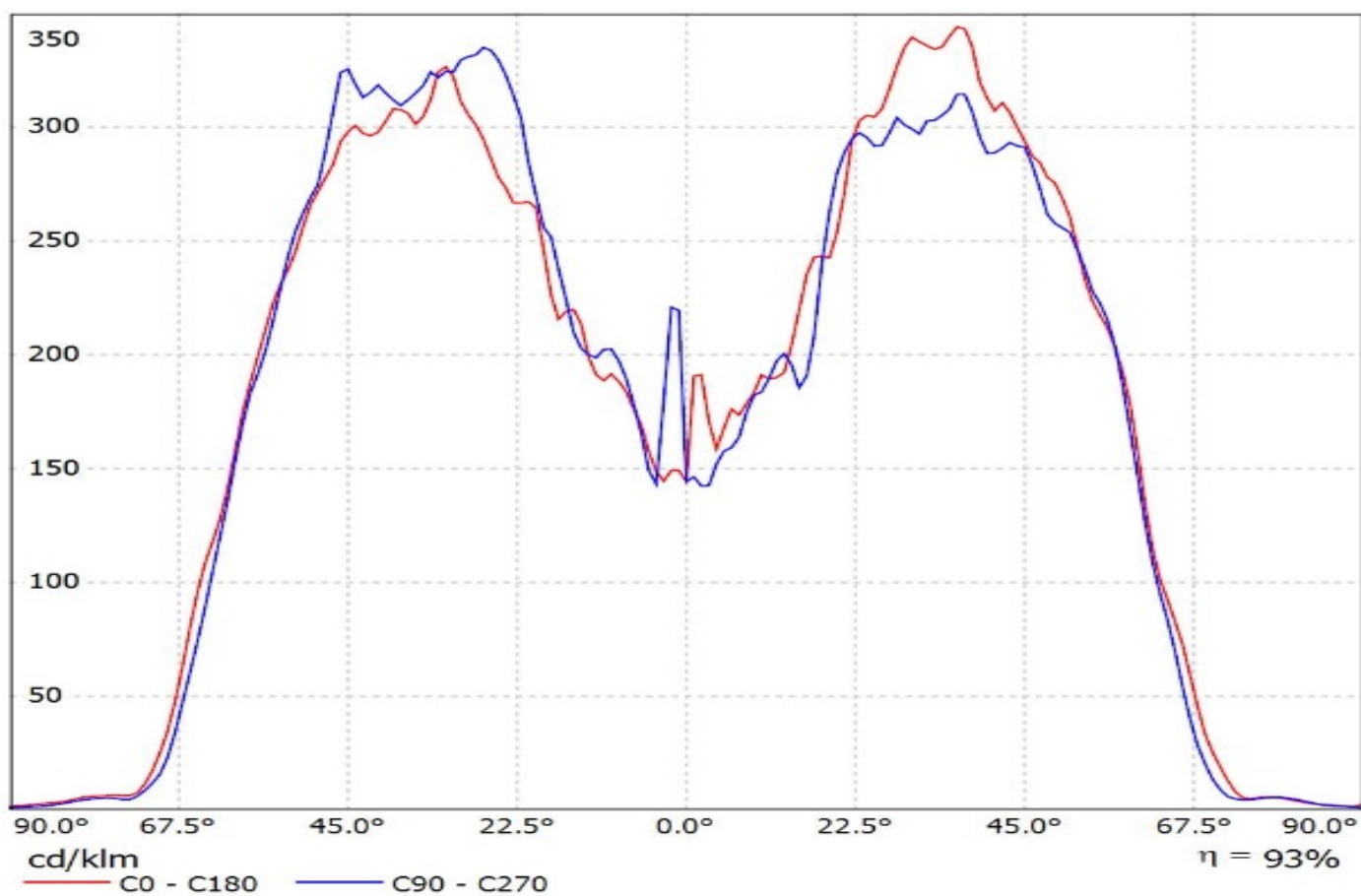

Luminaire: LEDiL Oy C13937_STRADA-2X2-C-STP_(Fortimo_F-Flex_2x8_740DAG3)
Lamps: 1 x Philips_Fortimo_F-Flex_2x8_740DAG3_1780.2lm@250mA_P=11.6112W_I=0.2498A

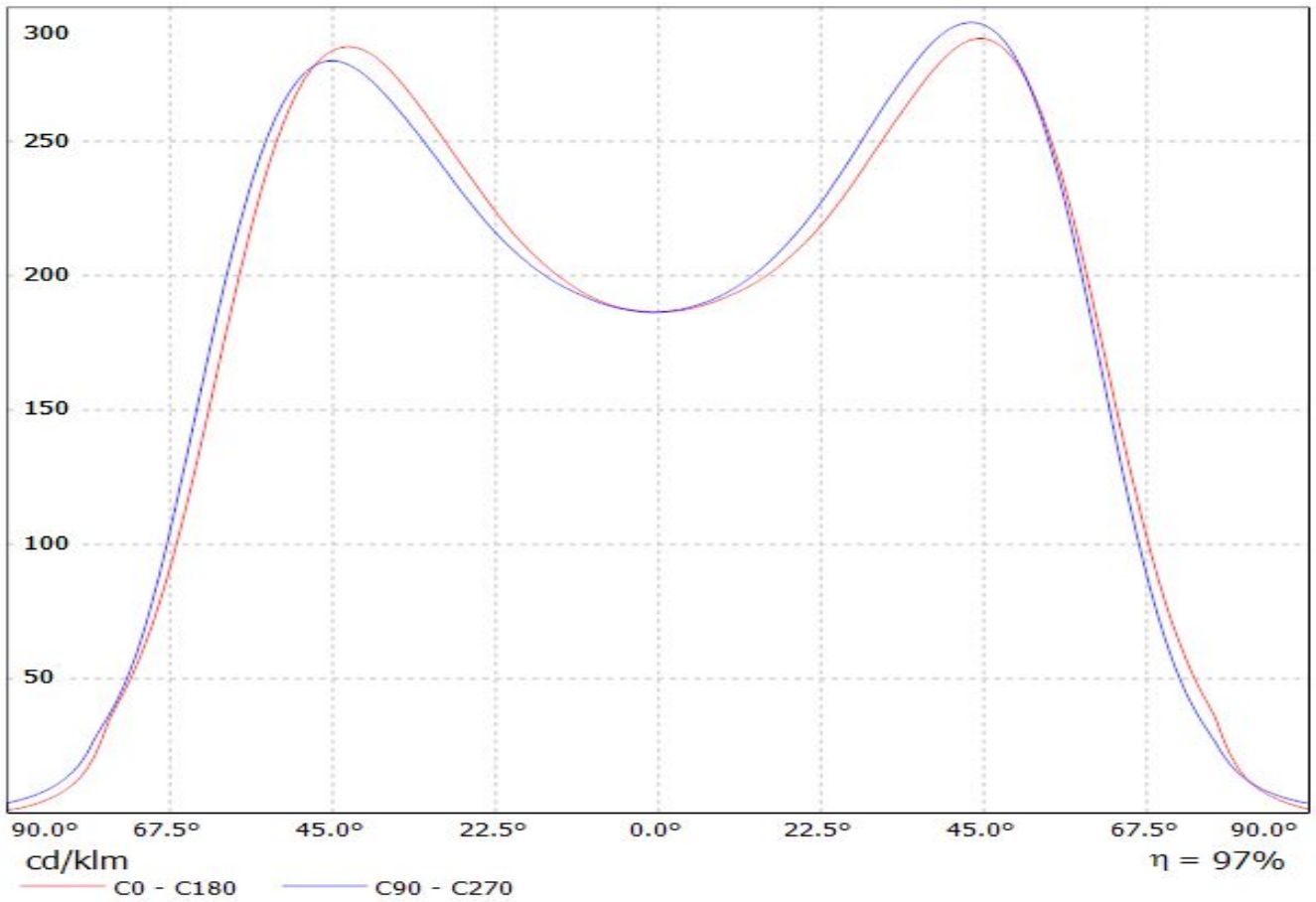

Luminaire: LEDiL Oy C13937_STRADA-2X2-C-STP_(LH351Z)

Lamps: 1 x SAMSUNG_LH351Z_2x2_369.77lm@250mA_P=2.86371W_I=249.8mA

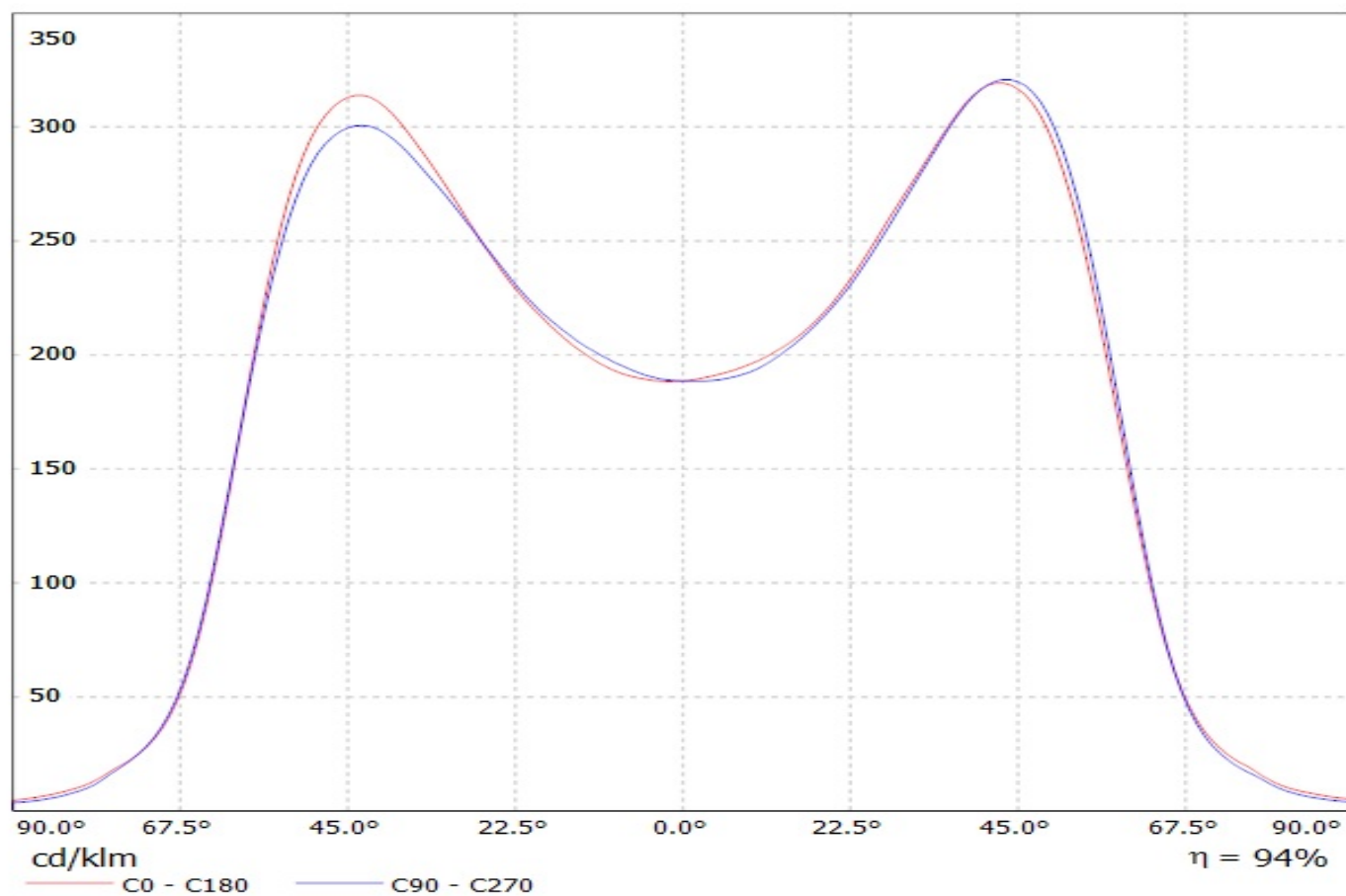

Luminaire: Ledil C13937_STRADA-2X2-C-STP_(LH351B)

Lamps: 1 x Samsung_LH351B_2x2_444:178lm@250mA_P=2.8535W_I=0.25A

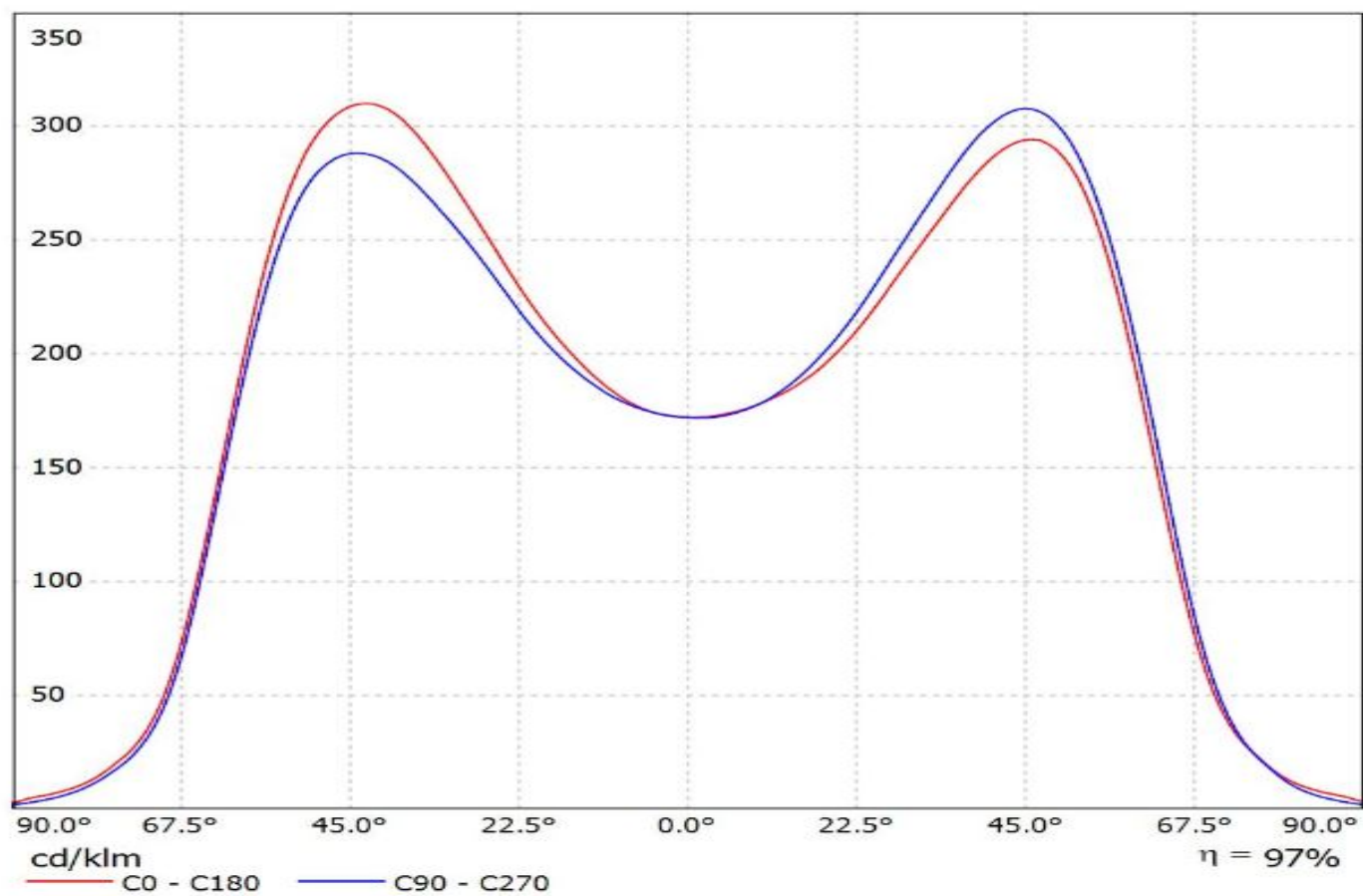

Luminaire: Ledil C13937_STRADA-2X2-C-STP_(LH508A)

Lamps: 1 x Samsung_LH508A_2x2_2060.04lm@160mA_CCT=5000K_CRI=80_P=15.5405W_I=0.16A

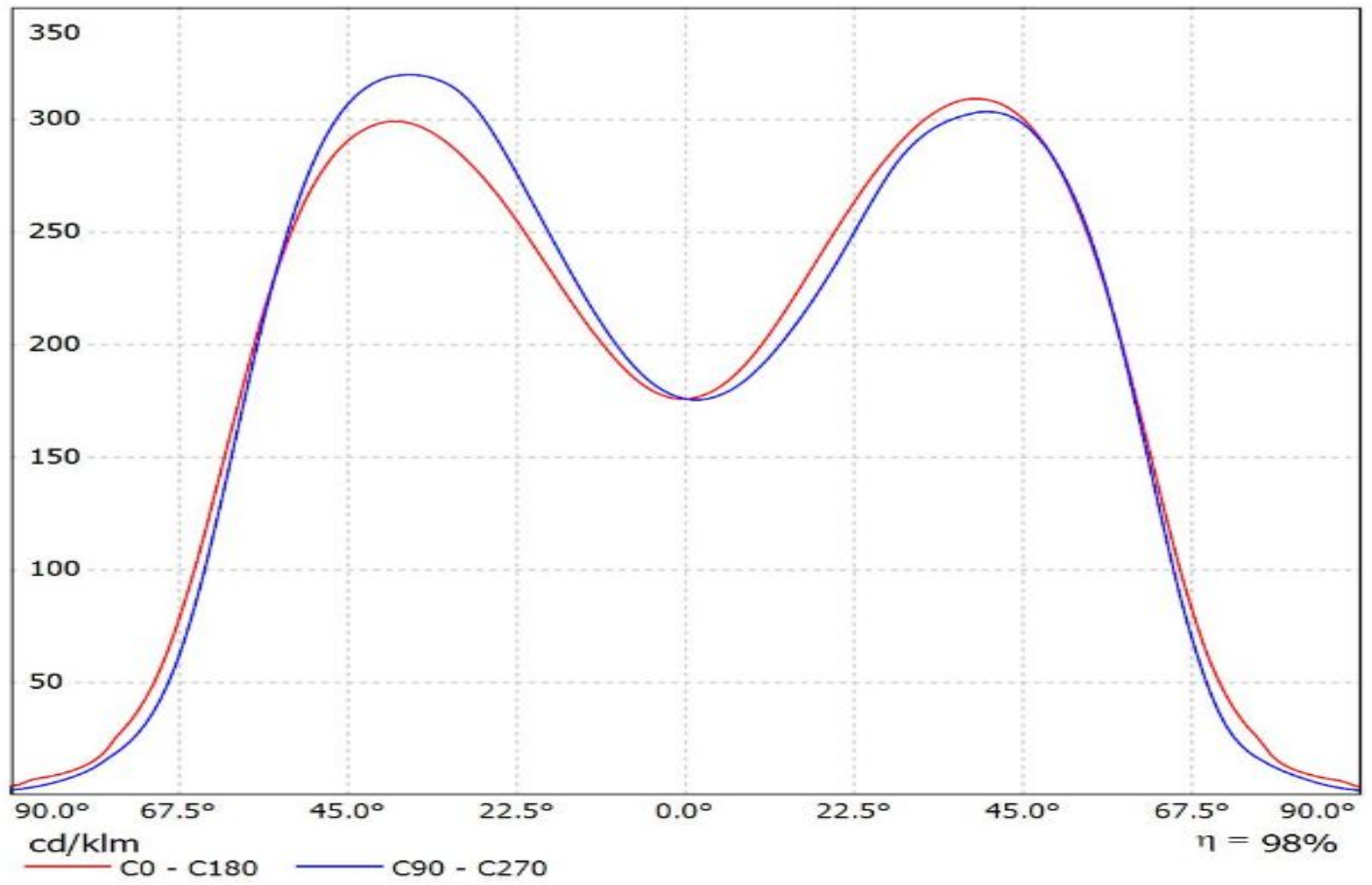

Ledil C13937_STRADA-2X2-C-STP_(TL1L4) / LDC (Linear)

Luminaire: Ledil C13937_STRADA-2X2-C-STP_(TL1L4)

Lamps: 1 x Toshiba_TL1L4_2x2_(TL1L4-DW0)_472.639lm@250mA_CCT=6500K_P=2.9W_I=0.25A

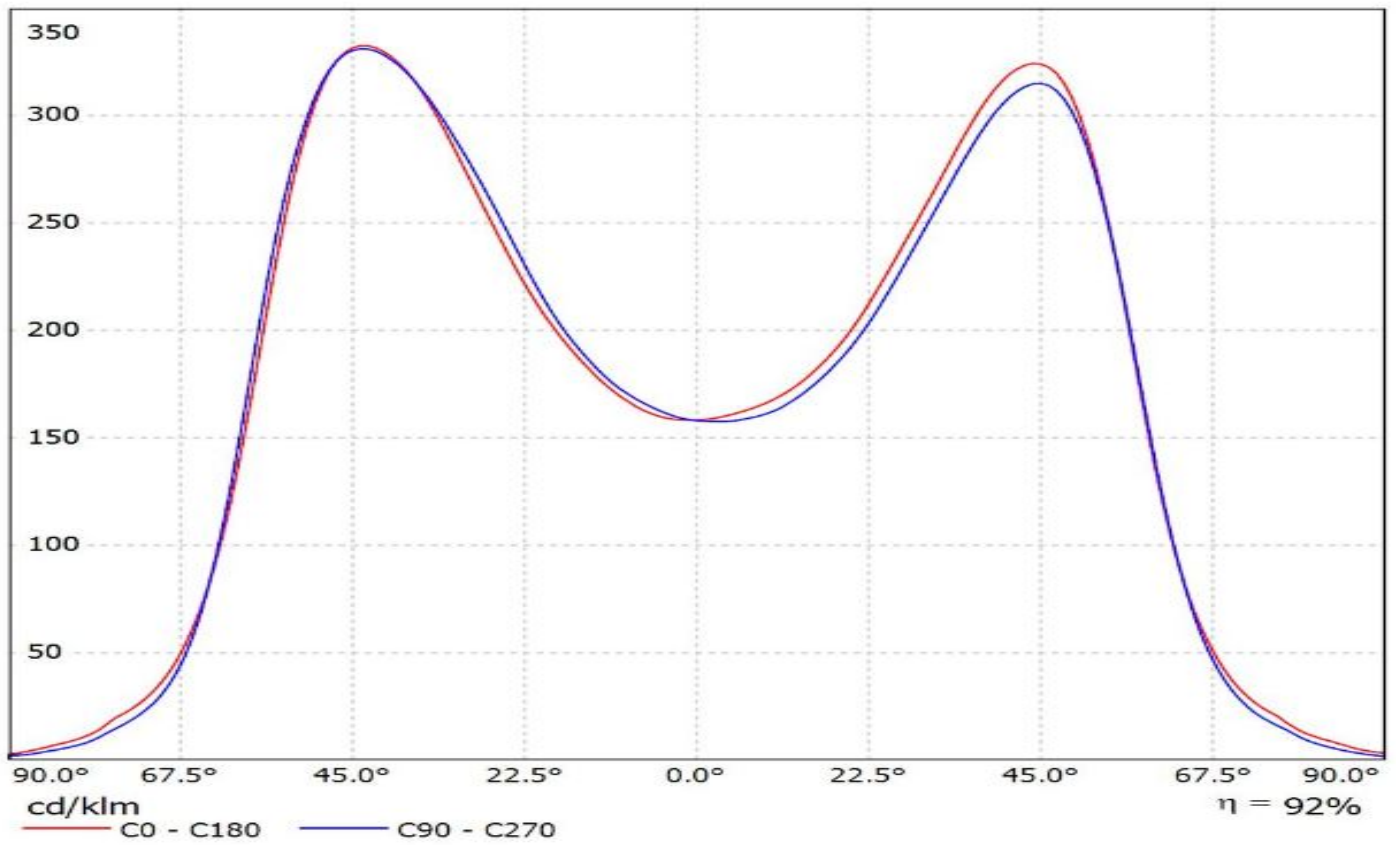

Luminaire: LEDiL Oy C13937_STRADA-2X2-C-STP_(Tridonic_Module_RLE_G1)
Lamps: 1 x Tridonic_Module_RLE_G1_4576.03lm@700mA_P=32.0681W_I=0.700A

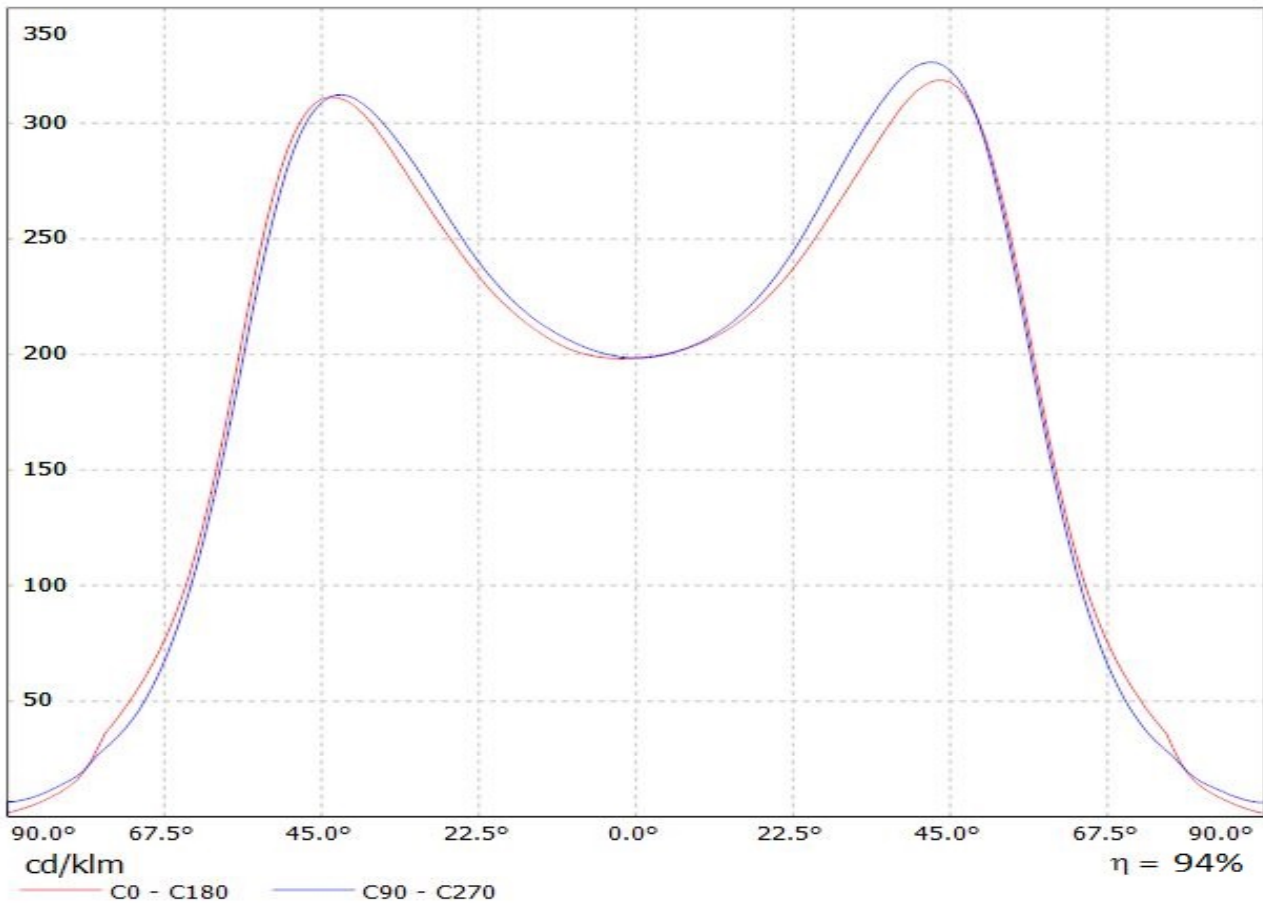

Luminaire: LEDiL Oy C13937_STRADA-2X2-C-STP_(Tridonic_Module_RLE_G1)
Lamps: 1 x Tridonic_Module_RLE_G1_4576.03lm@700mA_P=32.0681W_I=0.700A

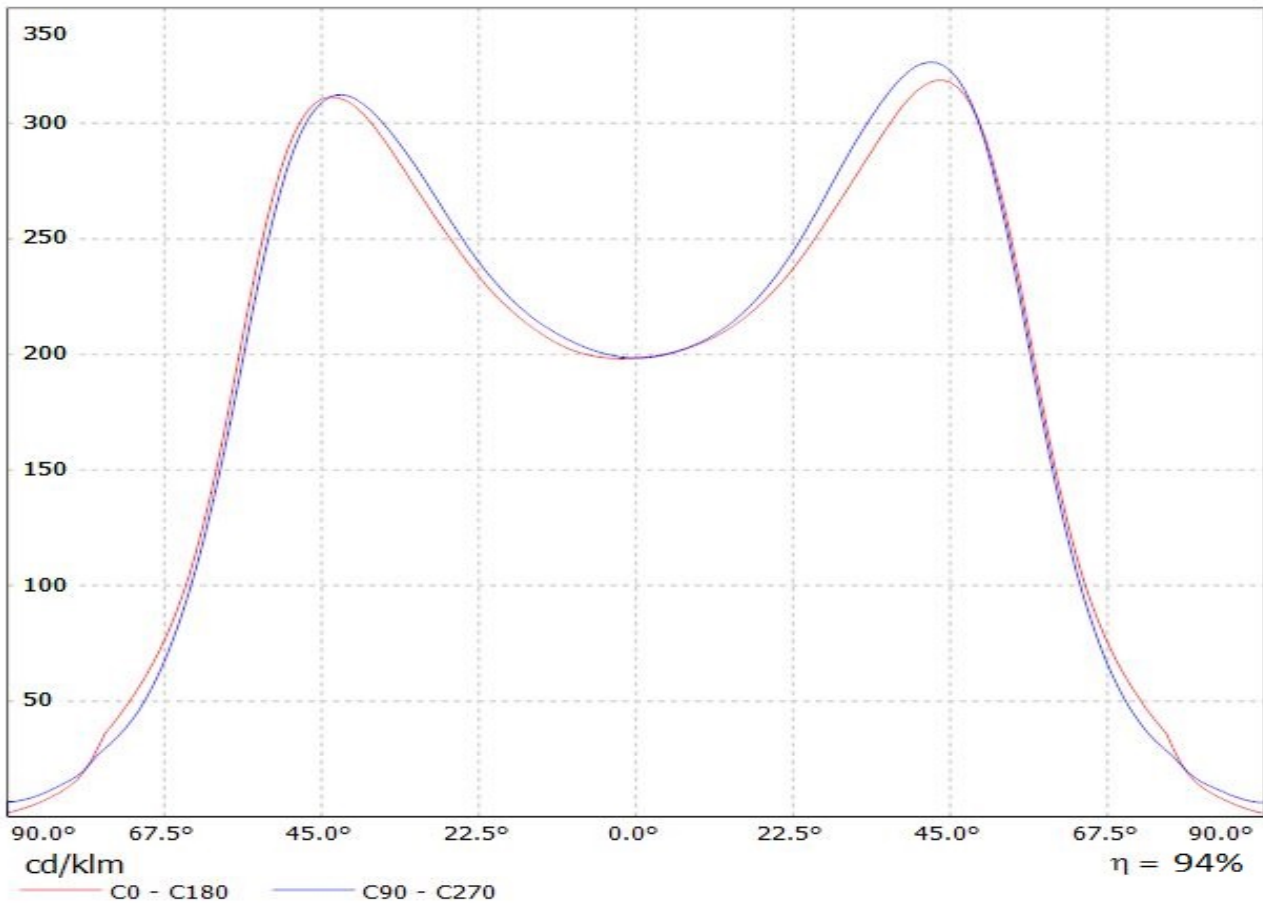

Luminaire: LEDiL Oy C13937_STRADA-2X2-C-STP_(Tridonic_Module_RLE_G1)
Lamps: 1 x Tridonic_Module_RLE_G1_2288lm@700mA_P=16W_I=0.700A

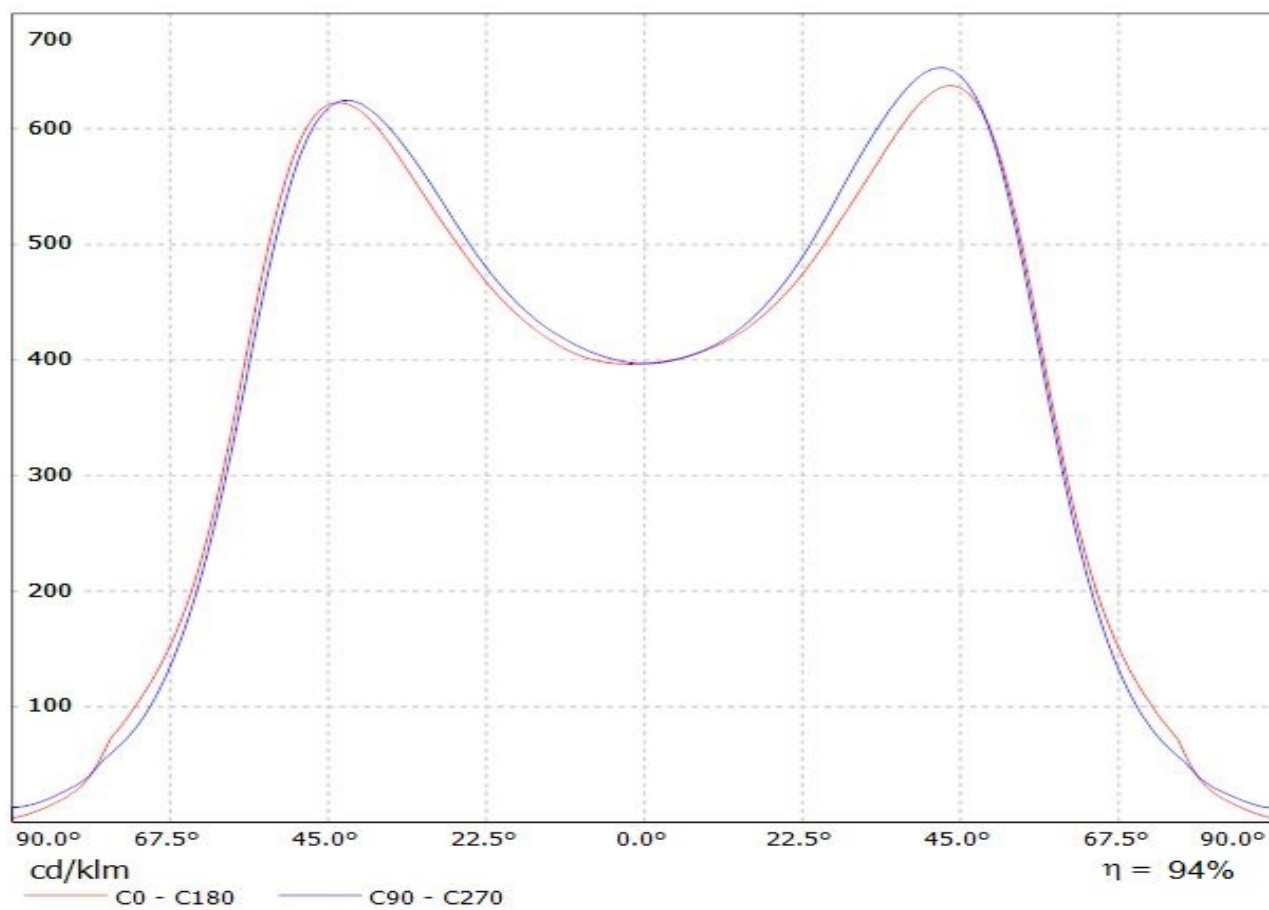

Luminaire: LEDiL Oy C13937_STRADA-2X2-C-STP_(Tridonic_Module_RLE_G1)
Lamps: 1 x Tridonic_Module_RLE_G1_2288lm@700mA_P=16W_I=0.700A

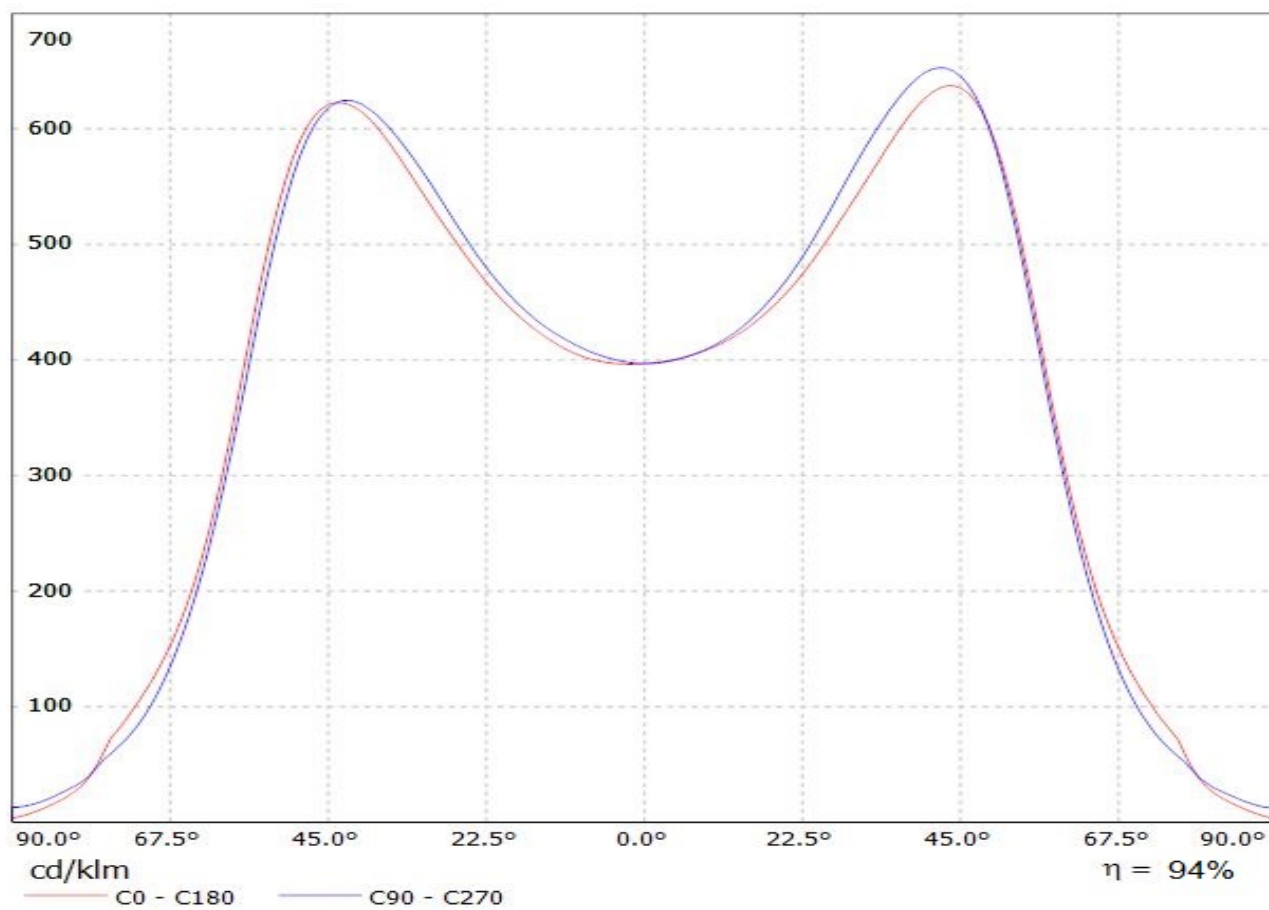

Luminaire: LEDiL Oy C13937_STRADA-2X2-C-STP_(XP-G2)
Lamps: 1 x Cree_XP-G2_(XPGBWT-L1-000-00-G51)_411.002lm@250mA_P=2.95164W_I=0.250A

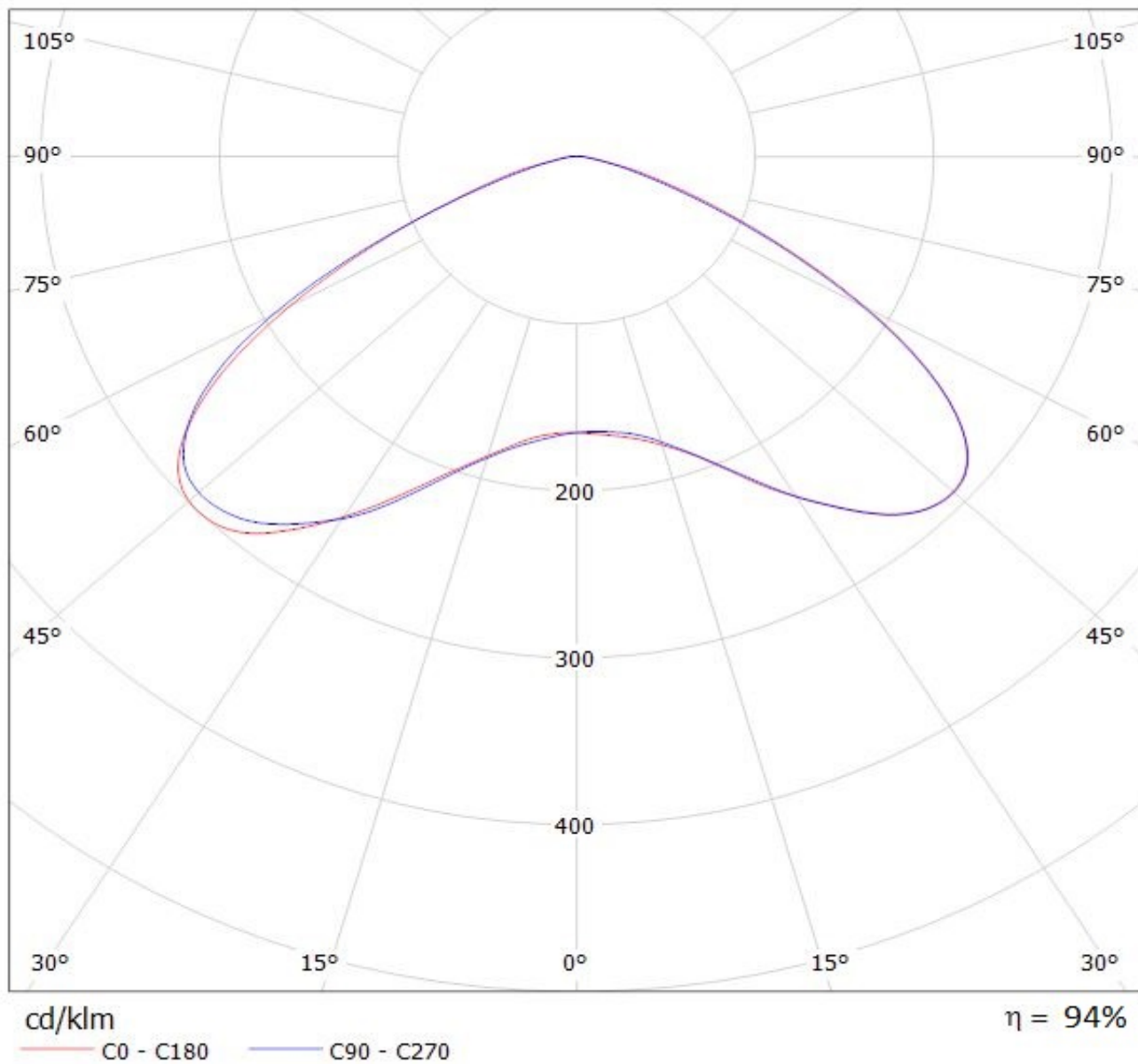

Luminaire: LEDiL Oy C13937_STRADA-2x2-C-STP_(XP-L)

Lamps: 1 x CREE_XP-L_2x2_(XPLAWT-0-1B0-V40-00-0001)_504.373lm@250mA_CCT=7600K_P=2.79963W_I=249.9mA

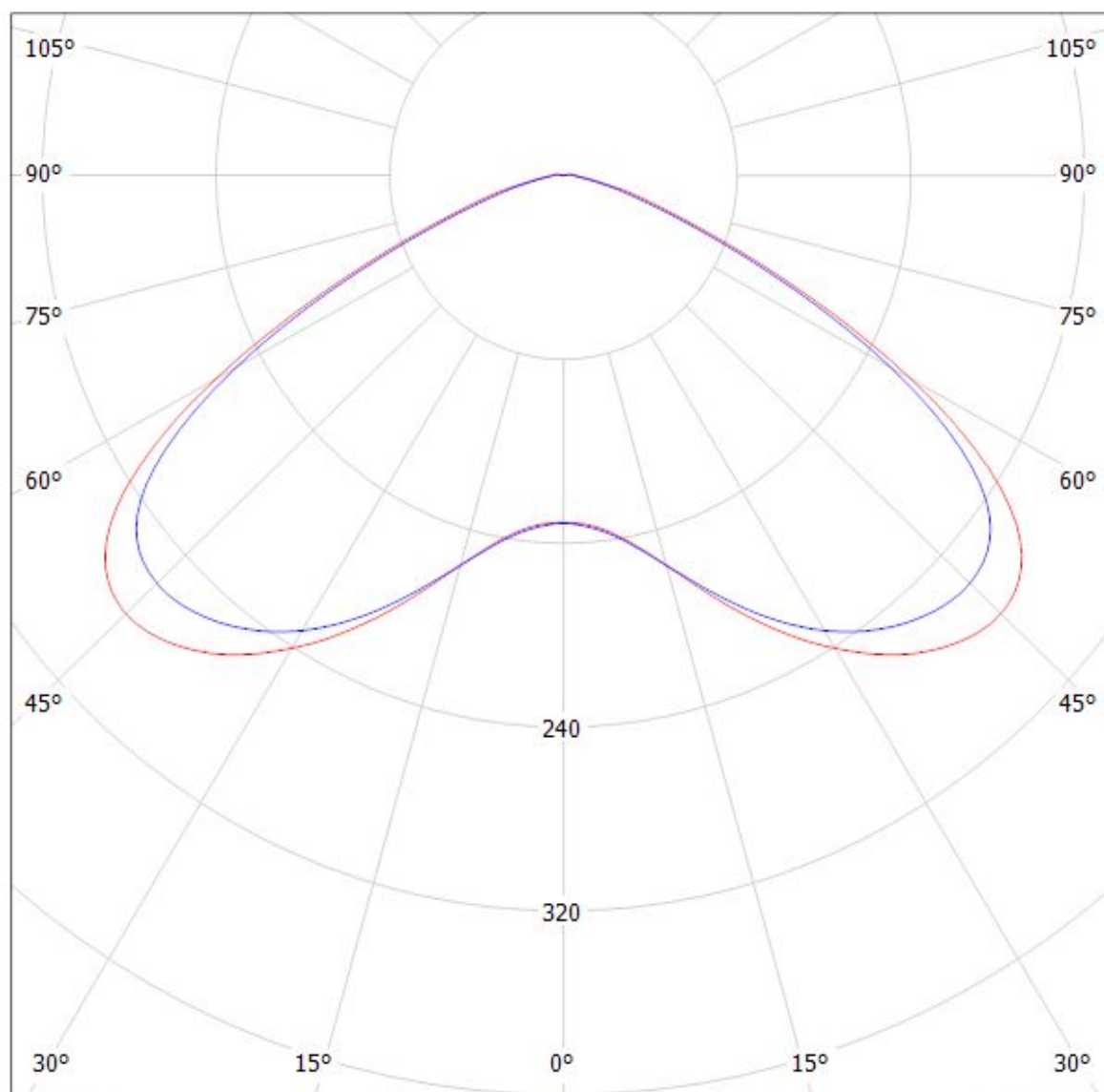

cd/klm

$\eta = 92\%$

— C0 - C180 — C90 - C270

Luminaire: LEDiL Oy C13937_STRADA-2X2-C-STP_(XP-L_HI)
Lamps: 1 x Cree_XP-L_HI_(2x2)_(XPLAWT-H-5A3-U60-013-0001)
_455.077lm@250mA_P=2.84011W_I=0,2499A

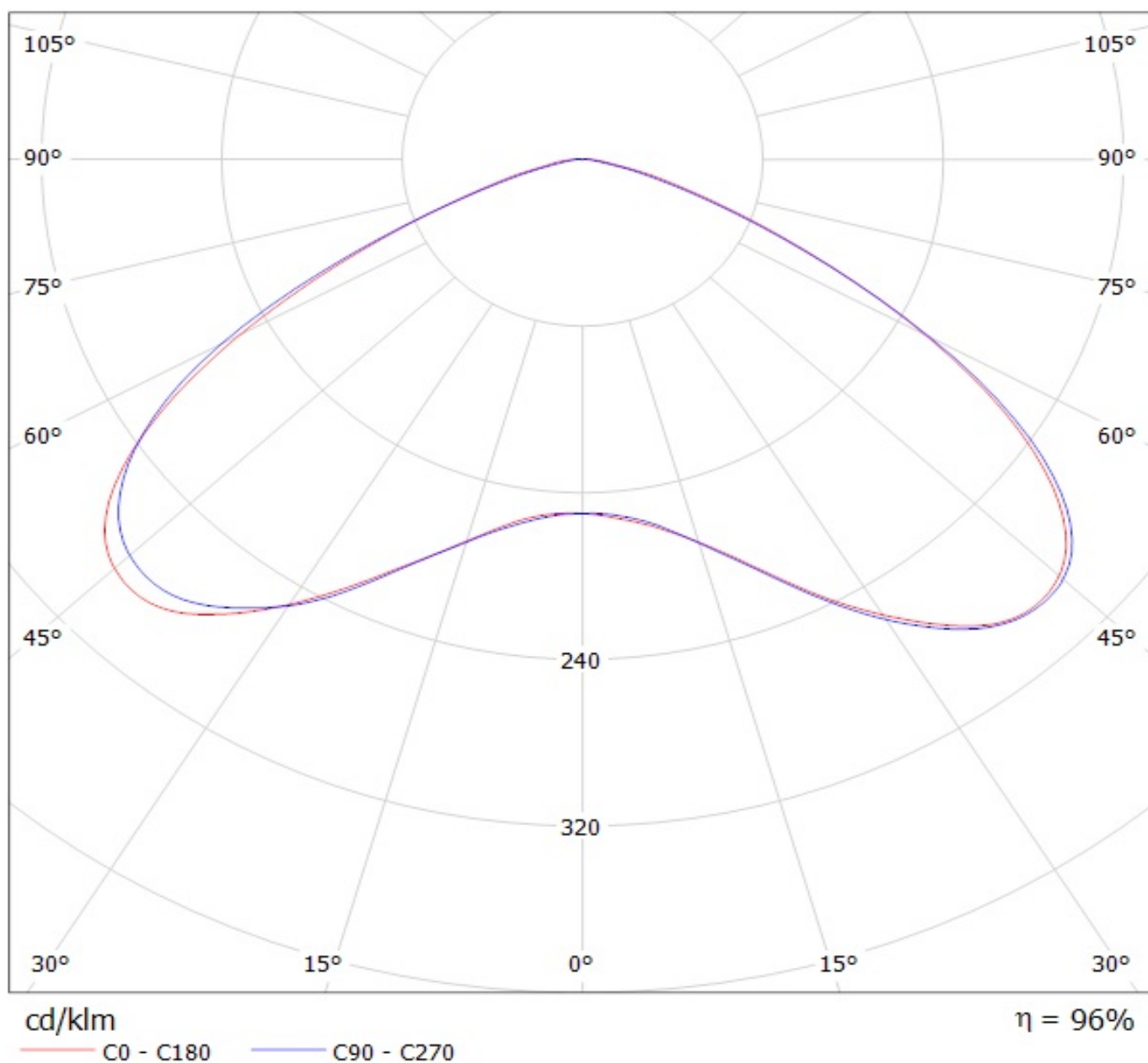

Luminaire: Ledil C13937_STRADA-2X2-C-STP_(XP-G3)

Lamps: 1 x Cree_XP-G3_2x2_(XPGDWT-B1-3C0-S4-0-01)_516.212lm@250mA_P=2.78875W_I=0.250A

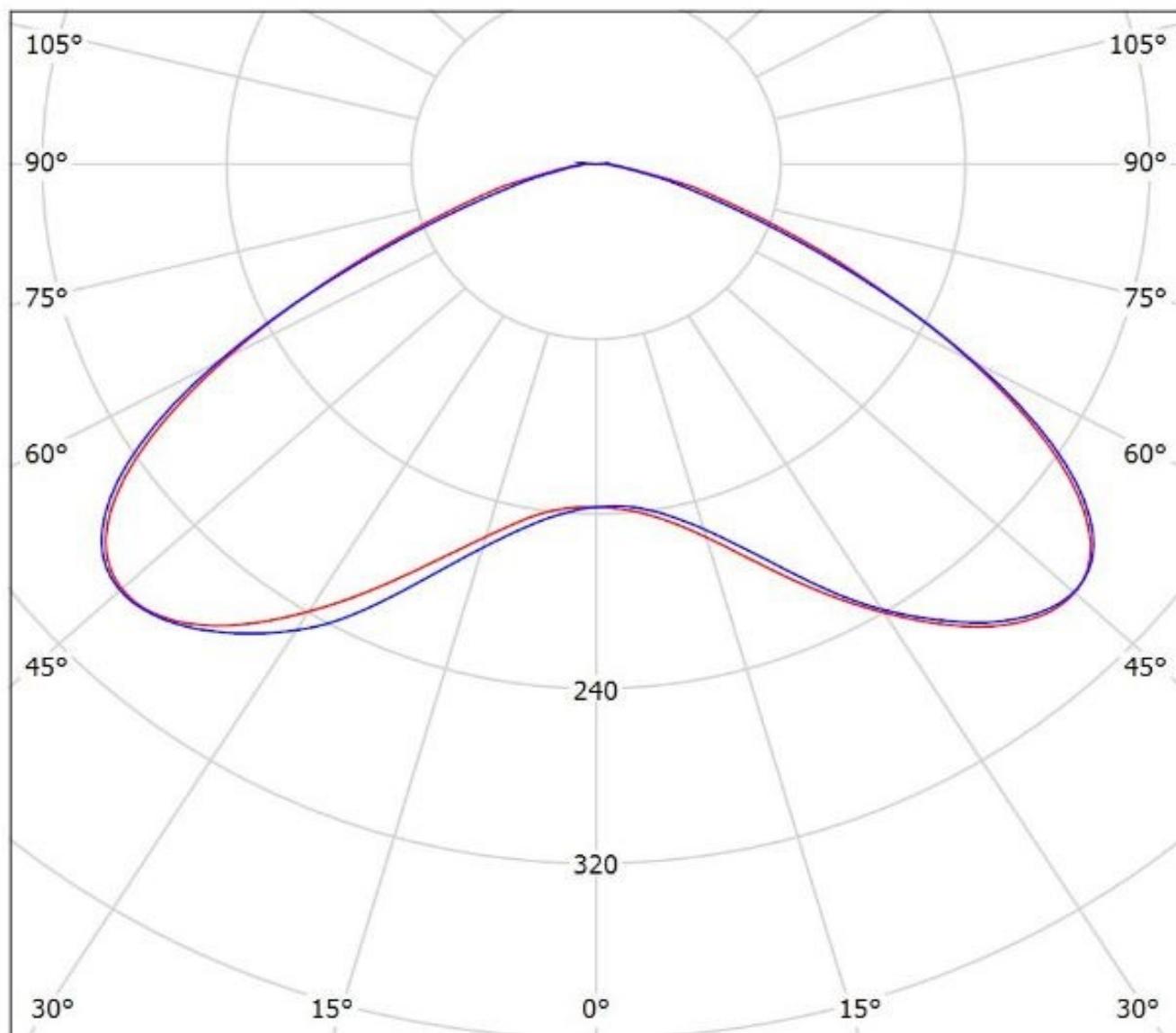

cd/klm

— C0 - C180 — C90 - C270

$\eta = 94\%$

Luminaire: Ledil C13937_STRADA-2X2-C-STP_(XP-L2)

Lamps: 1 x Cree_XP-L2_2x2_(XPLBWT-00-0000-000BV50E3)550.93lm@250mA_P=2.7815W_I=0.25A

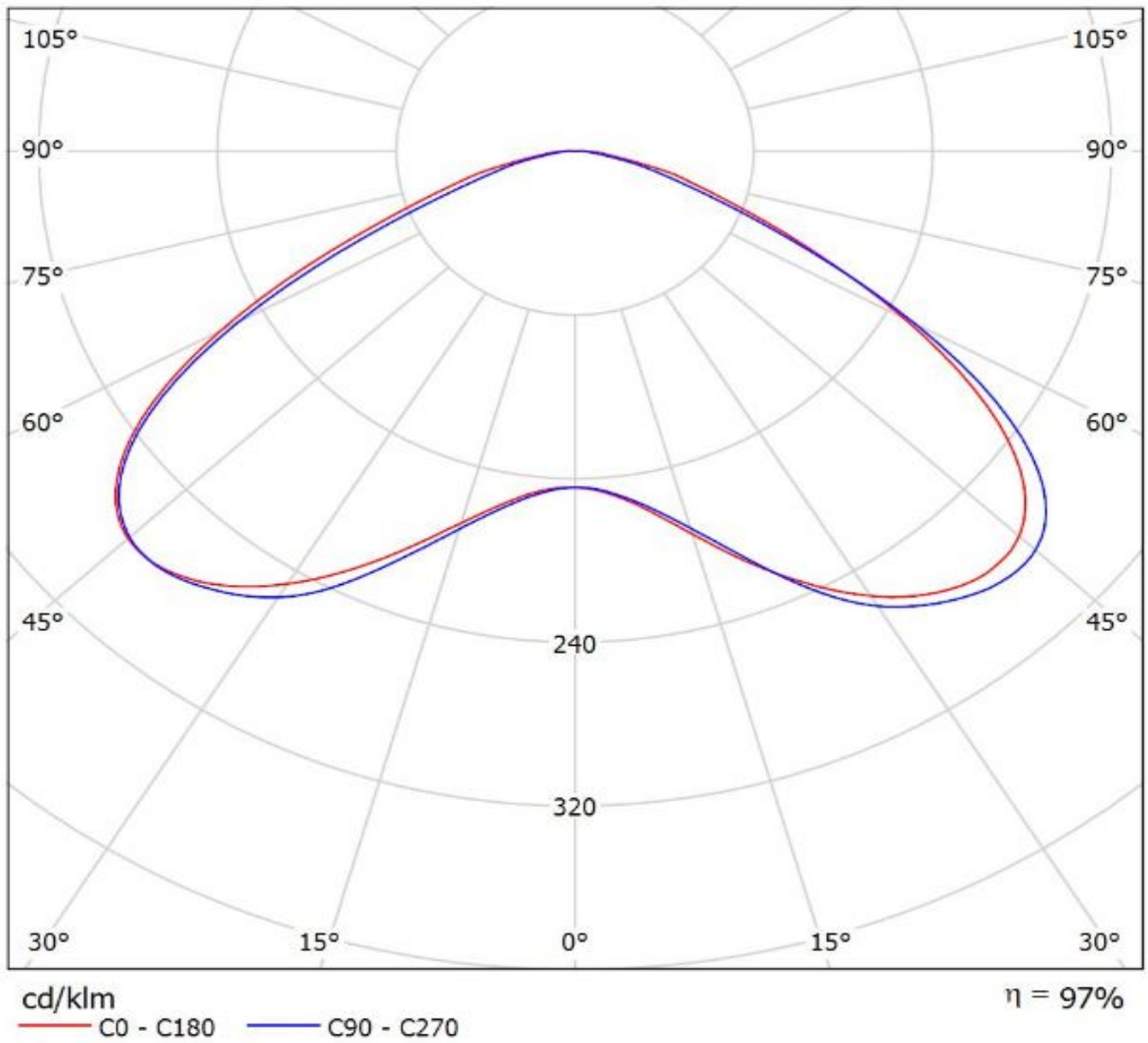

Luminaire: Ledil C13937_STRADA_2x2-C-STP_(H35C1)
Lamps: 1 x LG_H35C1_2x2_477.216lm@250mA_P=2.87475W_I=0.250A

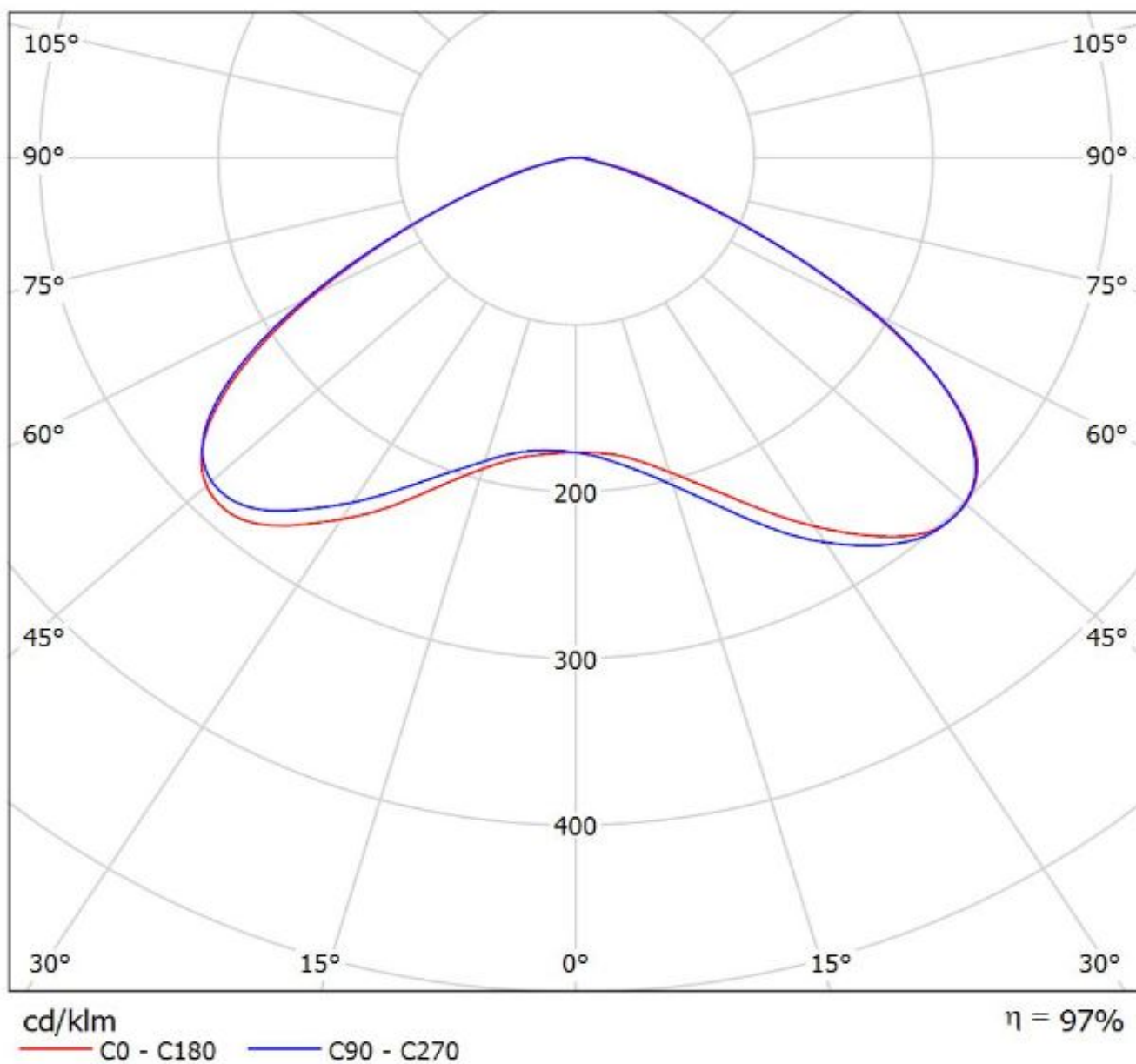

Luminaire: Ledil C13937_STRADA-2X2-C-STP_(Luxeon_MZ)

Lamps: 1 x Philips_Lumileds_Luxeon_MZ_(LMZ7-QW57)_(2x2)_427.268lm@250mA_P=2.734W_I=0.2500A

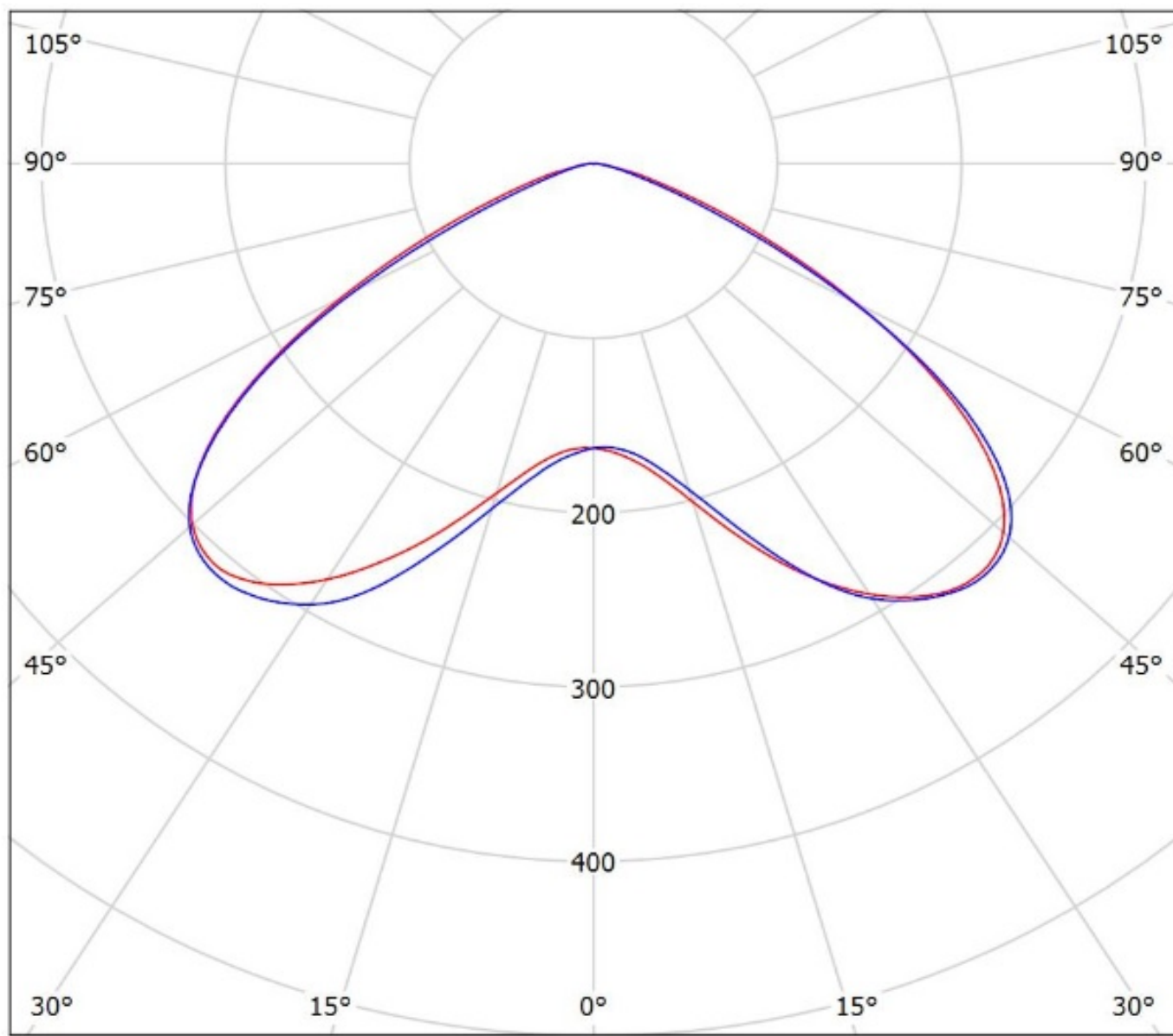

cd/klm

— C0 - C180 — C90 - C270

$\eta = 97\%$

Luminaire: LEDiL Oy C13937_STRADA-2X2-C-STP_(Luxeon_5050)

Lamps: 1 x Luxeon_5050_2x2_1270.76lm@80mA_CCT=5700K_P=7.35815W_I=0.080A_70CRI

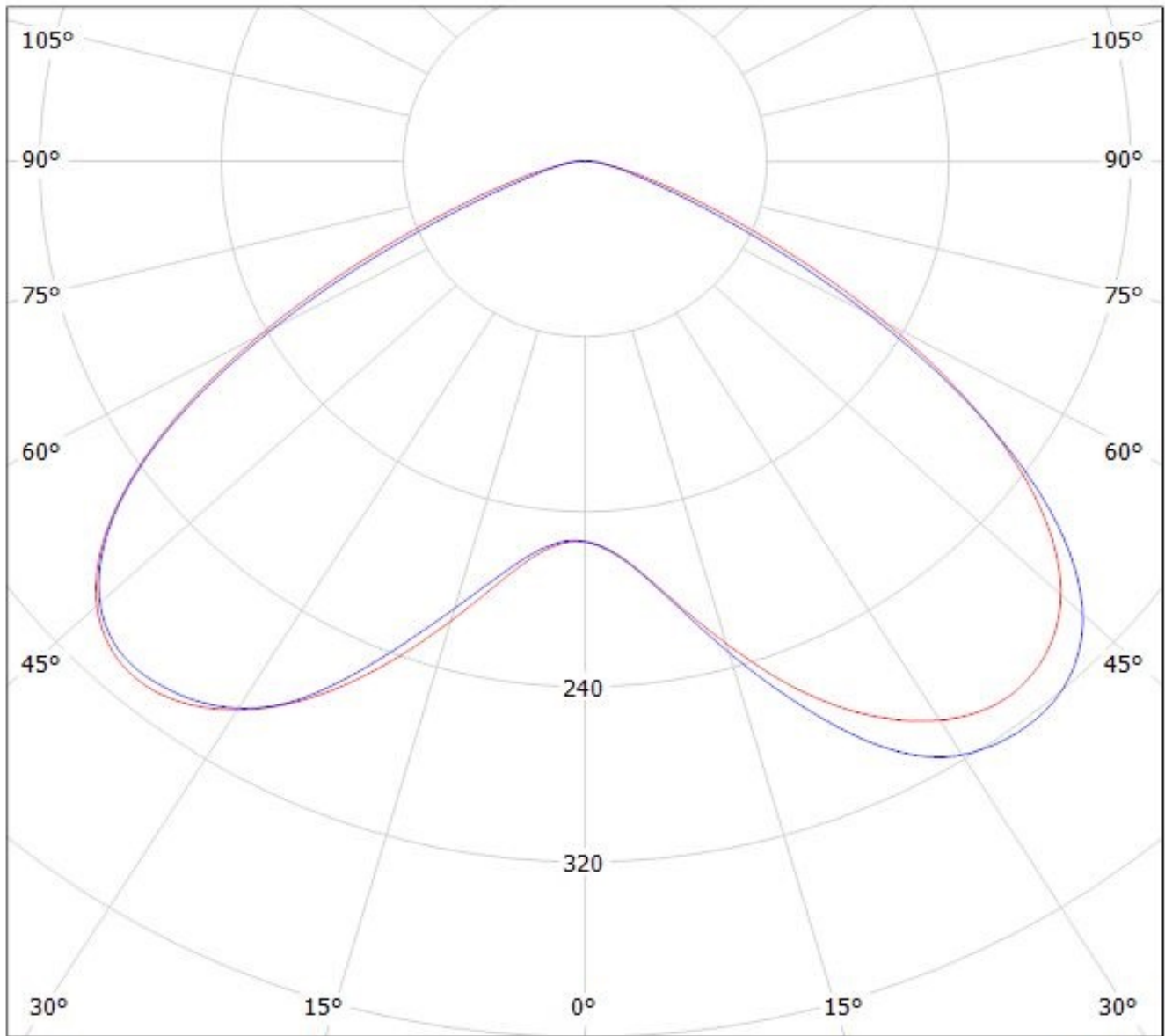

cd/klm

— C0 - C180

— C90 - C270

$\eta = 94\%$

Luminaire: LEDiL Oy C13937_STRADA-2X2-C-STP_(Luxeon_TX)
Lamps: 1 x Luxeon_TX_(L1T2-3585)_318.556lm@250mA_P=2.78827W_η=0.250A

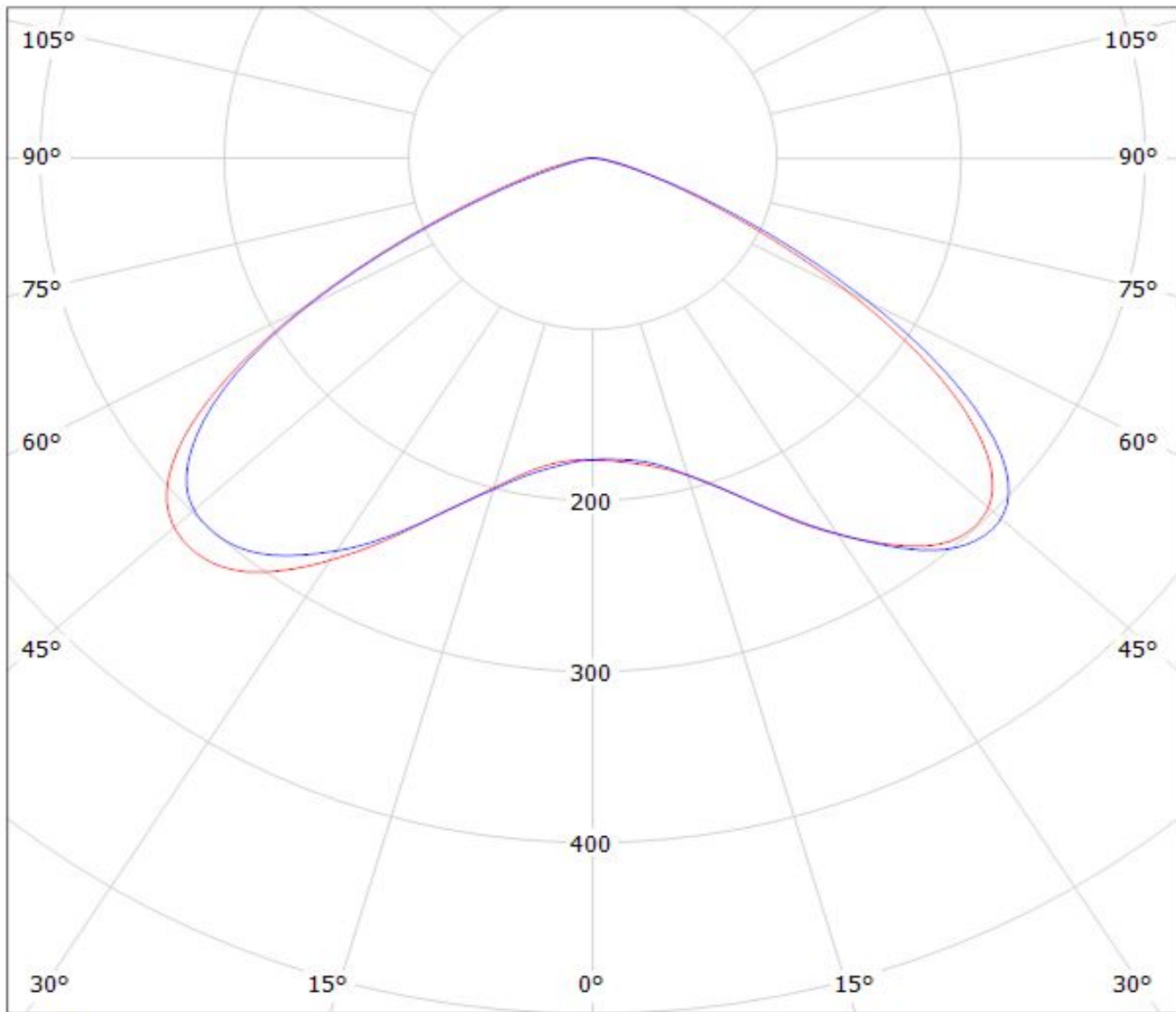

$\eta = 96\%$

cd/klm

— C0 - C180 — C90 - C270

Luminaire: LEDiL Oy C13937_STRADA-2X2-C-STP_(NVSW319AE)
Lamps: 1 x Nichia_NVSW319AE_499.093lm@250mA_P=2.79052W_I=0.25A

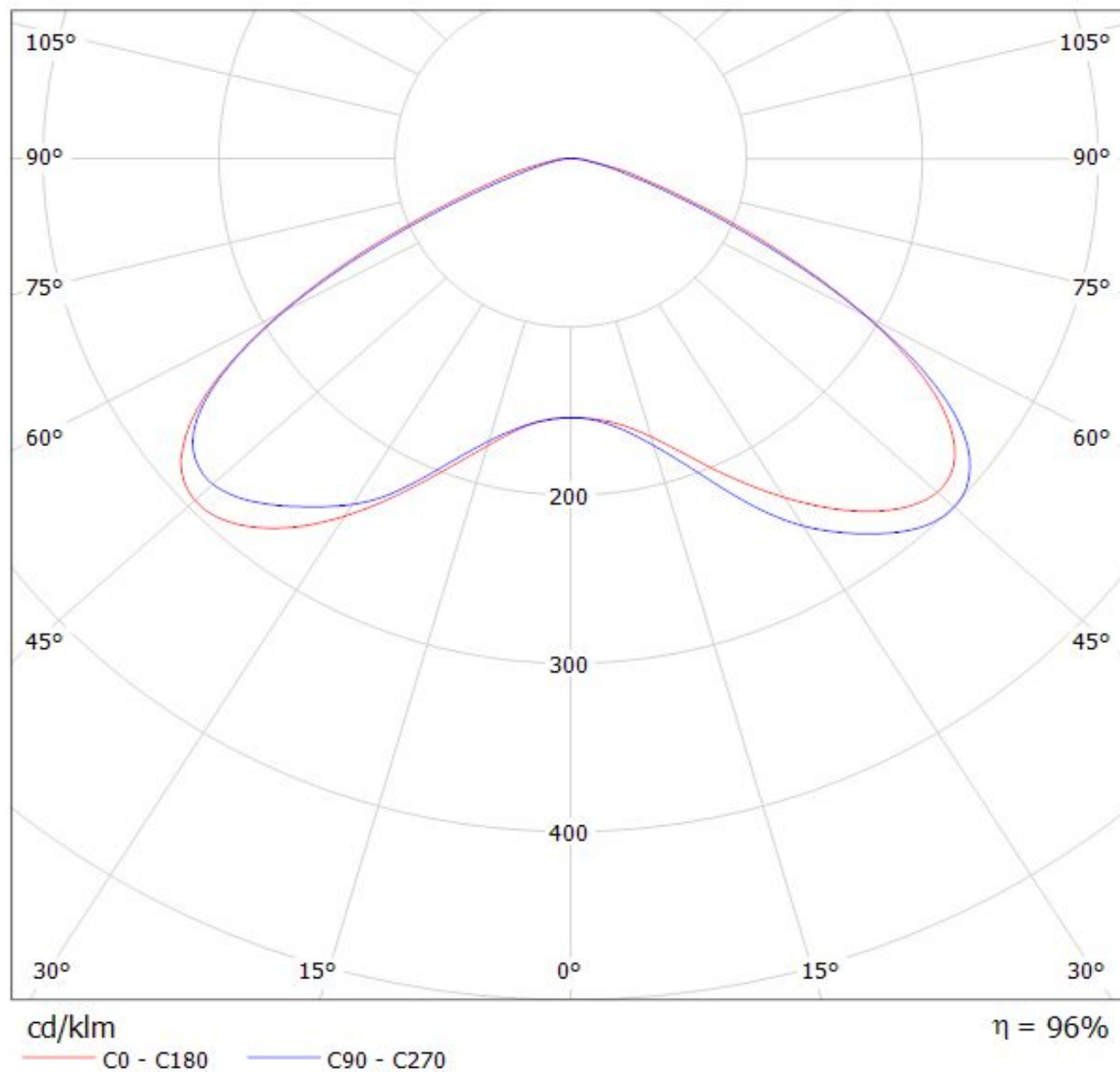

Luminaire: LEDiL Oy C13937_STRADA-2X2-C-STP_(Oslon_Square_PC_2x2)
Lamps: 1 x Osram_Oslon_Square_PC_2x2_(GWCSSRM1.PC)
_411.322lm@250mA_P=2.85186W_I=0,2499A

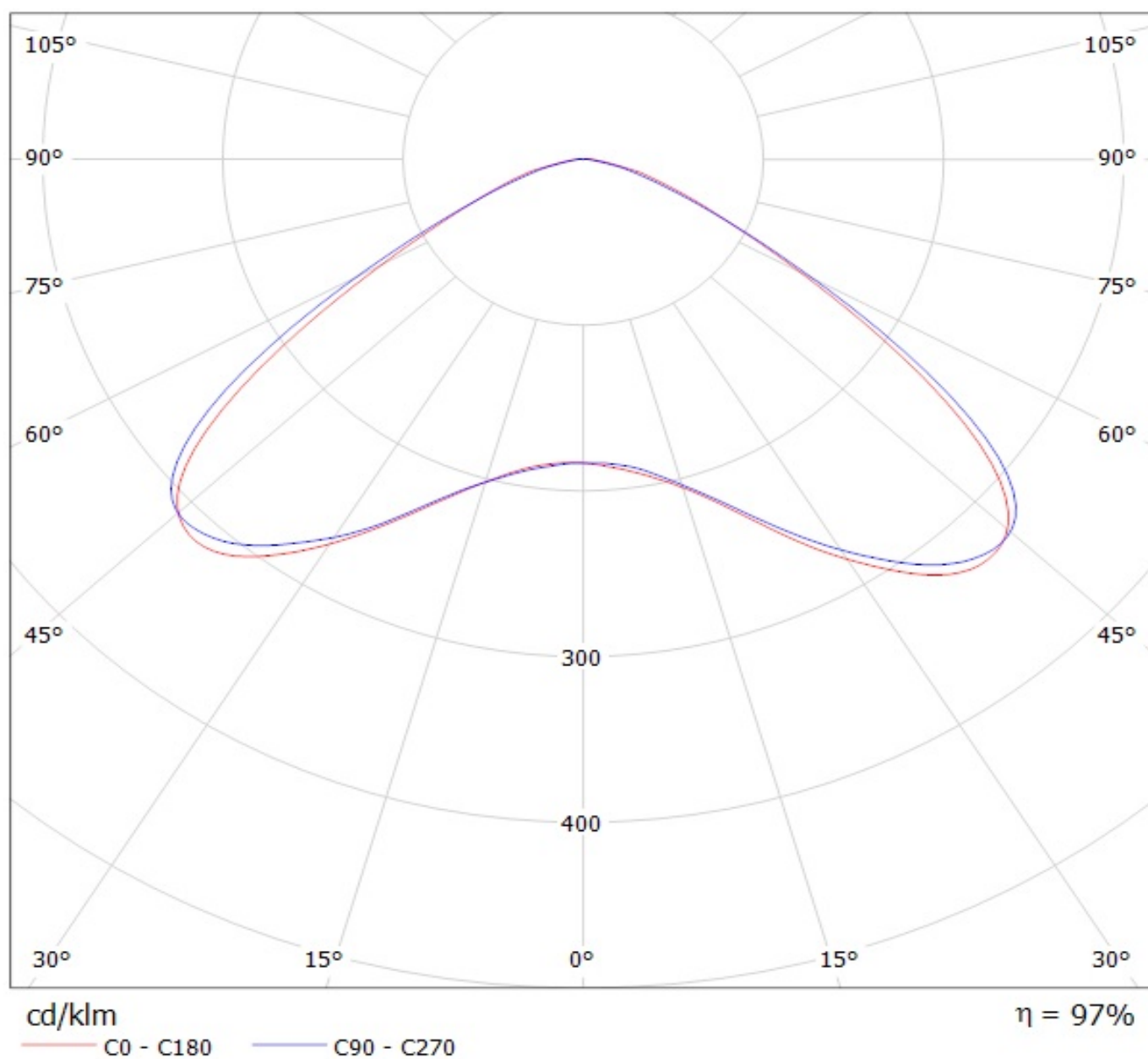

Luminaire: Ledil C13937_STRADA-2X2-C-STP_(Square_Gen3)

Lamps: 1 x Osram_Square_Gen3_(GW_CSSRM2.PM)_461.082lm@250mA_P=2.79075W_I=0.250A

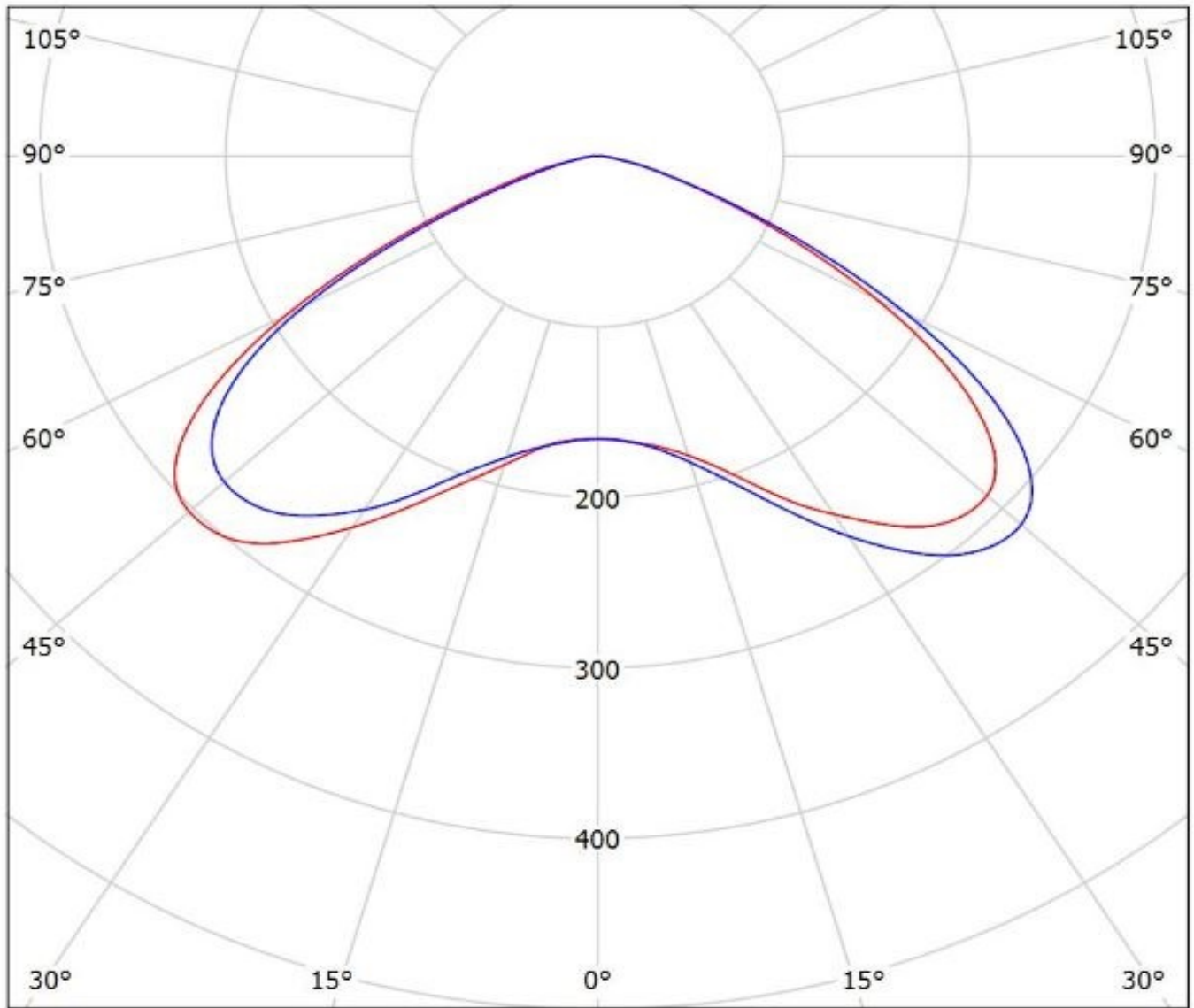

cd/klm

— C0 - C180 — C90 - C270

$\eta = 94\%$

Luminaire: Ledil Oy C13937STRADA-2X2-C-STP_(Duris_S8_Gen2)_SIMULATED
Lamps: 1 x OSRAM_DURIS S8 GEN2 5050 package

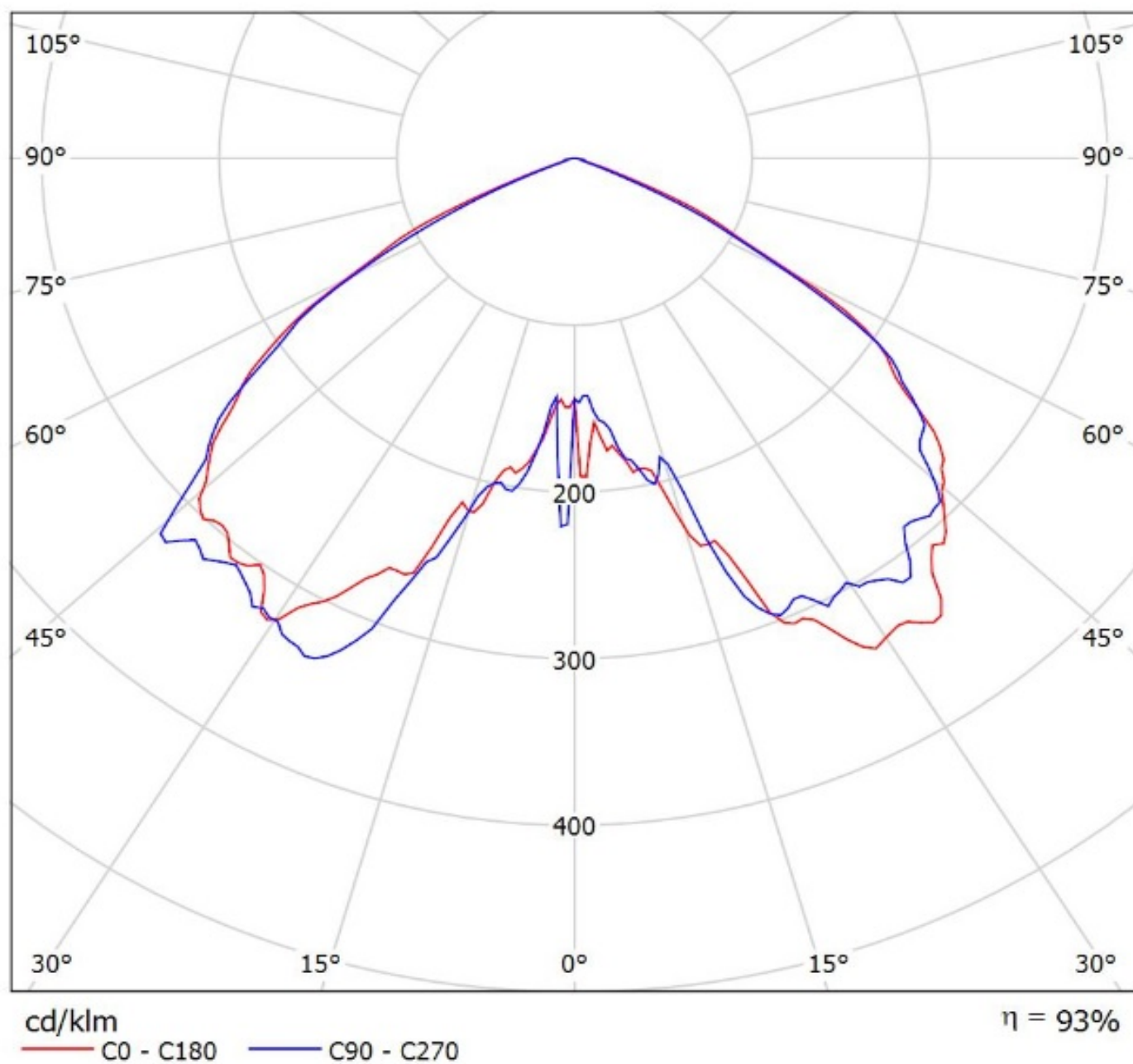

Luminaire: LEDiL Oy C13937_STRADA-2X2-C-STP_(Fortimo_F-Flex_2x8_740DAG3)
Lamps: 1 x Philips_Fortimo_F-Flex_2x8_740DAG3_1780.2lm@250mA_P=11.6112W_η=0.2498A

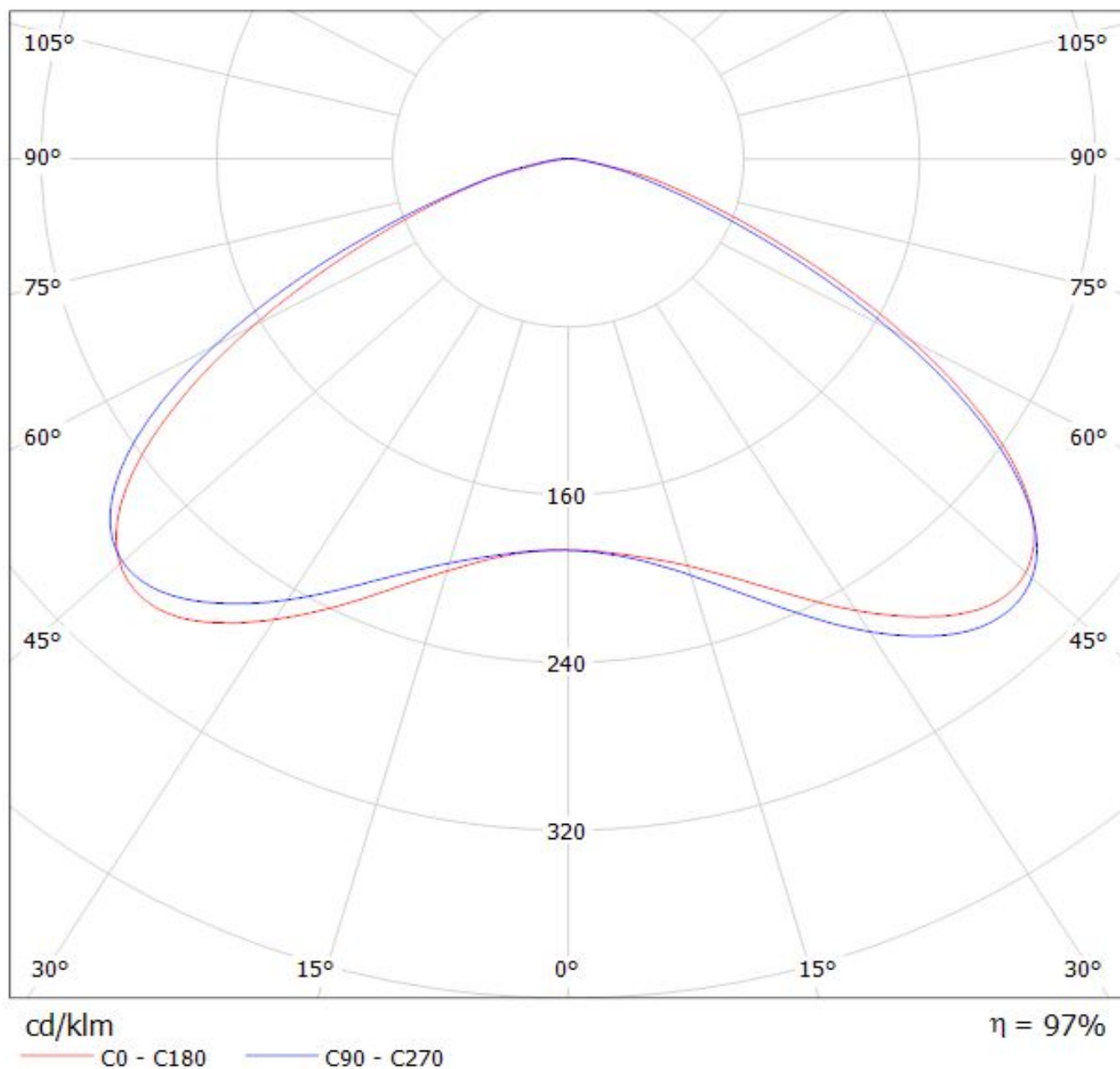

Luminaire: LEDiL Oy C13937_STRADA-2X2-C-STP_(LH351Z)

Lamps: 1 x SAMSUNG_LH351Z_2x2_369.77lm@250mA_P=2.86371W_I=249.8mA

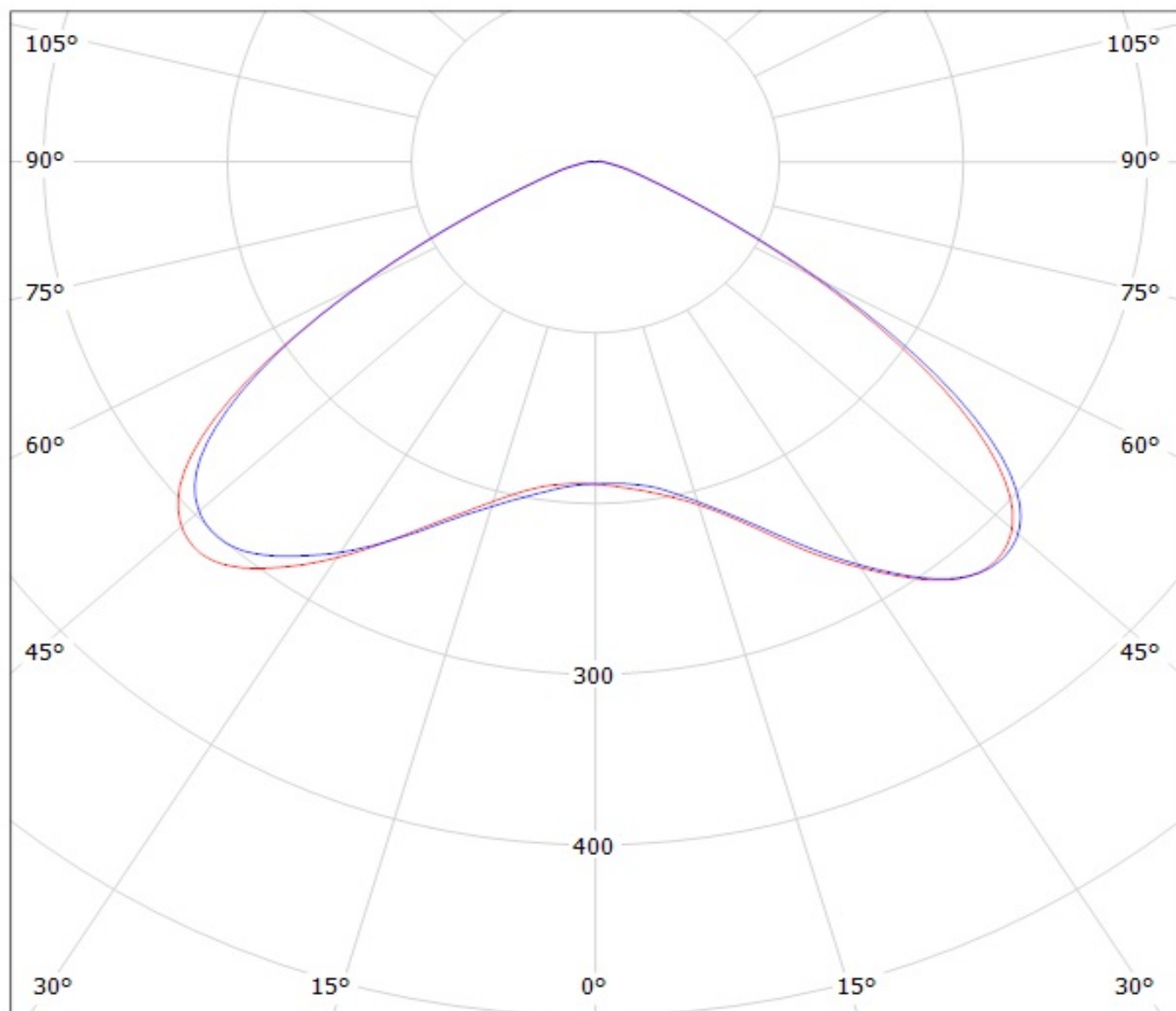

cd/klm

— C0 - C180

— C90 - C270

$\eta = 94\%$

Luminaire: Ledil C13937_STRADA-2X2-C-STP_(LH351B)

Lamps: 1 x Samsung_LH351B_2x2_444.178lm@250mA_P=2.8535W_I=0.25A

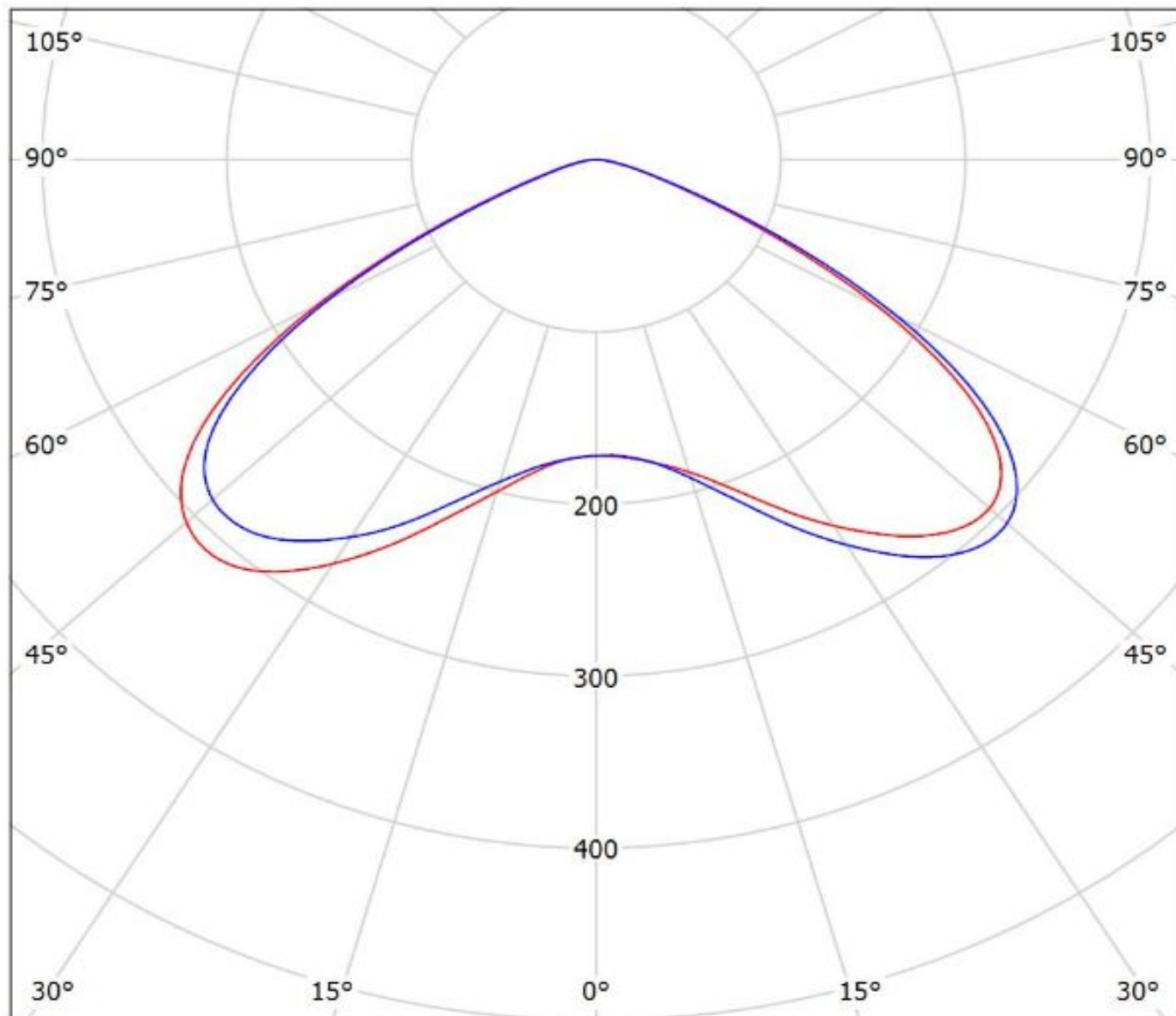

cd/klm

— C0 - C180

— C90 - C270

$\eta = 97\%$

Luminaire: Ledil C13937_STRADA-2X2-C-STP_(LH508A)

Lamps: 1 x Samsung_LH508A_2x2_2060.04lm@160mA_CCT=5000K_CRI=80_P=15.5405W_I=0.16A

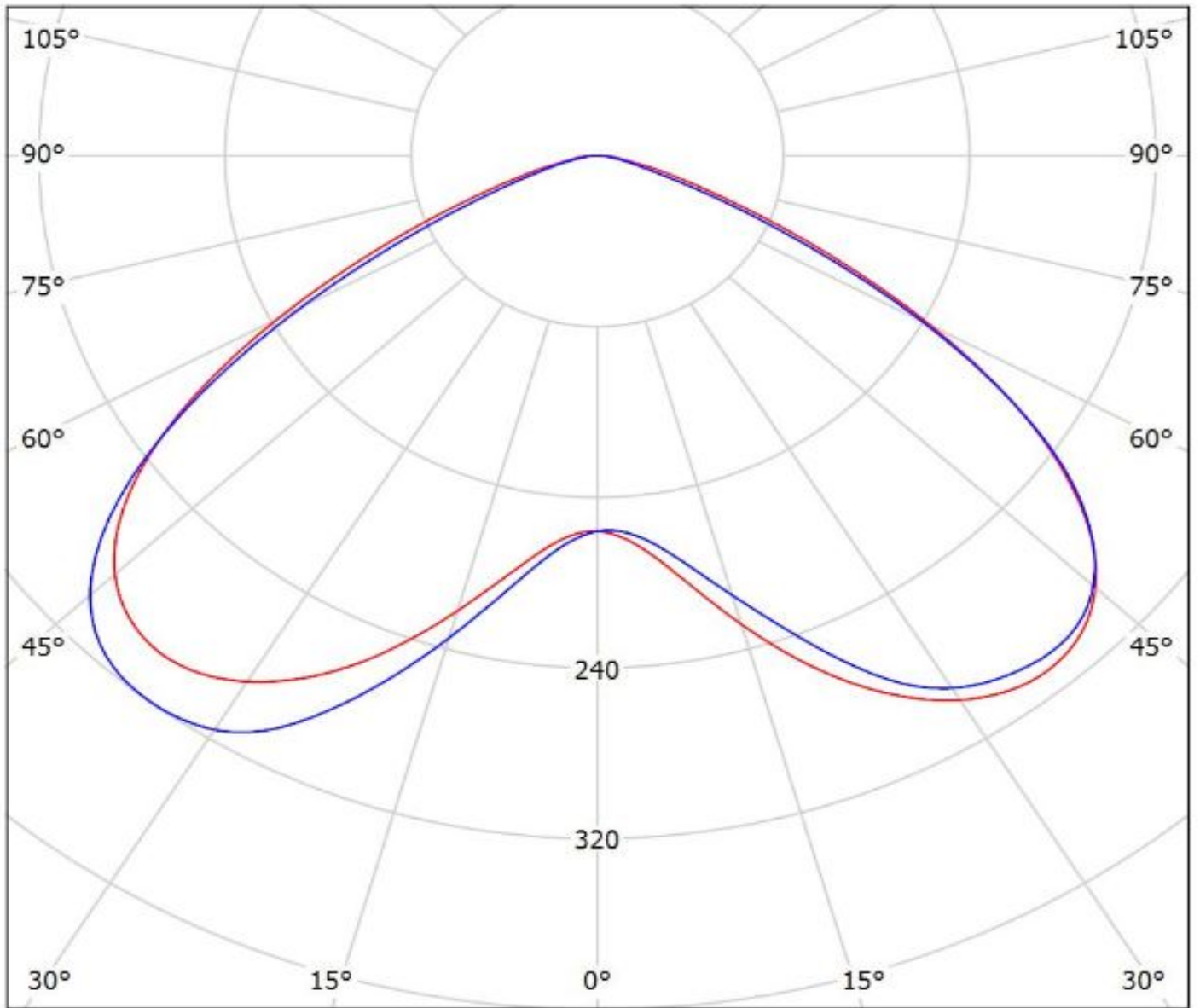

cd/klm

— C0 - C180 — C90 - C270

$\eta = 98\%$

Ledil C13937_STRADA-2X2-C-STP_(TL1L4) / LDC (Polar)

Luminaire: Ledil C13937_STRADA-2X2-C-STP_(TL1L4)

Lamps: 1 x Toshiba_TL1L4_2x2_(TL1L4-DW0)_472.639lm@250mA_CCT=6500K_P=2.9W_I=0.25A

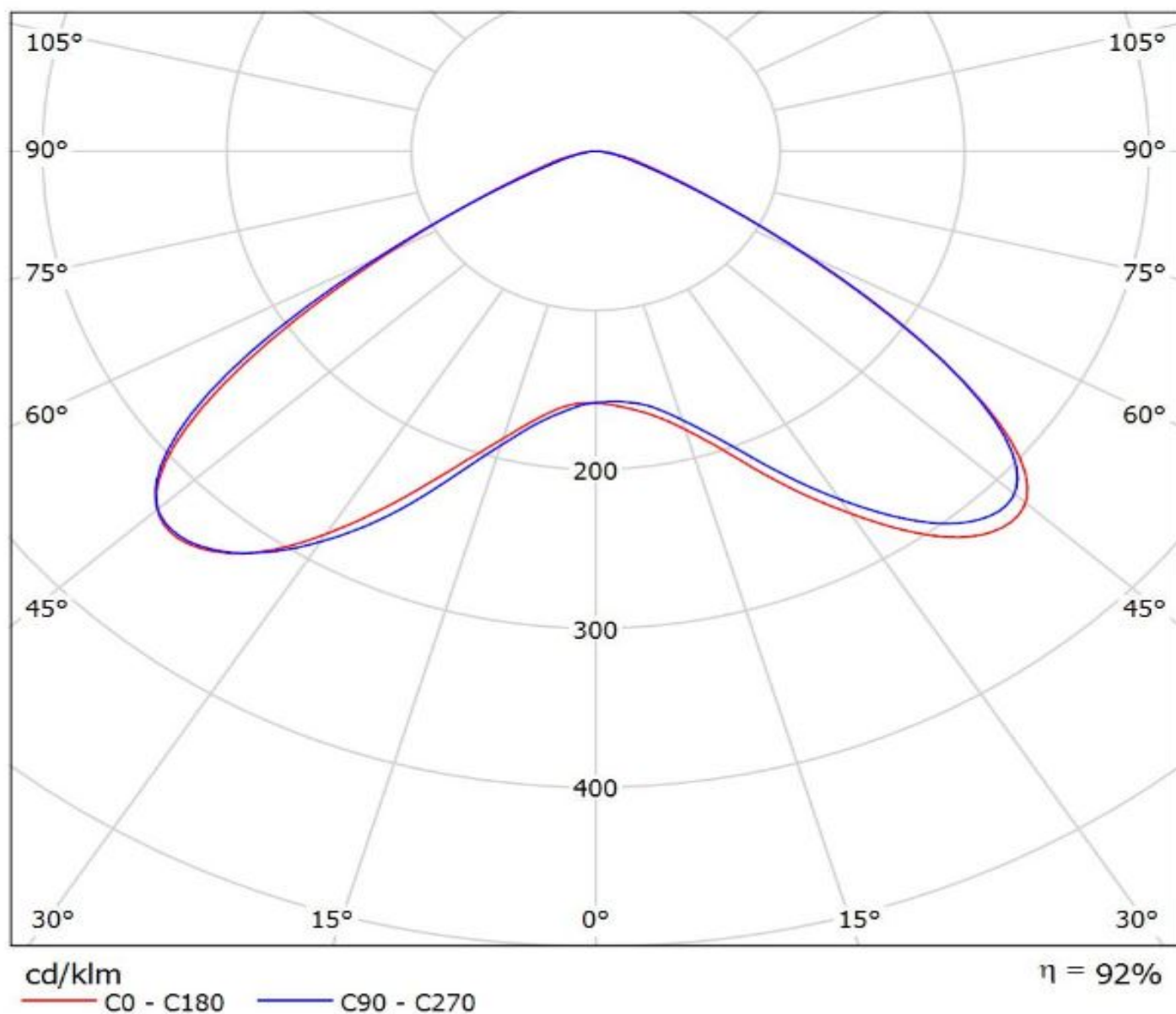

Luminaire: LEDiL Oy C13937_STRADA-2X2-C-STP_(Tridonic_Module_RLE_G1)
Lamps: 1 x Tridonic_Module_RLE_G1_4576.03lm@700mA_P=32.0681W_I=0.700A

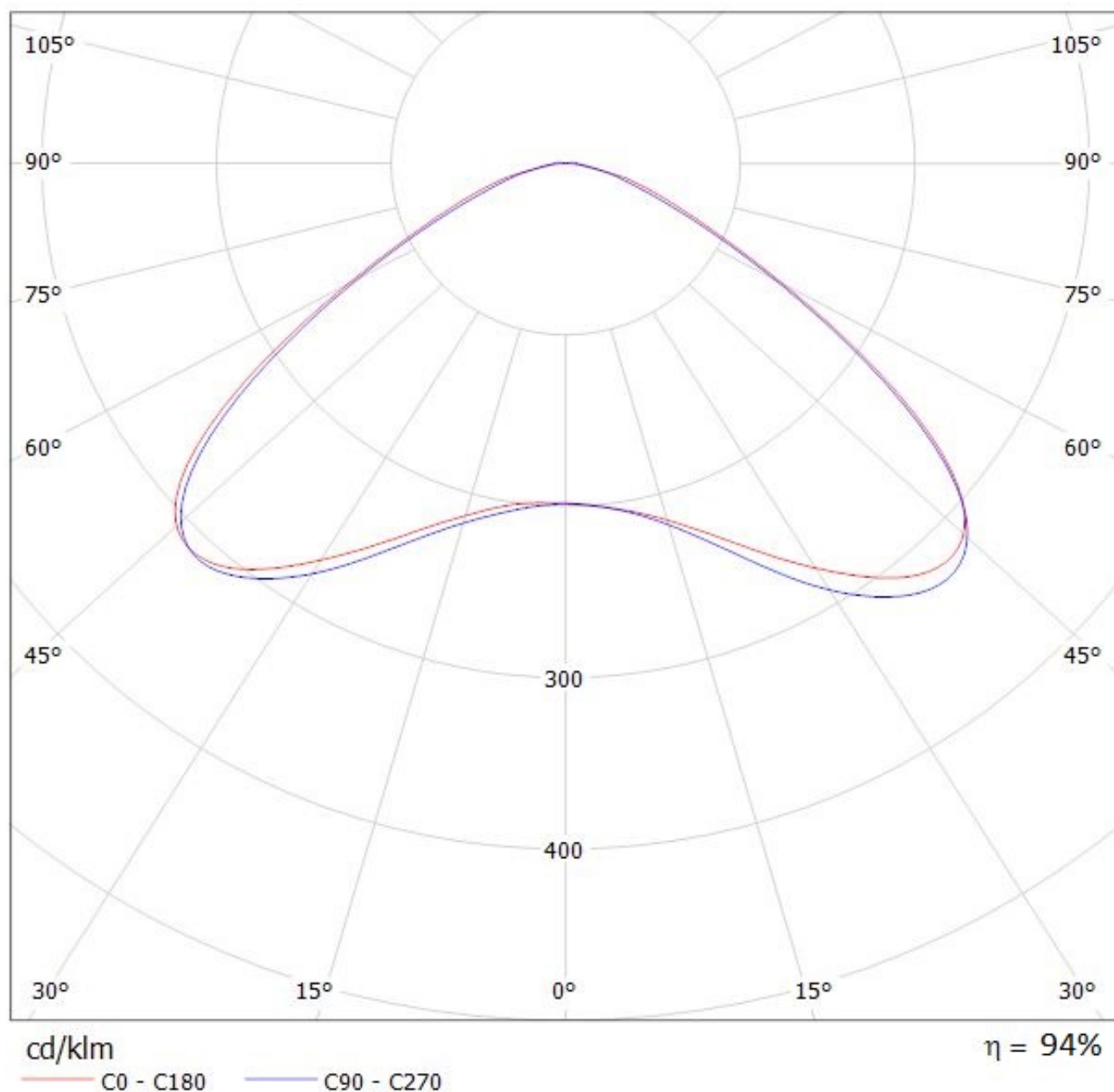

Luminaire: LEDiL Oy C13937_STRADA-2X2-C-STP_(Tridonic_Module_RLE_G1)
Lamps: 1 x Tridonic_Module_RLE_G1_4576.03lm@700mA_P=32.0681W_I=0.700A

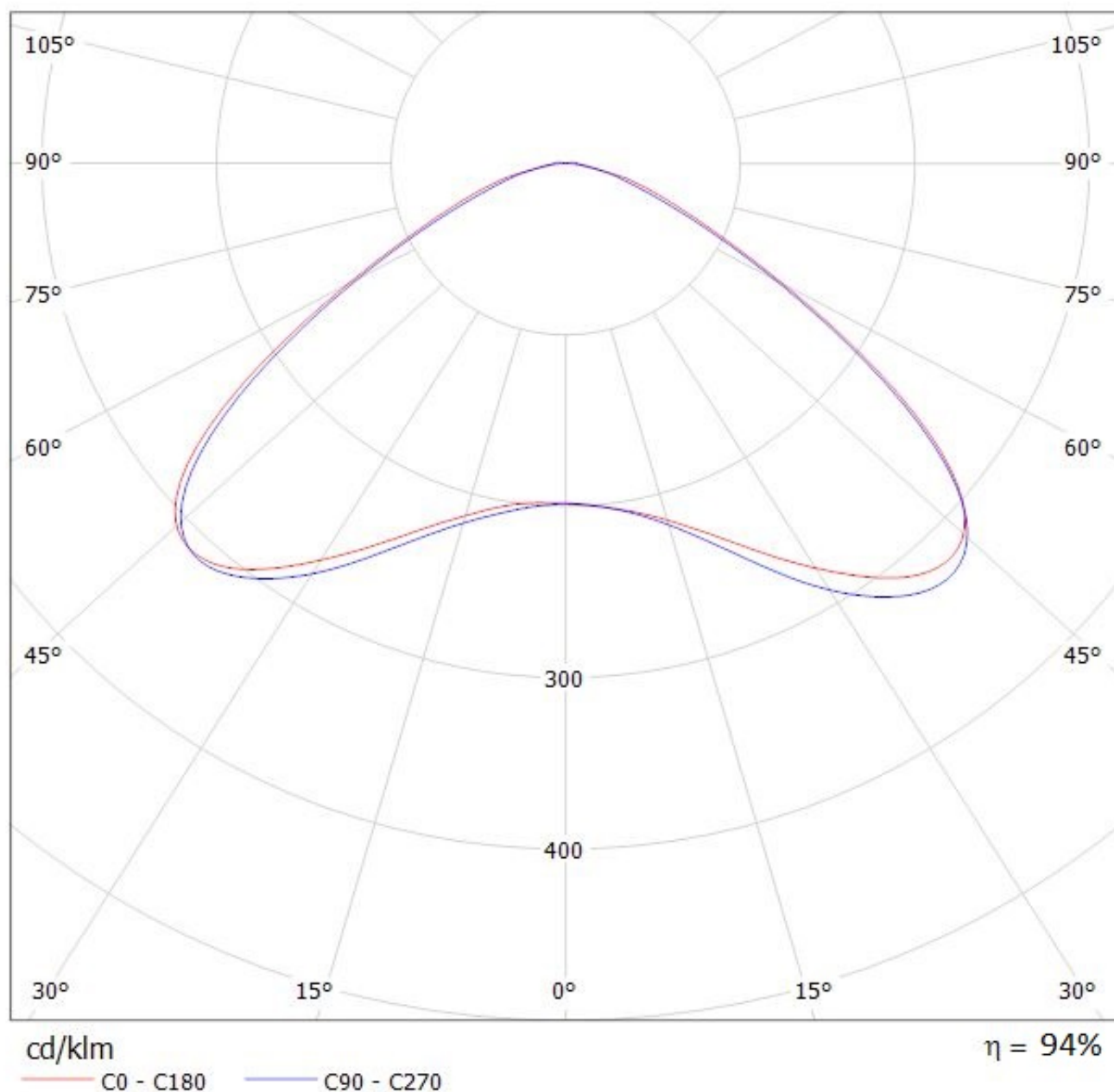

Luminaire: LEDiL Oy C13937_STRADA-2X2-C-STP_(Tridonic_Module_RLE_G1)
Lamps: 1 x Tridonic_Module_RLE_G1_2288lm@700mA_P=16W_I=0.700A

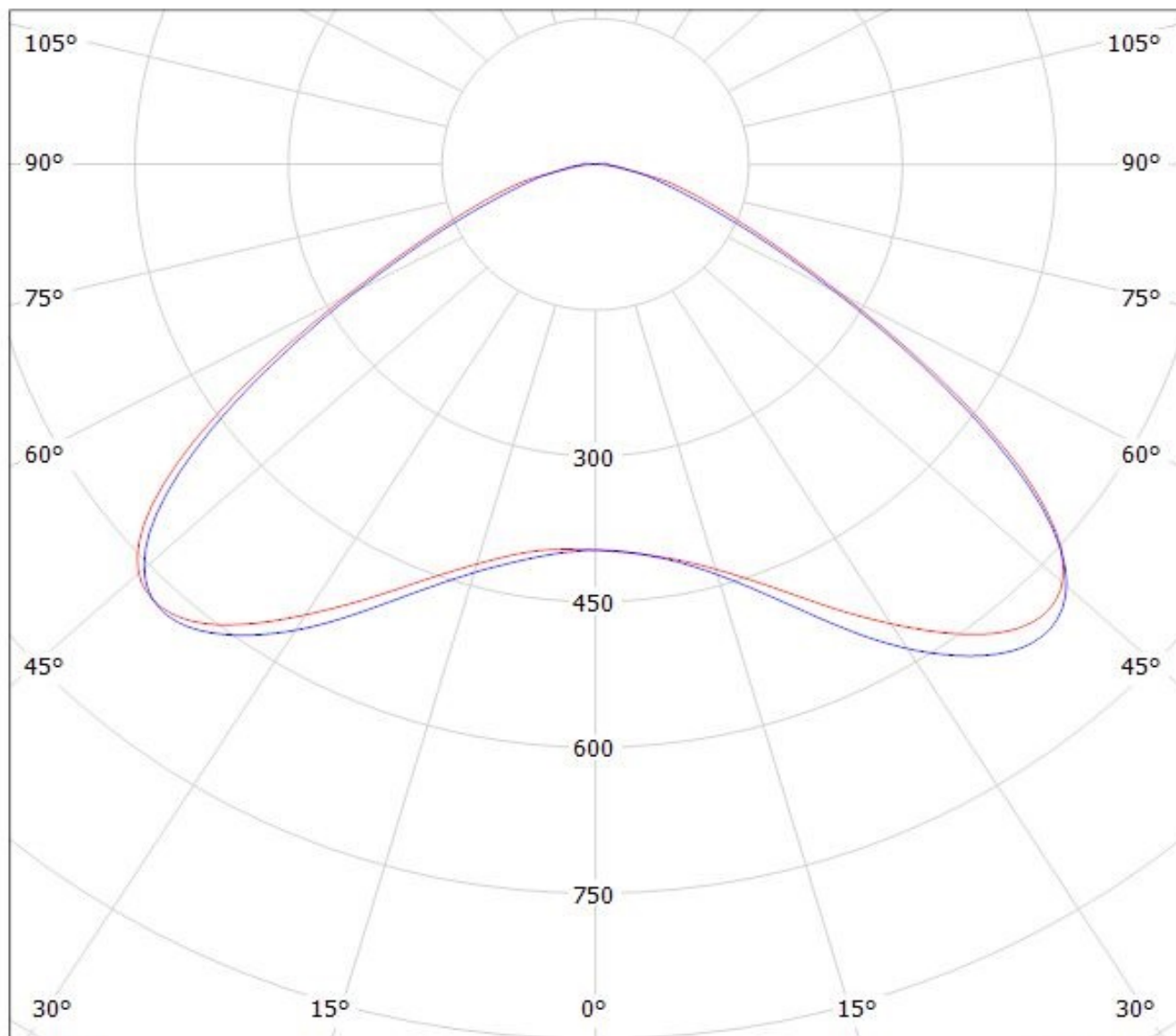

cd/klm

— C0 - C180

— C90 - C270

$\eta = 94\%$

Luminaire: LEDiL Oy C13937_STRADA-2X2-C-STP_(Tridonic_Module_RLE_G1)
Lamps: 1 x Tridonic_Module_RLE_G1_2288lm@700mA_P=16W_I=0.700A

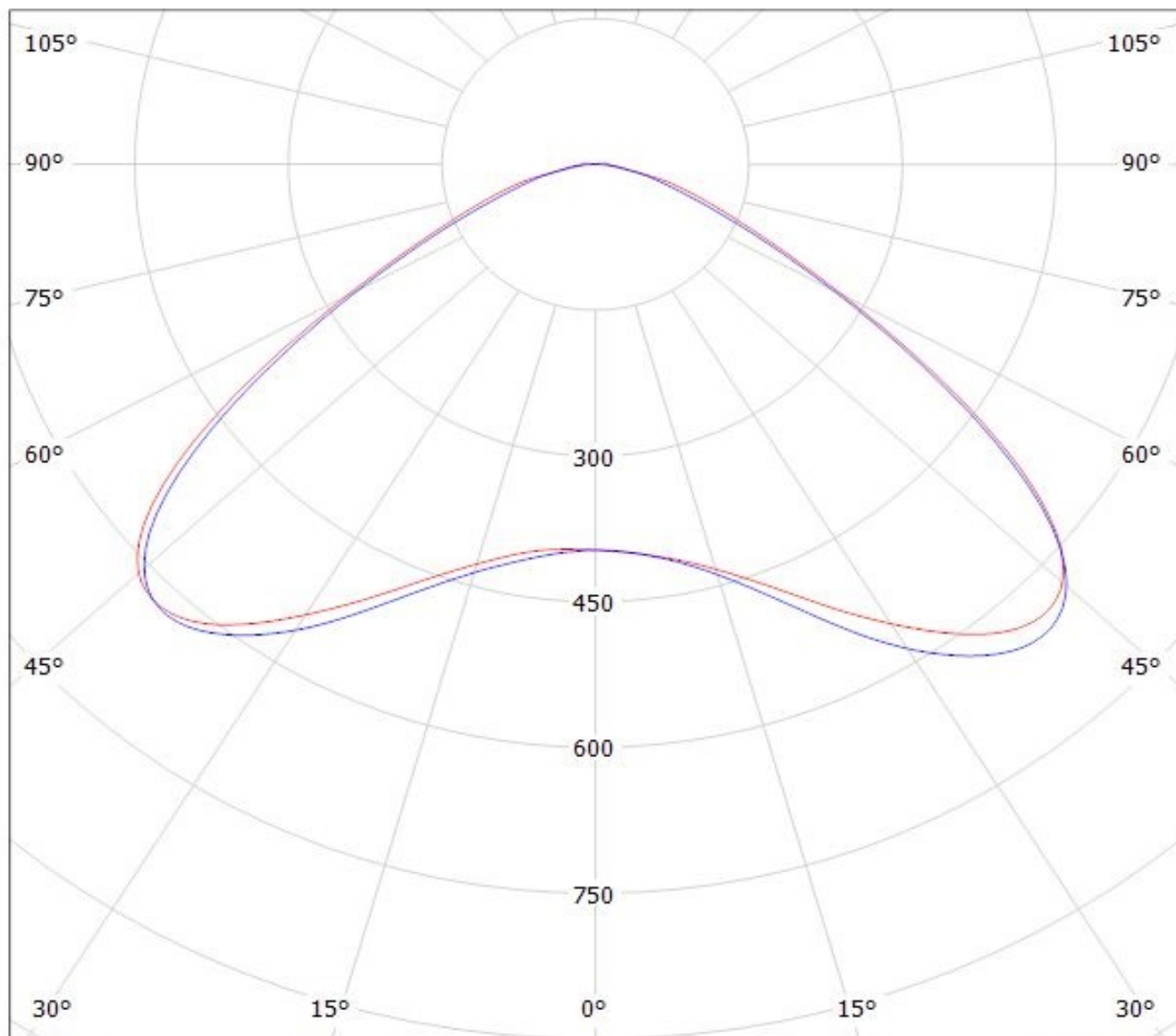

cd/klm

— C0 - C180

— C90 - C270

$\eta = 94\%$

NOTE: The typical divergence will be changed by different color, chip size and chip position tolerance. The typical total divergence is the full angle measured where the luminous intensity is half of the peak value.