

SOMDIMM-LPC2478

Users Manual

For use with
Touch Screen LCD Kit

Copyright ©2009, Future Designs, Inc., All Rights Reserved

FDI ***Future Designs, Inc.***
Your Development Partner
2702 Triana Boulevard SW, Huntsville, AL 35805

Table of Contents

1. Introduction	4
2. LPC2478 SOMDIMM Block Diagram	4
3. Functional Description	5
4. ESD Warning	5
5. Requirements	5
6. SOMDIMM-LPC2478 Power Requirements	5
7. Setting up the Hardware	6
8. Demonstration Software Main Menu	7
9. PC to Demonstration Network Configuration	8
10. Setting up a Slideshow	10
11. Board Layout	11
12. DK-TS-KIT System Functional Block Diagram	12
13. I/O Connector Descriptions	13
JTAG Connector – J3	13
MicroSD Connector – J2	14
ISP Connector – J5	14
14. On Board Functions	15
Ethernet PHY – U8	15
MicroSD – J2	15
Reset Generator – U3	15
Serial EEPROM – U2	15
15. 200-pin SOMDIMM Connector Details – J4	16
16. SOMDIMM Installation	19
17. SOMDIMM Socket Details	19
18. Mechanical Details	20
19. Software	21
20. Configuring Rowley CrossWorks CrossStudio for ARM® for J-Link Flashing	23
21. Functional Test Software	24
Configuring the Functional Test setup	24
Running Functional Test	24
Installing the Demonstration Software via Flash Magic	25
22. Schematics	26
23. Table of Figures	26

Information in this document is provided solely to enable the use of Future Designs products. FDI assumes no liability whatsoever, including infringement of any patent or copyright. FDI reserves the right to make changes to these specifications at any time, without notice. No part of this document may be reproduced or transmitted in any form or by any means, electronic or mechanical, for any purpose, without the express written permission of Future Designs, Inc. 2702 Triana Blvd, Huntsville, AL 35805.

For more information on FDI or our products please visit www.teamfdi.com.

NOTE: The inclusion of vendor software products in this kit does not imply an endorsement of the product by Future Designs, Inc.
© 2009 Future Designs, Inc. All rights reserved.

uEZ™ is a registered trademark of Future Designs, Inc.

Microsoft, MS-DOS, Windows, Windows XP, Microsoft Word are registered trademarks of Microsoft Corporation.

Other brand names are trademarks or registered trademarks of their respective owners.

FDI PN: MA00012

Revision: 3, 12/15/2009 4:38:00 PM

Printed in the United States of America

1. Introduction

The SOMDIMM-LPC2478 provides a quick and easy solution for implementing an ARM7TDMI-S based design by providing the basic functions necessary for a product on an easy to use SOMDIMM. The SOMDIMM uses an industry standard 200 pin SO-DIMM interface. These sockets are utilized by virtually every laptop on the market.

This SOMDIMM is compatible with FDI’s Family of Touch Screen LCD Kits but can also be used for custom platform development or customer applications.

2. LPC2478 SOMDIMM Block Diagram

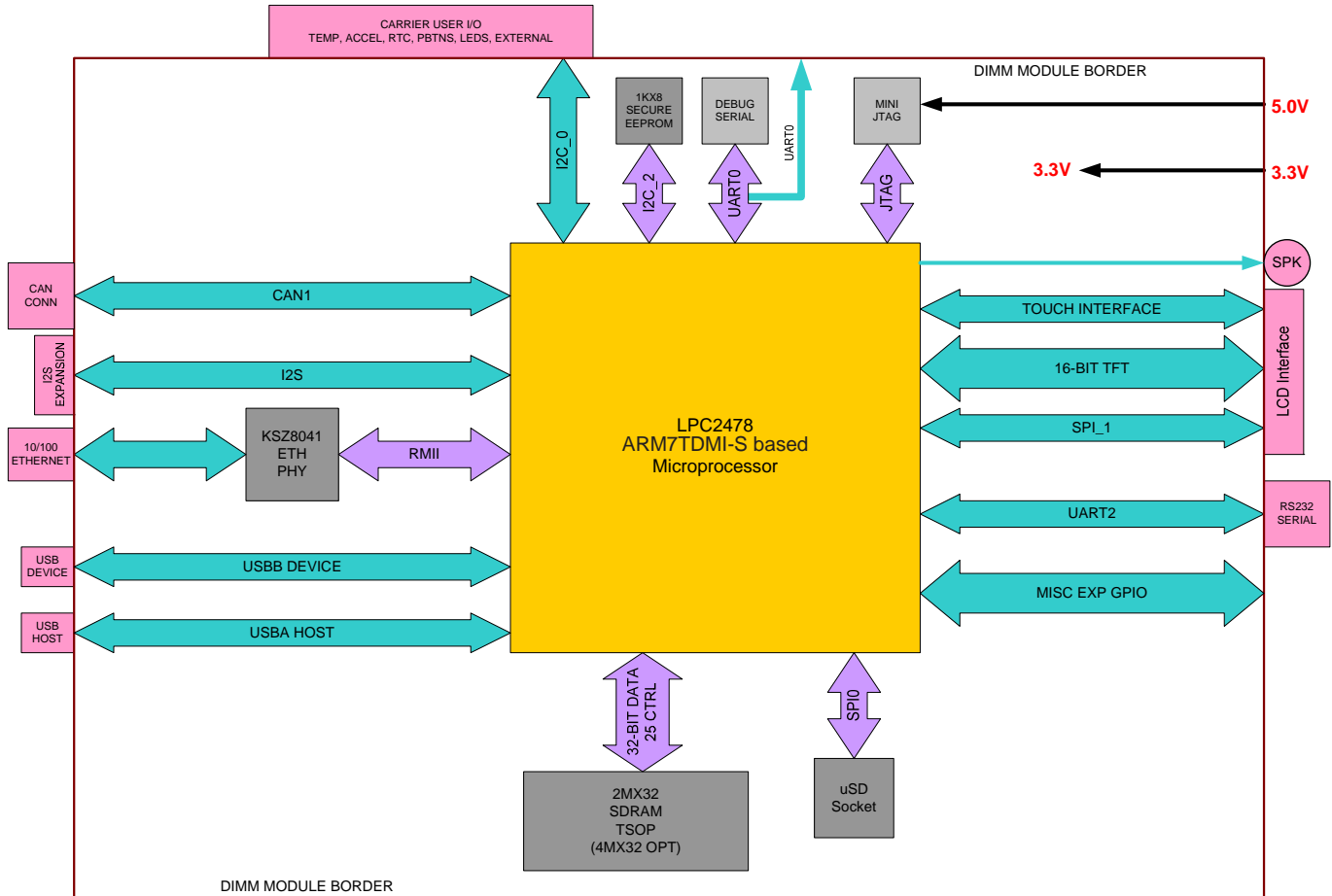

Figure 1 – LPC2478 SOMDIMM Block Diagram

3. Functional Description

SOMDIMM-LPC2478

- LPC2478 ARM7TDMI-S based Microprocessor
- 2Mx32 SDRAM (8Mega-bytes) optional up to 32Mx32
- 1KB I2C-Serial EEPROM with Access Protection
- 10/100 Ethernet PHY
- Micro SD Card Socket for up to 2Giga-bytes storage (SDHC is not supported)
- Mini JTAG
- ISP Connector for use with USP-ICP-LPC2K
- Power-on Reset Generator

4. ESD Warning

The DK-TS-KIT shipped in a protective anti-static package. The kit must not be subjected to high electrostatic potentials. Damage may occur to the boards that will not be covered under warranty. General practice for working with static sensitive devices should be followed when working with the DK-TS-KIT.

5. Requirements

The SOMDIMM-LPC2478 requires a carrier board with a 200-pin SO-DIMM socket. The socket should have the key at the 1.8V location (the SOMDIMM-LPC2478 doesn't require 1.8V). The CARRIER Board from Future Designs provides this socket and should be utilized to develop your application for initial verification.

Example SO-DIMM Socket Manufacturer and Part Number: TYCO 1473005-4

Please refer to section 10 for the pin out details of the SOMDIMM Edge Finger.

6. SOMDIMM-LPC2478 Power Requirements

The following power requirements were measured at room temperature at 72MHz operating clock rate:

Voltage	Booted at the uEZ Demo Screen	Observed Max
3.3V	200mA	208mA

7. Setting up the Hardware

The following are step by step instructions for setting up the hardware.

- 1) Make sure you have a SOMDIMM-LPC2478 board plugged into the CARRIER board at J1.
- 2) Verify the LCD Interface ribbon cable connects the CARRIER board to the LCD CARRIER (J7) board.
- 3) With the power off, plug the 5V center-positive Power Supply into 5V (P5) of the CARRIER board.
- 4) Connect an RJ-45 Ethernet cable to the ETHERNET (J5) interface of the CARRIER board.
- 5) Plug in a female-to-female DB9 serial cable (included in the DK-TS-KIT) between PC and RS232 (P4)
- 6) Insert a flash media drive with the demonstration files (included) into USB HOST (P1).
- 7) If available, plug in a Mini-USB cable to USB DEVICE (P6).
- 8) If available, plug in a CAN DB9 cable into CAN (P3).
- 9) Turn on the power. The title screen should appear and a short tune is played. The main menu will appear.
- 10) After connecting all of the above, your configuration should look as follows:



8. Demonstration Software Main Menu

The Demonstration Software has the following options:

- **Slideshow**
Loads up to nine slides from the flash drive and allows the user to scroll up and down through the material. Slide back to the load screen to return to the main menu. See **Setting up a Slideshow** for details on how to customize.
- **Draw**
A very simple art program is provided. Use the touch screen to draw lines in the box to the right. Click on **Color** to rotate through a list of color choices. **Save** stores the graphic image as the file IMAGE.RAW on the USB Flash drive. **Load** recalls the saved graphic image from the USB Flash drive.
- **Console**
Presents an output screen showing what a remote user sees when Telnetting into the console. On a Windows PC, configure the PC as explained in **PC to Demonstration Network Configuration**, then open a CMD window and type “telnet 192.168.10.20” to connect to the DK-TS-KIT. Type “dir” to show the contents of the Flash drive that is plugged into the DK-TS-KIT. Type “quit” to disconnect.
- **Time & Temperature**
Displays the current time and date from the external Real Time Clock (RTC) and the temperature from the LM75 temperature sensor on the CARRIER board.
- **Accelerometer**
Demonstrates the accelerometer by moving a simulated ball across the screen as the CARRIER board is tilted along the X and Y axis.
- **Settings**
Displays the submenu screen.
- **Calibrate**
Calibrates the Touch Screen and stores the new calibration information in the EEPROM on the SOMDIMM.
- **Functional Test**
Provides a step by step test of all basic features of the DK-TS-KIT. Requires additional hardware to test all features. See **Functional Test Software** section for more details.
- **FCT Loopback**
Puts the unit into a mode that will communicate with another DK-TS-KIT running the **Functional Test**. See **Functional Test Software** section for more details.

9. PC to Demonstration Network Configuration

In order to communicate via Ethernet to the DK-TS-KIT, the PC's network configuration will need to be changed. The simplest method is to give the PC another IP number and add the PC to another subnet. If using Windows XP, follow these instructions. Other operating systems should have similar operations.

Start by going to the **Control Panel** and select **Network Connections**. Then double click the **Local Area Connection** (or similarly named) and click **Properties**. The following dialog should appear. Scroll down to "Internet Protocol (TCP/IP)", select, and then click **Properties**.

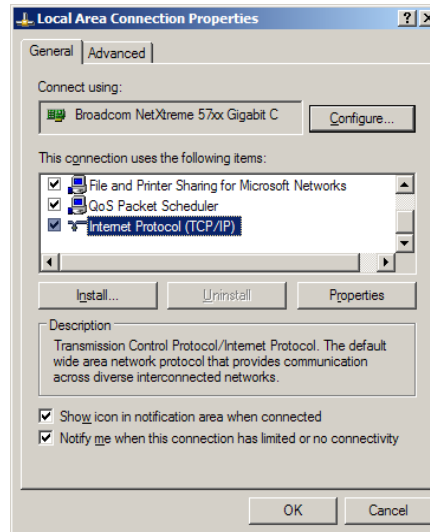

On the next screen, the computer needs to be set to a static IP number. Enter the current IP address, subnet mask, default gateway, and DNS servers (enter the command "ipconfig /all" at a CMD window to get this information). Then click **Advanced** and then click **Add...** and enter the following information and then click **Add**. Click **OK**. Click **OK**.

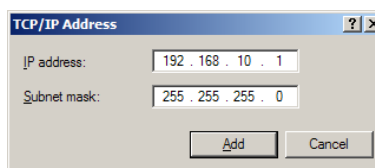

Open another CMD window and type the command “ping 192.168.10.20” and should output the following:

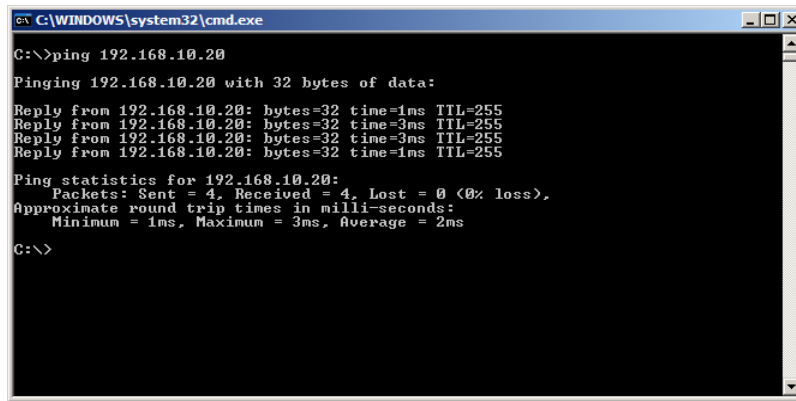

```
C:\WINDOWS\system32\cmd.exe
C:\>ping 192.168.10.20
Pinging 192.168.10.20 with 32 bytes of data:
Reply from 192.168.10.20: bytes=32 time=1ms TTL=255
Reply from 192.168.10.20: bytes=32 time=3ms TTL=255
Reply from 192.168.10.20: bytes=32 time=3ms TTL=255
Reply from 192.168.10.20: bytes=32 time=1ms TTL=255
Ping statistics for 192.168.10.20:
    Packets: Sent = 4, Received = 4, Lost = 0 (0% loss),
    Approximate round trip times in milli-seconds:
        Minimum = 1ms, Maximum = 3ms, Average = 2ms
C:\>
```

Open a browser and go to <http://192.168.10.20> and watch the output. It should appear as follows:

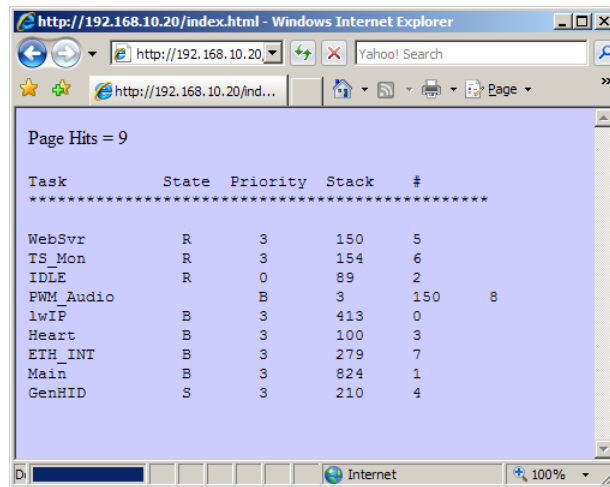

States are: R = Running, B = Blocked, S = Suspended, D = Deleted

NOTE: Blocked means the task is waiting for an event and has a timeout specified, Suspended means it also waiting but has no timeout.

The Stack value is the stack watermark representing the lowest amount of stack left in 32-bit words. For example, in your screenshot, the WebSvr task has always had $150 * 4 = 600$ bytes (or more) available in its stack.

is the task control block number in FreeRTOS. In short, it is the unique number for an active task.

10. Setting up a Slideshow

The Slideshow demonstration loads and scrolls between images provided on a USB Flash drive. Images must be in 24 bit uncompressed Targa (.TGA) format. Adobe Photoshop and many other graphics programs can save images in this format.

When using DK-TS-KIT's with a QVGA LCD (e.g. DK-57TS-LPC2478 or DK-35TS-LPC2478), the images must be 320x240 in size and use the file names QSLIDE01.TGA, QSLIDE02.TGA, QSLIDE03.TGA, etc. QVGA LCD units can also use the older style file names: PICTURE1, PICTURE2, PICTURE3, etc. There is a limit of 38 slides in a slideshow.

When using DK-TS-KIT's with a VGA LCD (e.g. DK-57VTS-LPC2478), the images must be 640x480 in size and use the file names VSLIDE01.TGA, VSLIDE02.TGA, VSLIDE03.TGA, etc. For best results, always use caps in the filename. There is a limit of 8 slides in a VGA slideshow.

11. Board Layout

The following figures illustrate the layout of the various components of the DK-TS-KIT. They are for reference only and are subject to change.

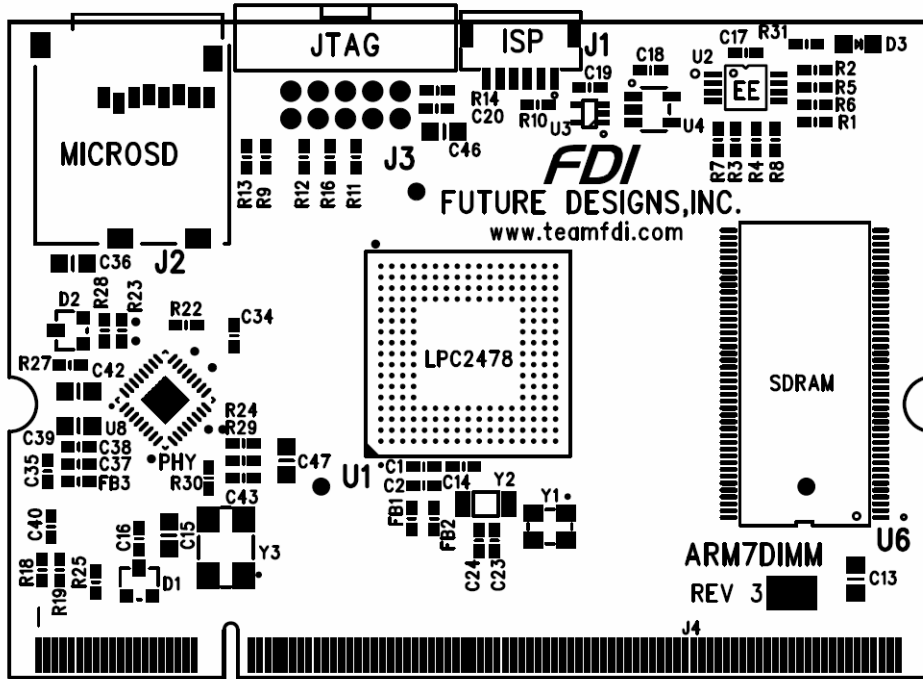

Figure 2 – SOMDIMM-LPC2478 Top Side

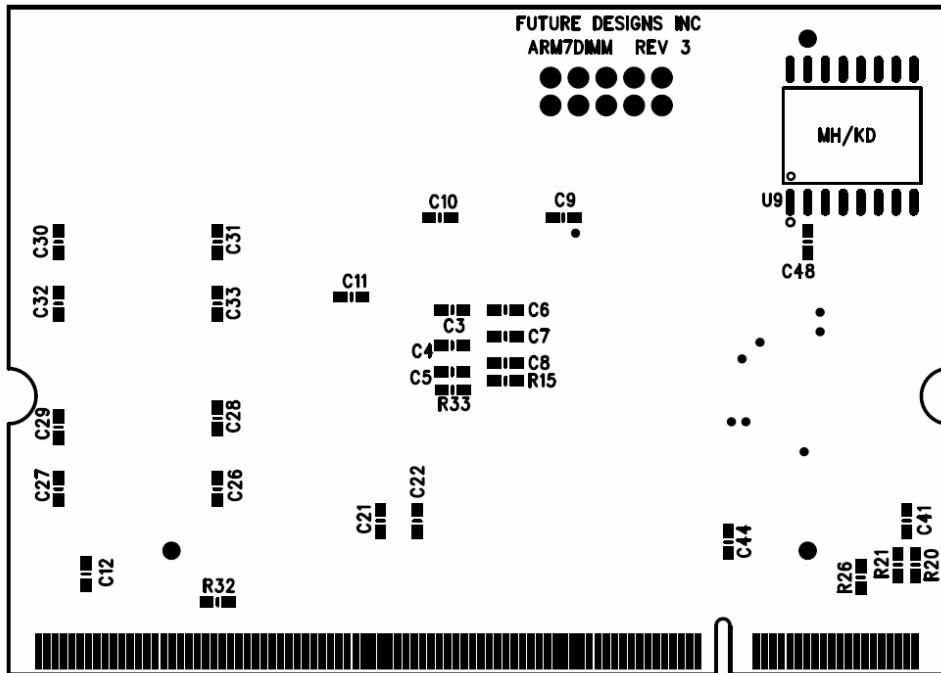

Figure 3 – SOMDIMM-LPC2478 Bottom Side

12. DK-TS-KIT System Functional Block Diagram

The DK-TS-KIT Block Diagram is illustrated below. (5.7" VGA shown)

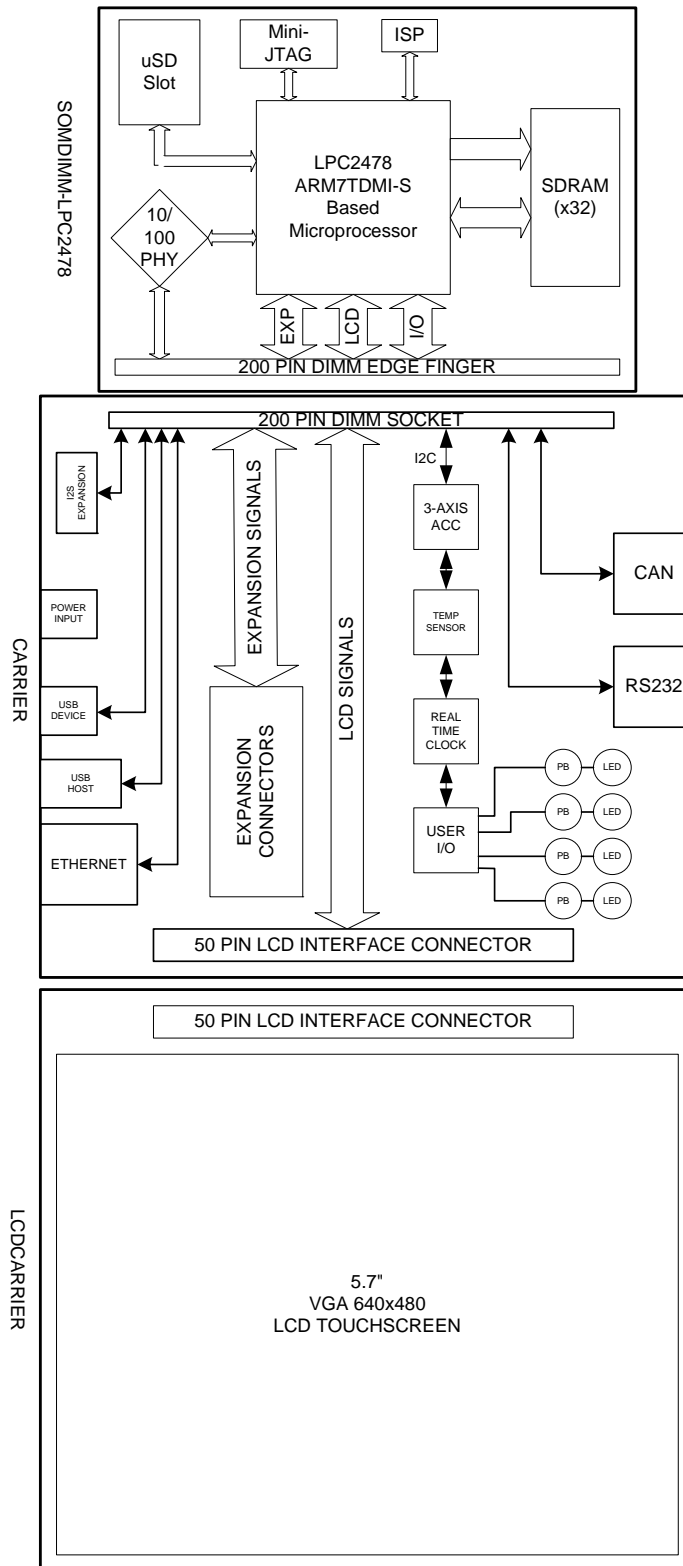

Figure 4 – DK-TS-KIT System Block Diagram

13. I/O Connector Descriptions

JTAG Connector – J3

The SOMDIMM-LPC2478 uses a new, reduced size JTAG connector based on a 2mm Header. This smaller connector provides 100% of the functionality of the standard 20-pin JTAG connector, but utilizes 70% less board space. The connector is a standard part available from most major vendors.

Pin Number	Description
1	3.3V
2	TRSTn
3	TDI
4	TMS
5	TCK
6	RTCK
7	TDO
8	Reset
9	Ground
10	5.0V

For users that may have existing JTAG debuggers, an adapter may be fabricated using the following wiring diagram: (part numbers for the connectors are included from both the manufacturer and Digi-key)

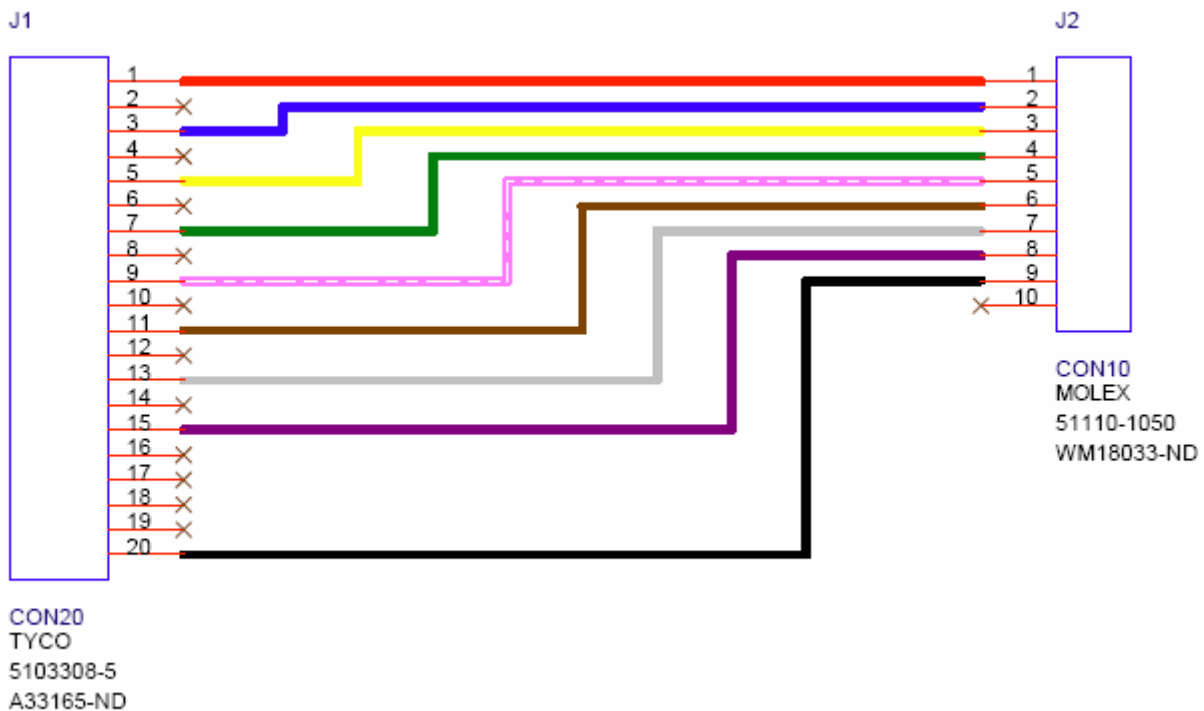

Figure 5 – Mini JTAG Adapter Wiring Diagram

MicroSD Connector – J2

The SOMDIMM-LPC2478 utilizes a MicroSD Socket for flexible mass storage capability. MicroSD Flash Cards are utilized by almost every cell phone on the market and are very cost effective, providing as much as 2GB of user-changeable memory storage. Adapter cards are available (and are usually included with the MicroSD) to facilitate installation of the MicroSD card into a standard SD reader. At this time, the SOMDIMM-LPC2478 uEZ™ software does not support SDHC MicroSD Cards.

Pin Number	Description
1	NC
2	Micro SD Chip Select
3	Micro SD MOSI
4	3.3V
5	Micro SD SCLK
6	Ground
7	Micro SD MISO
8	NC

ISP Connector – J5

The SOMDIMM-LPC2478 includes an ISP programming header that is designed to be utilized with the USB-ICP-LPC2K programmer from Future Designs. This connector is a 1.5mm JST Male, shrouded connector. The JST Part Number is: SM06B-SHLS-TF. The pin out shown below is a direct, 1:1 connection to the USB-ICP-LPC2K programmer available from Future Designs, Digi-Key or Mouser. This ISP programmer may also be included in some, but not all, DK-TS-KITS.

Pin Number	Description
1	3.3V
2	Reset Input
3	ISP Entry
4	Ground
5	RXD
6	TXD

14. On Board Functions

Ethernet PHY – U8

The SOMDIMM-LPC2478 provides an Ethernet PHY from Micrel, KSZ8041NL. The KSZ8041NL is a single chip solution for a 100BASE-TX/10BASE-T physical layer transceiver. It has support for media independent interface (MII), reduced MII (RMII), and HP MDI/MDI-X auto crossover. This allows for any standard Ethernet cable to be used, even a crossover cable. The KSZ8041NL is fully compliant to IEEE 802.3u with support for auto-negotiation and manual selection of 10/100Mbps speed as well as full and half-duplex modes.

For detailed information, please refer to the specific data sheet for this device available from the manufacturer.

MicroSD – J2

The SOMDIMM-LPC2478 provides a MicroSD interface for access to a removable Flash memory. Micro Secure Digital cards are one of the lowest prices per capacity memory cards available. They allow the LPC2478 to have access to a much larger amount of Flash memory in a very small form factor. When using a MicroSD card it can be accessed via the SPI0 bus of the LPC2478. At this time, SDHC MicroSD Cards are not supported by the uEZ™ software.

Reset Generator – U3

The SOMDIMM-LPC2478 utilizes a TPS3801 power-on reset supervisor and voltage monitor. The TPS3801 includes an external reset input that is connected to the reset button on the CARRIER Board.

For detailed information, please refer to the specific data sheet for this device available from the manufacturer.

Serial EEPROM – U2

The SOMDIMM-LPC2478 includes a serial EEPROM, NXP PCA24S08. This device provides 1K-Byte of serial electrically erasable and programmable Read-only memory (EEPROM). Data is received and transmitted via the serial I2C bus. Access permissions limiting reads or writes can be set via the I2C-bus to isolate blocks of memory from improper access.

PCA24S08 Device I2C Bus 2 Address = 0xA8

For detailed information, please refer to the specific data sheet for this device available from the manufacturer.

15. 200-pin SOMDIMM Connector Details – J4

Pin	SOMDIMM Signal Name	Application Details	I/O	SOMDIMM Connection Details
1	ETH_TXP	Ethernet Transmit Positive	O	Output from KSZ8041 Ethernet PHY
2	ETH_RXP	Ethernet Receive Positive	I	Output from KSZ8041 Ethernet PHY
3	ETH_TXN	Ethernet Transmit Negative	O	Input to KSZ8041 Ethernet PHY
4	ETH_RXN	Ethernet Receive Negative	I	Input to KSZ8041 Ethernet PHY
5	3V3A	3.3V Analog	P	Analog 3.3V Output from PHY Circuit
6	GND	Ground	P	
7	ETH_LED0	Ethernet LED0	O	Ethernet LED0 output from KSZ8041
8	ETH_LED1	Ethernet LED1	O	Ethernet LED1 output from KSZ8041
9	VBAT_IN	Vdd Battery Input	P	Vdd for battery backup of internal RTC
10	ALARM	Alarm Signal From Micro	O	
11	RESET_IN	Reset Input	I	Reset input to POR IC TPS3801
12	RESET_OUT	Reset Output from POR	O	Reset output from POR circuit
13	NC	Not connected	U	
14	NC	Not connected	U	
15	NC	Not connected	U	
16	NC	Not connected	U	
17	NC	Not connected	U	
18	NC	Not connected	U	
19	NC	Not connected	U	
20	NC	Not connected	U	
21	VDDA	Vdd Analog	I	ADC Power Supply
22	VREF	Reference Voltage	I	ADC Reference Voltage Input
23	VSSA	Vss Analog	I	ADC Ground
24	GND	Ground	P	
25	GPIO25_LCDPWR	LCD Power Enable	O	Connected to LPC2478 Port 2 bit 0
26	GPIO26_LCDLE	LCD Latch Enable	O	Connected to LPC2478 Port 2 bit 1
27	GPIO27_LCDCLK	LCD Clock	O	Connected to LPC2478 Port 2 bit 2
28	GPIO28_LCDFP		O	Connected to LPC2478 Port 2 bit 3
29	GPIO29_LCDENAB		O	Connected to LPC2478 Port 2 bit 4
30	GPIO30_LCDLP		O	Connected to LPC2478 Port 2 bit 5
31	GPIO31_LCDVD4	LCD Data Bit 4	O	Connected to LPC2478 Port 2 bit 6
32	GPIO32_LCDVD5	LCD Data Bit 5	O	Connected to LPC2478 Port 2 bit 7
33	GPIO33_LCDVD6	LCD Data Bit 6	O	Connected to LPC2478 Port 2 bit 8
34	GPIO34_LCDVD7	LCD Data Bit 7	O	Connected to LPC2478 Port 2 bit 9
35	GPIO35	GPIO	U	Connected to LPC2478 Port 2 bit 10
36	GPIO36	GPIO	U	Connected to LPC2478 Port 2 bit 11
37	3.3V	3.3V Power	P	
38	GND	Ground	P	
39	3.3V	3.3V Power	P	
40	GND	Ground	P	
41	USBH_DP	USB Host Data Positive	B	Connected to LPC2478 USB Port A D+
42	USBD_DP	USB Device Data Positive	B	Connected to LPC2478 USB Port B D+
43	USBH_DM	USB Host Data Negative	B	Connected to LPC2478 USB Port A D-
44	USBD_DM	USB Device Data Negative	B	Connected to LPC2478 USB Port B D-
45	GPIO45_LCDVD18	LCD Data Bit 18	O	Connected to LPC2478 Port 2 bit 12
46	GPIO46_LCDVD19	LCD Data Bit 19	O	Connected to LPC2478 Port 2 bit 13
47	GPIO47_RD	GPIO / CAN Receive Data	I	Connected to LPC2478 Port 0 bit 0
48	GPIO48_TD	GPIO / CAN Transmit Data	O	Connected to LPC2478 Port 0 bit 1
49	GPIO49	GPIO	B	Connected to LPC2478 Port 0 bit 2
50	GPIO50	GPIO	B	Connected to LPC2478 Port 0 bit 3
51	GPIO51_I2SRX_CLK	GPIO / I2S Receive Clock	O	Connected to LPC2478 Port 0 bit 4
52	GPIO52_I2SRX_WS	GPIO / I2S Receive Write Sel	O	Connected to LPC2478 Port 0 bit 5
53	GPIO53_I2SRX_SDA	GPIO / I2S Receive Data	I	Connected to LPC2478 Port 0 bit 6
54	GPIO54_I2STX_CLK	GPIO / I2S Transmit Clock	O	Connected to LPC2478 Port 0 bit 7
55	GPIO55_I2STX_WS	GPIO / I2S Transmit Write Sel	O	Connected to LPC2478 Port 0 bit 8
56	GPIO56_I2STX_SDA	GPIO / I2S Transmit Data	B	Connected to LPC2478 Port 0 bit 9
57	GPIO57_TXD	GPIO / Serial Transmit Data	O	Connected to LPC2478 Port 0 bit 10
58	GPIO58_RXD	GPIO / Serial Receive Data	I	Connected to LPC2478 Port 0 bit 11
59	GPIO59_USBH_PWRD	GPIO / USB Host Power Detect	I	Connected to LPC2478 Port 0 bit 12
60	GPIO60_USBD_UPLD	GPIO / USB Device Up LED	O	Connected to LPC2478 Port 0 bit 13
61	GPIO61_USBD_CON	GPIO / USB Device Connect	O	Connected to LPC2478 Port 0 bit 14
62	GPIO62_SCK	GPIO / SPI Clock	O	Connected to LPC2478 Port 0 bit 15
63	GPIO63	GPIO	O	Connected to LPC2478 Port 0 bit 16 (used for EEPROM CS)
64	GPIO64_MISO	GPIO / SPI MISO	I	Connected to LPC2478 Port 0 bit 17
65	GPIO65_MOSI	GPIO / SPI MOSI	O	Connected to LPC2478 Port 0 bit 18

66	GPIO66_ESDA	GPIO / External I2C SDA	B	Connected to LPC2478 Port 0 bit 19
67	GPIO67_ESCL	GPIO / External I2C SCL	I	Connected to LPC2478 Port 0 bit 20
68	GPIO68_USBH_OVC	GPIO / USB Host Over Current	I	Connected to LPC2478 Port 0 bit 21
69	GPIO69_TPIRQ	GPIO / Touch IC IRQ Input	I	Connected to LPC2478 Port 0 bit 22
70	GPIO70_AD0.0	GPIO / AD0 Bit 0	I	Connected to LPC2478 Port 0 bit 23
71	GPIO71_AD0.1	GPIO / AD0 Bit 1	I	Connected to LPC2478 Port 0 bit 24
72	GPIO72_AD0.2	GPIO / AD0 Bit 2	I	Connected to LPC2478 Port 0 bit 25
73	GPIO73_AD0.3	GPIO / AD0 Bit 3	I	Connected to LPC2478 Port 0 bit 26
74	GPIO74_SDA	GPIO / User IO I2C Bus SDA	B	Connected to LPC2478 Port 0 bit 27
75	GPIO75_SCL	GPIO / User IO I2C Bus SCL	O	Connected to LPC2478 Port 0 bit 28
76	GND	Ground	P	
77	GND	Ground	P	
78	GPIO78_ACC_IRQ	GPIO / Accelerometer IRQ	I	Connected to LPC2478 Port 1 bit 2
79	GPIO79	GPIO	U	Connected to LPC2478 Port 1 bit 3
80	GPIO80_RTC_IRQ	GPIO / RTC IRQ Input	I	Connected to LPC2478 Port 1 bit 5
81	GPIO81	Not connected	U	Connected to LPC2478 Port 1 bit 6
82	GPIO82	Not connected	U	Connected to LPC2478 Port 1 bit 7
83	GPIO83	Not connected	U	Connected to LPC2478 Port 1 bit 11
84	GPIO84	Not connected	U	Connected to LPC2478 Port 1 bit 12
85	GPIO85	Not connected	U	Connected to LPC2478 Port 1 bit 13
86	GPIO86_LED_BR	GPIO / LED Backlight Bright	O	Connected to LPC2478 Port 1 bit 18
87	GPIO87_USBH_PPWR	GPIO / USB Host Power Ctl	O	Connected to LPC2478 Port 1 bit 19
88	GPIO88_LCDVD10	LCD Data Bit 10	O	Connected to LPC2478 Port 1 bit 20
89	GPIO89_LCDVD11	LCD Data Bit 11	O	Connected to LPC2478 Port 1 bit 21
90	GPIO90_LCDVD12	LCD Data Bit 12	O	Connected to LPC2478 Port 1 bit 22
91	GPIO91_LCDVD13	LCD Data Bit 13	O	Connected to LPC2478 Port 1 bit 23
92	GPIO92_LCDVD14	LCD Data Bit 14	O	Connected to LPC2478 Port 1 bit 24
93	GPIO93_LCDVD15	LCD Data Bit 15	O	Connected to LPC2478 Port 1 bit 25
94	GPIO94_LCDVD20	LCD Data Bit 16	O	Connected to LPC2478 Port 1 bit 26
95	GPIO95_LCDVD21	LCD Data Bit 17	O	Connected to LPC2478 Port 1 bit 27
96	GPIO96_LCDVD22	LCD Data Bit 22	O	Connected to LPC2478 Port 1 bit 28
97	GPIO97_LCDVD23	LCD Data Bit 23	O	Connected to LPC2478 Port 1 bit 29
98	GPIO98_USBD_VBUS	USB Device VBus Sense Input	I	Connected to LPC2478 Port 1 bit 30
99	GPIO99_AD0.5	GPIO or AD0.5	I	Connected to LPC2478 Port 1 bit 31
100	NC	Not connected	B	Unused
101	GND	Ground	P	
102	GND	Ground	P	
103	NC	Not connected	U	Unused
104	NC	Not connected	U	Unused
105	NC	Not connected	U	Unused
106	NC	Not connected	U	Unused
107	NC	Not connected	U	Unused
108	NC	Not connected	U	Unused
109	NC	Not connected	U	Unused
110	NC	Not connected	U	Unused
111	NC	Not connected	U	Unused
112	NC	Not connected	U	Unused
113	5V0	5.0V Power	P	
114	5V0	5.0V Power	P	
115	NC	Not connected	U	Unused
116	GPIO116	GPIO	B	Connected to LPC2478 Port 2 bit 14
117	GPIO117	GPIO	B	Connected to LPC2478 Port 2 bit 15
118	GPIO118	GPIO	B	Connected to LPC2478 Port 2 bit 19
119	GPIO119	GPIO	B	Connected to LPC2478 Port 2 bit 21
120	GPIO120	GPIO	B	Connected to LPC2478 Port 2 bit 22
121	GPIO121	GPIO	B	Connected to LPC2478 Port 2 bit 23
122	GPIO122	GPIO	B	Connected to LPC2478 Port 2 bit 25
123	GPIO123_SPKR	GPIO	O	Connected to LPC2478 Port 2 bit 26
124	GPIO124	GPIO	B	Connected to LPC2478 Port 2 bit 27
125	NC	Not connected	U	
126	NC	Not connected	U	
127	GPIO127_LCDVD2	LCD Data Bit 2	O	Connected to LPC2478 Port 4 bit 28
128	GPIO128_LCDVD3	LCD Data Bit 3	O	Connected to LPC2478 Port 4 bit 29
129	GND	Ground	P	
130	GND	Ground	P	
131	NC	Not connected	U	Unused
132	NC	Not connected	U	Unused
133	NC	Not connected	U	Unused
134	NC	Not connected	U	Unused

135	NC	Not connected	U	Unused
136	NC	Not connected	U	Unused
137	NC	Not connected	U	Unused
138	NC	Not connected	U	Unused
139	NC	Not connected	U	Unused
140	NC	Not connected	U	Unused
141	NC	Not connected	U	Unused
142	NC	Not connected	U	Unused
143	NC	Not connected	U	Unused
144	NC	Not connected	U	Unused
145	NC	Not connected	U	Unused
146	NC	Not connected	U	Unused
147	NC	Not connected	U	Unused
148	NC	Not connected	U	Unused
149	NC	Not connected	U	Unused
150	NC	Not connected	U	Unused
151	NC	Not connected	U	Unused
152	NC	Not connected	U	Unused
153	NC	Not connected	U	Unused
154	NC	Not connected	U	Unused
155	NC	Not connected	U	Unused
156	NC	Not connected	U	Unused
157	NC	Not connected	U	Unused
158	NC	Not connected	U	Unused
159	NC	Not connected	U	Unused
160	NC	Not connected	U	Unused
161	NC	Not connected	U	Unused
162	NC	Not connected	U	Unused
163	GND	Ground	P	
164	GND	Ground	P	
165	3.3V	3.3V Power	P	
166	GND	Ground	P	
167	NC	Not connected	U	Unused
168	NC	Not connected	U	Unused
169	NC	Not connected	U	Unused
170	NC	Not connected	U	Unused
171	NC	Not connected	U	Unused
172	NC	Not connected	U	Unused
173	NC	Not connected	U	Unused
174	NC	Not connected	U	Unused
175	NC	Not connected	U	Unused
176	NC	Not connected	U	Unused
177	NC	Not connected	U	Unused
178	NC	Not connected	U	Unused
179	NC	Not connected	U	Unused
180	NC	Not connected	U	Unused
181	NC	Not connected	U	Unused
182	NC	Not connected	U	Unused
183	NC	Not connected	U	Unused
184	NC	Not connected	U	Unused
185	NC	Not connected	U	Unused
186	NC	Not connected	U	Unused
187	NC	Not connected	U	Unused
188	NC	Not connected	U	Unused
189	NC	Not connected	U	Unused
190	NC	Not connected	U	Unused
191	NC	Not connected	U	Unused
192	NC	Not connected	U	Unused
193	NC	Not connected	U	Unused
194	NC	Not connected	U	Unused
195	NC	Not connected	U	Unused
196	NC	Not connected	U	Unused
197	NC	Not connected	U	Unused
198	NC	Not connected	U	Unused
199	3.3V	3.3V Power	P	
200	GND	Ground	P	

16. SOMDIMM Installation

The SOMDIMM-LPC2478 should be inserted into the DIMM Socket as shown below and then locked into place by pushing down to the Carrier Board. Ensure the SOMDIMM is inserted completely into the socket prior to locking. The socket utilized on the CARRIER Board is rated for a minimum of 25 insertions.

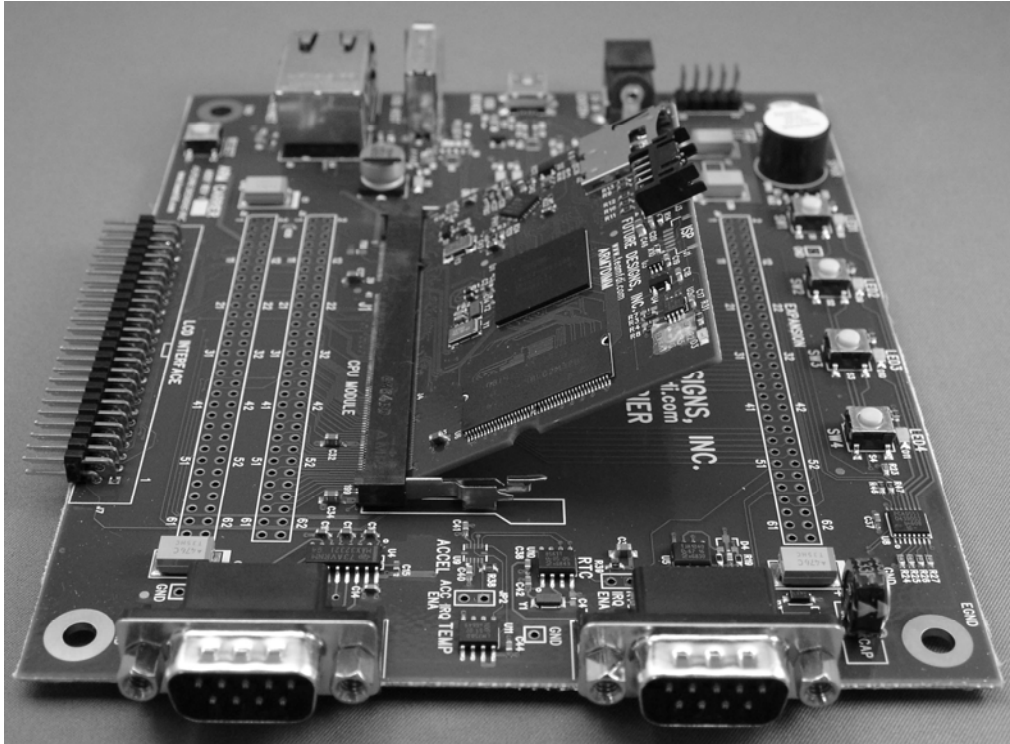

Figure 6 – SOMDIMM Insertion

17. SOMDIMM Socket Details

The SOMDIMM-LPC2478 is designed to be used with a standard 200-pin DDR2 SO-DIMM Socket connector. An example connector part is as follows: Mfg: Tyco (AMP), Part Number: 1473005-5.

18. Mechanical Details

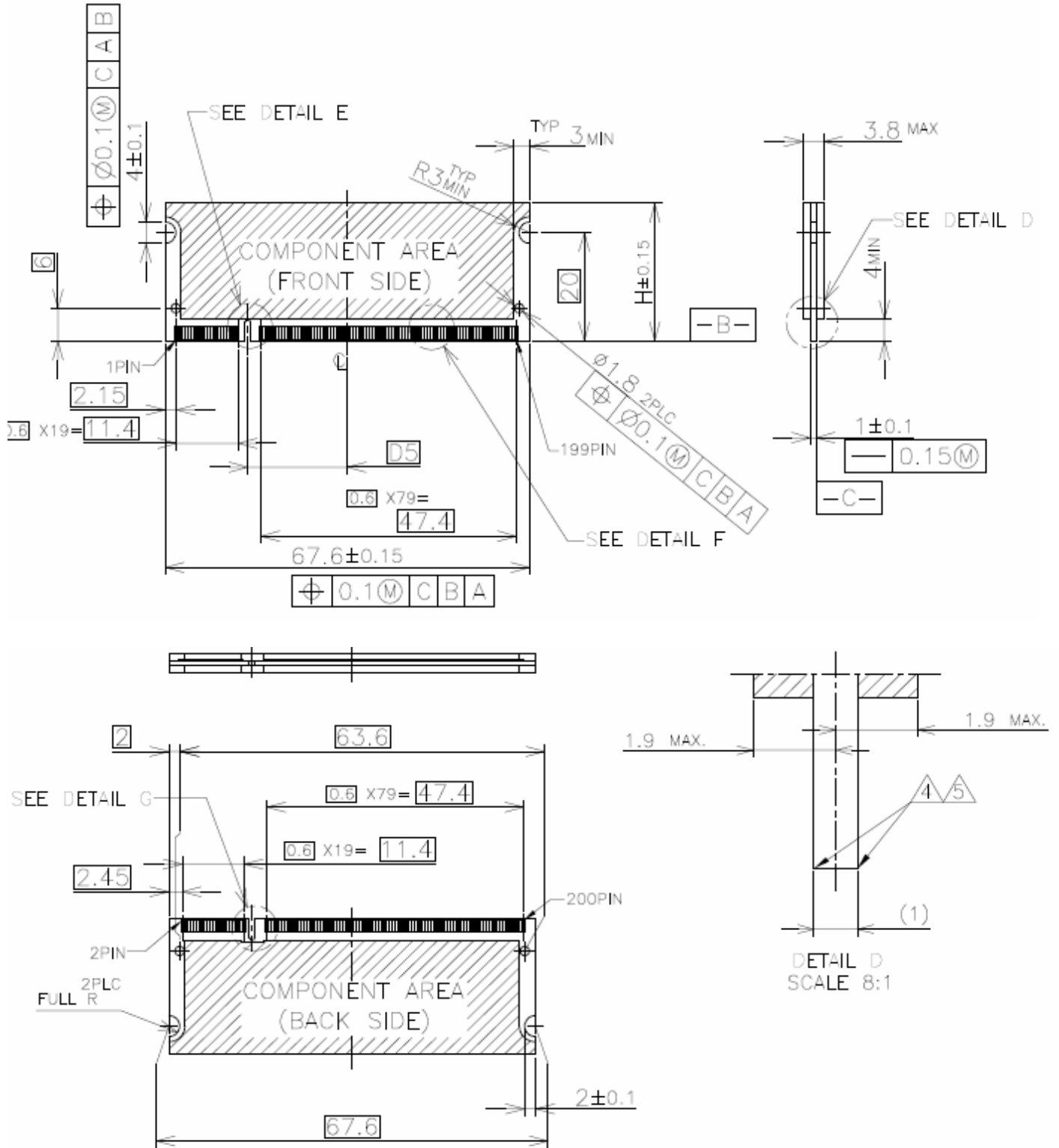

Figure 7 – SODIMM-LPC2478 Mechanical Details

19. Software

μ EZ™ takes its name from the Muses of Greek mythology. A Muse was a goddess who inspired the creation process for the arts and sciences. Like its ancient Greek namesake, the μ EZ™ platform inspires rapid development by supplying customers with an extensive library of open source software, drivers, and processor support - all under a common framework. μ EZ™ development works on the premise of "design once, reuse many times". This provides an open source standard for embedded developers to build upon and support. μ EZ™ allows companies to focus on innovation and on their own value-added applications while minimizing development time and maximizing software reuse.

The diagram below shows a typical embedded application stack. μ EZ™ has three primary categories of components that help simplify embedded application development:

1. **Operating System Abstraction Layer (μ EZ™ OSAL)**
2. **Sub-system drivers (μ EZ™ TCP/IP, μ EZ™ USB, μ EZ™ Driver)**
3. **Hardware Abstraction Layer (μ EZ™ HAL)**

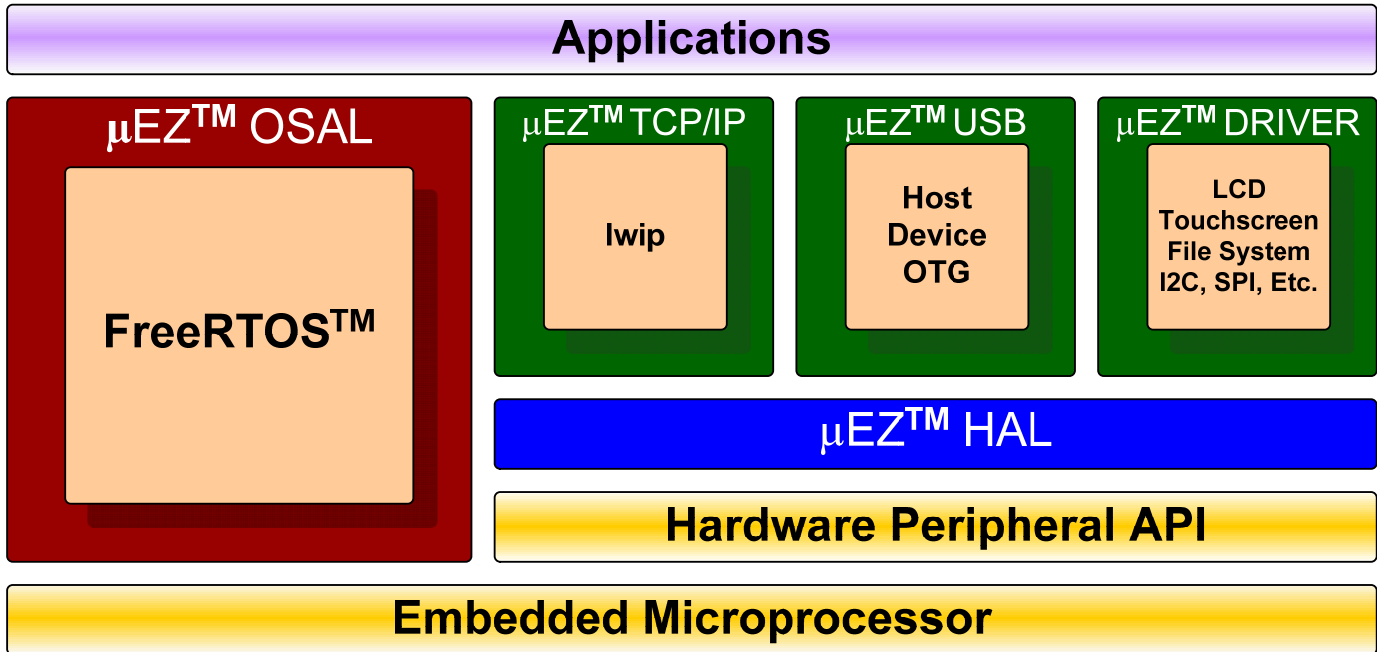

The selection of an RTOS can be one of the most daunting aspects of an embedded system development. With μ EZ™ the primary features of common multi-tasking operating systems are abstracted, thus easing the transition to an open source or low-cost RTOS. The μ EZ™ OSAL provides applications access to the following features in an OS-independent fashion:

- Pre-emptive multitasking
- Stack overflow detection
- Unlimited number of tasks
- Queues
- Semaphores (binary, counting, mutex)

The **μEZ™** sub-system drivers utilize the OSAL functions to provide protected access to the processor peripherals. The sub-system driver API functions are typically protocol layer interfaces (TCP/IP, USB, etc) designed as high-level access routines such as open, close, read, write, etc. where possible.

The HAL functions provide single-threaded unprotected access to the processor peripherals. Customers can use the **μEZ™** HAL routines provided by FDI or they can write their own. The HAL routines provide for RTOS/**μEZ™** independence and allow portability within a family of processors.

μEZ™ is ideally suited for Embedded Systems with standard features such as:

- Processor and Platform BSPs
(Board Support Packages)
- Real Time Operating System (RTOS)
- Memory Management
- NAND/NOR Flash
- SDRAM and DDR Memory
- TCP/IP stack
- USB Device/Host Libraries
- Mass Storage Devices
- LCD Displays with Touch Screen
- Input / Output Devices

20. Configuring Rowley CrossWorks CrossStudio for ARM® for J-Link Flashing

- 1) See the document “uEZ™ Software Quickstart Guide” for details on how to download the uEZ™ source code and setup the Rowley CrossWorks compiler.
- 2) Plug in the J-Link device into the PC and install any drivers as directed.
- 3) Plug in the J-Link’s JTAG connector to the SOMDIMM board at J3 with the JTAG adapter.
- 4) Select **Target** menu and choose **Targets**. The following list will appear to the right.

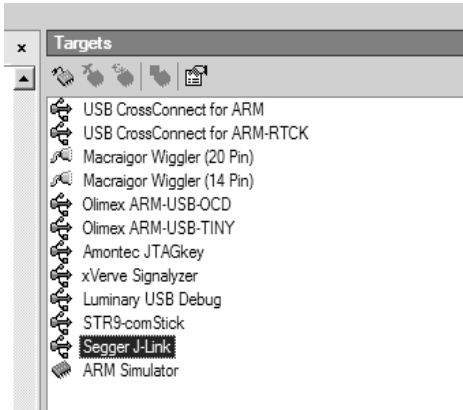

- 5) Right click on “Segger J-Link” and select Properties

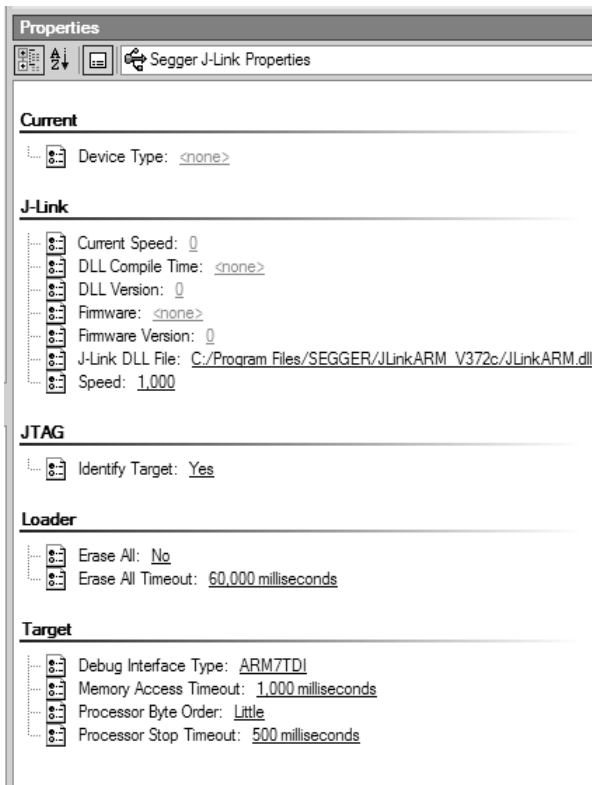

- 6) If programming a blank LPC2478 part, select a Speed of 100. If the part has already been programmed, select a Speed of 1000.
- 7) Go back to menu **Target** and select “Connect Segger J-Link”
- 8) Compile the application and press F5 to download and start debugging.

21. Functional Test Software

The functional test software tests all the features of the DK-TS-KIT. Additional hardware is required to test all the features, but these additional tests can be bypassed if the necessary hardware is not available.

Configuring the Functional Test setup

Another DK-TS-KIT is required for complete functional testing. By connecting to another kit's serial and CAN port, the functional test can receive automatic responses for specific queries. The DK-TS-KIT only needs a version of firmware that has the FCT Loopback program. This document will refer to this second unit as the "loopback unit".

Start with a CARRIER board that is already connected as described above, but disconnect the PC to serial connection. Connect a null modem cable between the CARRIER RS232 port (P4) and the loopback unit's RS232 port (also P4). NOTE: A gender change may be required. Then connect a DB9 cable between the CARRIER CAN port (P3) and loopback unit's CAN port (also P3). Power will be provided to the loopback unit from the CARRIER CAN port. When the loopback unit boots up, select **Settings** and then **FCT Loopback**. You are now ready to do the functional test.

Running Functional Test

From the Main Menu, select Settings and then **Functional Test** to start the test. To abort the functional test, PRESS and HOLD the **Cancel** button. If the current test cannot be performed, press **Skip** to go to the next test. Most tests will run automatically and will report a green "Pass" or red "Fail" output. Some tests will require user input in the form of a question and a **Yes** or **No** response. If a test fails, the functional test will pause to show the error – press **OK** to continue.

The following tests are performed:

- SDRAM – Memory is sized and a basic test is performed to confirm read/write access.
- LCD Colors – Red, Green, and Blue are displayed in smooth bands to ensure the LCD lines are correct.
- External RTC – The CARRIER board has an external NXP I2C PCF8563 Real Time Clock that is set to 1/1/2009, 8:00:00 and then sampled for 3 seconds to verify that it is operational.
- Internal RTC – The LPC2478 has an internal RTC that is programmed to 1/1/2009, 8:00:00 and then sampled for 3 seconds to verify that it is operational.
- EEPROM – The EEPROM is tested for communication and integrity.
- Temperature Sensor – The CARRIER board has an external LM75A that is tested to be in a range of 20-30 C.
- Serial Port – A serial command is sent to the loopback unit and a response detected.
- CAN Port – An 8 byte message is sent via CAN to the loopback unit and a response detected.
- Micro SDCard – A FAT formatted Micro SDCard that is inserted into the SOMDIMM-LPC2478 J2 slot is read to verify that the file TESTSDC.TXT is correct. (SDHC not supported)
- USB Host – A FAT formatted USB Flash drive inserted into the CARRIER board P1 slot is read to verify that the file TESTUSB.TXT is correct.
- Accelerometer – The on board accelerometer detects when the CARRIER board is rotated 90 degrees back (LCD facing towards the back and upside down) and then rotated forward 90 degrees (LCD facing forward and right side up).
- LEDs and Buttons – All four LEDs (LED1 to LED4) on the CARRIER board are lit by pressing the push button switches SW1 to SW4.

- USB Device – The CARRIER board is plugged into a PC via its USB Device port (P6) and acts as a keyboard. Pressing the Caps Lock key twice on the PC will continue the functional test.
- Speaker – Tunes are played and the User is asked to verify that they are heard.
- Ethernet – Waits for a web page hit at <http://192.168.10.20/>

A final report of PASS or FAIL is displayed along with a list of any Skipped and Failed items.

Installing the Demonstration Software via Flash Magic

To upgrade the SOMDIMM-LPC2478 with the latest demonstration software, use the following instructions.

- 1) Plug the SOMDIMM-LPC2478 in an CARRIER board if you have not already done so.
- 2) Connect the 5V power to the CARRIER board at P5 and turn on the AC power.
- 3) Plug a USB-ICP-LPC2K into the PC and attach the adapter cable to J3 of the SOMDIMM-LPC2478.
- 4) Open Flash Magic (version 4.30 or later) and setup as shown.

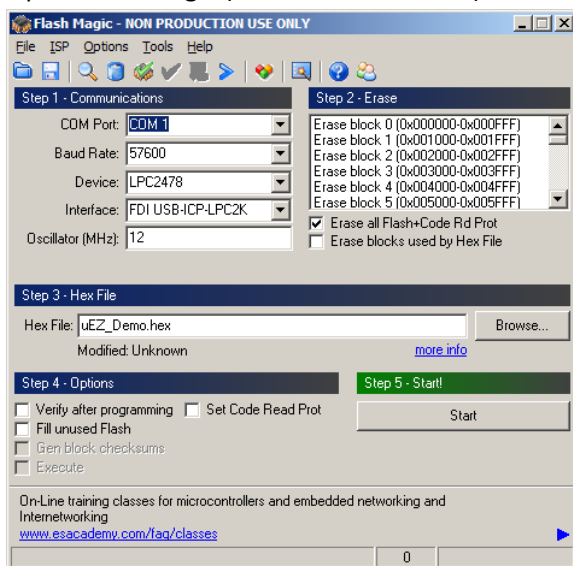

- 5) Select the COM port where the USB-ICP-LPC2K was installed (or check the Device Manager).
- 6) Choose a baud rate of 57600, Device of LPC2478, and Oscillator of 12 MHz.
- 7) Make sure "Erase all Flash+Code Rd Prot" is checked
- 8) Enter the name of the hex file or use **Browse** to select it.
- 9) Leave the rest of the items unchecked
- 10) Click **Start** and wait for the transfer to complete. The board will reset when completed.
- 11) Unplug the USB-ICP-LPC2K from J3 when done.

22. Schematics

Please see the website at:

<http://www.teamfdi.com/SOMDIMM-LPC2478>

23. Table of Figures

Figure 1 – LPC2478 SOMDIMM Block Diagram.....	4
Figure 2 – SOMDIMM-LPC2478 Top Side.....	11
Figure 3 – SOMDIMM-LPC2478 Bottom Side.....	11
Figure 4 – DK-TS-KIT System Block Diagram	12
Figure 5 – Mini JTAG Adapter Wiring Diagram	13
Figure 6 – SOMDIMM Insertion	19
Figure 7 – SOMDIMM-LPC2478 Mechanical Details.....	20