

**600V Cascode GaN FET in PQFN88 (drain tab)**

**Description**

The TPH3206LDG 600V, 150mΩ gallium nitride (GaN) FET is a normally-off device. Transphorm GaN FETs offer better efficiency through lower gate charge, faster switching speeds, and smaller reverse recovery charge, delivering significant advantages over traditional silicon (Si) devices.

Transphorm is a leading-edge wide band gap supplier with world-class innovation and a portfolio of fully-qualified GaN transistors that enables increased performance and reduced overall system size and cost.

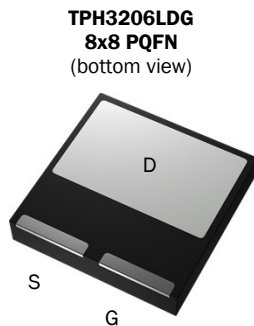
**Related Literature**

- [AN0009](#): Recommended External Circuitry for GaN FETs
- [AN0003](#): Printed Circuit Board Layout and Probing

**Ordering Information**

Part Number*	Package	Package Configuration
TPH3206LDG**	8 x 8mm PQFN	Common Drain

\* Add "-TR" suffix for tape and reel  
 \*\* LDG package offers larger gate pad



**Features**

- Easy to drive—compatible with standard gate drivers
- Low conduction and switching losses
- Low Qrr of 54nC—no free-wheeling diode required
- JEDEC-qualified GaN technology
- RoHS compliant and Halogen-free

**Benefits**

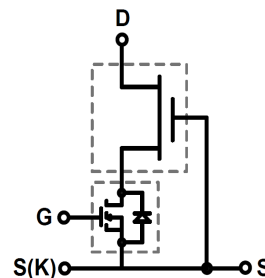
- Increased efficiency through fast switching
- Increased power density
- Reduced system size and weight
- Enables more efficient topologies—easy to implement bridgeless totem-pole designs
- Lower BOM cost

**Applications**

- Renewable energy
- Industrial
- Automotive
- Telecom and datacom
- Servo motors

Key Specifications	
V <sub>DS</sub> (V) min	600
V <sub>TDS</sub> (V) max	750
R <sub>DS(on)</sub> (mΩ) max*	180
Q <sub>rr</sub> (nC) typ	54
Q <sub>g</sub> (nC) typ	6.2

\* Includes dynamic R<sub>(on)</sub>



**Cascode Device Structure**

# TPH3206LDG

## Absolute Maximum Ratings ( $T_C=25^\circ\text{C}$ unless otherwise stated)

Symbol	Parameter	Limit Value	Unit
$I_{D25^\circ\text{C}}$	Continuous drain current @ $T_C=25^\circ\text{C}$ <sup>a</sup>	17	A
$I_{D100^\circ\text{C}}$	Continuous drain current @ $T_C=100^\circ\text{C}$ <sup>a</sup>	12	A
$I_{DM}$	Pulsed drain current (pulse width: 100 $\mu\text{s}$ )	60	A
$V_{DSS}$	Drain to source voltage	600	V
$V_{TDS}$	Transient drain to source voltage <sup>b</sup>	750	V
$V_{GSS}$	Gate to source voltage	$\pm 18$	V
$P_{D25^\circ\text{C}}$	Maximum power dissipation	96	W
$T_C$	Operating temperature	Case	-55 to +150
$T_J$		Junction	-55 to +175
$T_S$	Storage temperature	-55 to +150	$^\circ\text{C}$
$T_{CSOLD}$	Soldering peak temperature <sup>c</sup>	260	$^\circ\text{C}$

## Thermal Resistance

Symbol	Parameter	Typical	Unit
$R_{\theta JC}$	Junction-to-case	1.55	$^\circ\text{C}/\text{W}$
$R_{\theta JA}$	Junction-to-ambient <sup>d</sup>	45	$^\circ\text{C}/\text{W}$

Notes:

- For high current operation, see application note AN0009
- In off-state, spike duty cycle  $D < 0.1$ , spike duration  $< 1\mu\text{s}$
- Reflow MSL3
- Device on one layer epoxy PCB for drain connection (vertical and without air stream cooling, with 6cm<sup>2</sup> copper area and 70 $\mu\text{m}$  thickness)

# TPH3206LDG

## Electrical Characteristics (T<sub>C</sub>=25 °C unless otherwise stated)

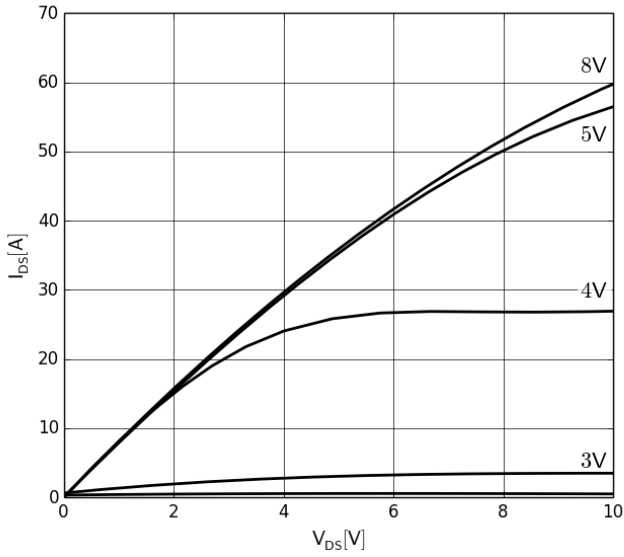
Symbol	Parameter	Min	Typ	Max	Unit	Test Conditions
<b>Static</b>						
V <sub>DSS-MAX</sub>	Maximum drain-source voltage	600	—	—	V	V <sub>GS</sub> =0V
V <sub>GS(th)</sub>	Gate threshold voltage	1.65	2.1	2.6	V	V <sub>DS</sub> =V <sub>GS</sub> , I <sub>D</sub> =500μA
R <sub>DS(on)</sub>	Drain-source on-resistance (T <sub>J</sub> =25 °C)	—	150	180	mΩ	V <sub>GS</sub> =8V, I <sub>D</sub> =11A, T <sub>J</sub> =25 °C
	Drain-source on-resistance (T <sub>J</sub> =175 °C)	—	340	—		V <sub>GS</sub> =8V, I <sub>D</sub> =11A, T <sub>J</sub> =175 °C
I <sub>DSS</sub>	Drain-to-source leakage current (T <sub>J</sub> =25 °C)	—	2.5	90	μA	V <sub>DS</sub> =600V, V <sub>GS</sub> =0V, T <sub>J</sub> =25 °C
	Drain-to-source leakage current (T <sub>J</sub> =150 °C)	—	8	—		V <sub>DS</sub> =600V, V <sub>GS</sub> =0V, T <sub>J</sub> =150 °C
I <sub>GSS</sub>	Drain-to-source forward leakage current	—	—	100	nA	V <sub>GS</sub> =18V
	Drain-to-source reverse leakage current	—	—	-100		V <sub>GS</sub> =-18V
<b>Dynamic</b>						
C <sub>ISS</sub>	Input capacitance	—	760	—	pF	V <sub>GS</sub> =0V, V <sub>DS</sub> =480V, f=1MHz
C <sub>OSS</sub>	Output capacitance	—	44	—		
C <sub>RSS</sub>	Reverse transfer capacitance	—	5	—		
C <sub>O(er)</sub>	Output capacitance, energy related <sup>a</sup>	—	64	—	pF	V <sub>GS</sub> =0V, V <sub>DS</sub> =0V to 480V
C <sub>O(tr)</sub>	Output capacitance, time related <sup>a</sup>	—	105	—		
Q <sub>g</sub>	Total gate charge <sup>b</sup>	—	6.2	9.3	nC	V <sub>DS</sub> =100V <sup>a</sup> , V <sub>GS</sub> =0V to 4.5V, I <sub>D</sub> =11A
Q <sub>gs</sub>	Gate-source charge	—	2.1	—		
Q <sub>gd</sub>	Gate-drain charge	—	2.2	—		
t <sub>d(on)</sub>	Turn-on delay	—	6	—	ns	V <sub>DS</sub> =480V, V <sub>GS</sub> =0V to 10V, I <sub>D</sub> =11A, R <sub>G</sub> =2Ω
t <sub>r</sub>	Rise time	—	4.5	—		
T <sub>d(off)</sub>	Turn-off delay	—	9.7	—		
t <sub>f</sub>	Fall time	—	4	—		
<b>Reverse Operation</b>						
I <sub>S</sub>	Reverse current	—	—	12	A	V <sub>GS</sub> =0V, T <sub>C</sub> =100 °C
V <sub>SD</sub>	Reverse voltage	—	2.2	—	V	V <sub>GS</sub> =0V, I <sub>S</sub> =11A, T <sub>J</sub> =25 °C
		—	3.6	—		V <sub>GS</sub> =0V, I <sub>S</sub> =11A, T <sub>J</sub> =175 °C
		—	1.48	—		V <sub>GS</sub> =0V, I <sub>S</sub> =5.5A, T <sub>J</sub> =25 °C
t <sub>rr</sub>	Reverse recovery time	—	17	—	ns	I <sub>S</sub> =11A, V <sub>DD</sub> =400V, di/dt=2000A/μs, T <sub>J</sub> =25 °C
Q <sub>rr</sub>	Reverse recovery charge	—	54	—	nC	

Notes:

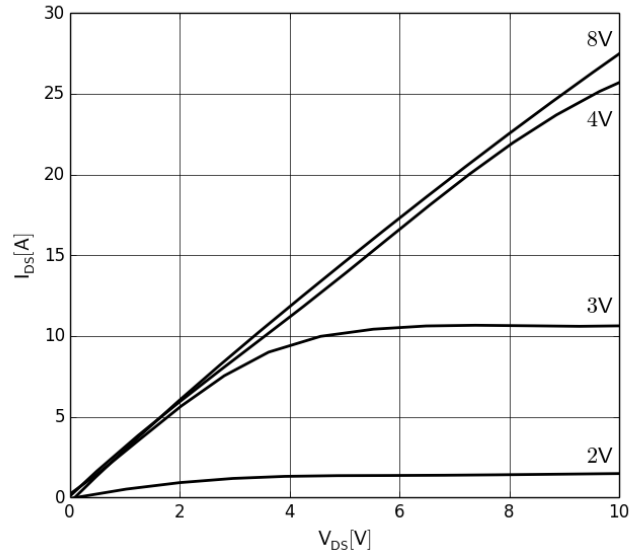
- Fixed while V<sub>DS</sub> is rising from 0 to 80% V<sub>DSS</sub>
- Q<sub>g</sub> does not change for V<sub>DS</sub>>100V

# TPH3206LDG

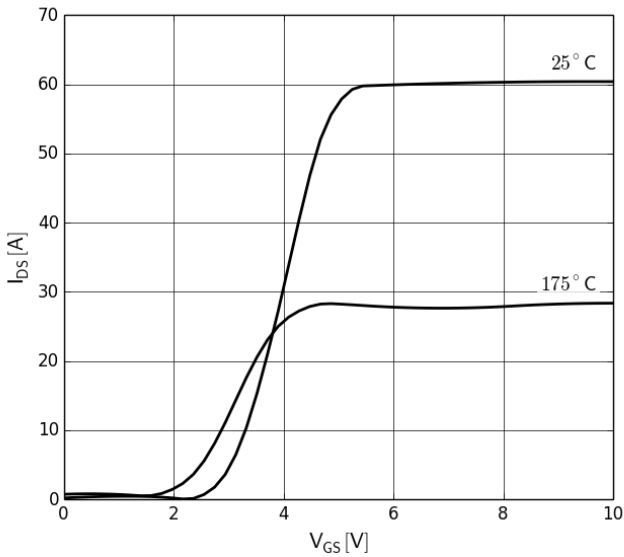
## Typical Characteristics (25 °C unless otherwise stated)



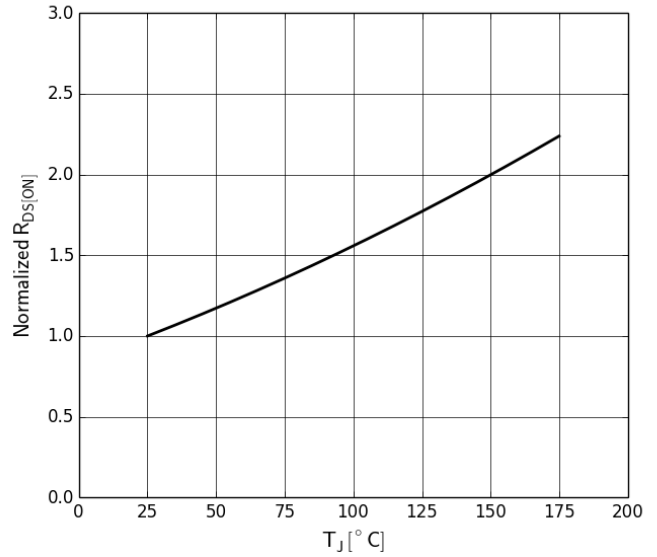
**Figure 1. Typical Output Characteristics  $T_J=25^\circ\text{C}$**   
Parameter:  $V_{GS}$



**Figure 2. Typical Output Characteristics  $T_J=175^\circ\text{C}$**   
Parameter:  $V_{GS}$



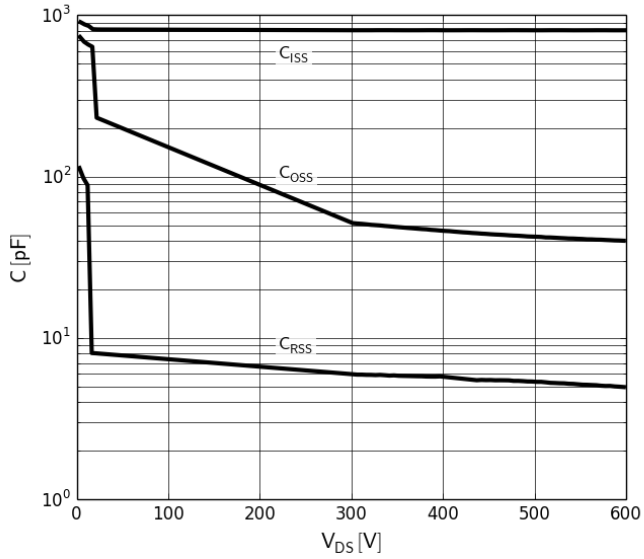
**Figure 3. Typical Transfer Characteristics**  
 $V_{DS}=10\text{V}$ , parameter:  $T_J$



**Figure 4. Normalized On-Resistance**  
 $I_D=12\text{A}$ ,  $V_{GS}=8\text{V}$

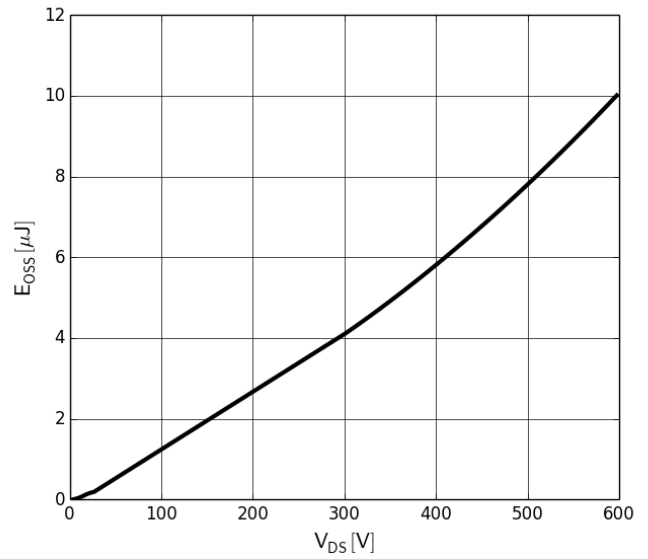
# TPH3206LDG

## Typical Characteristics (25 °C unless otherwise stated)

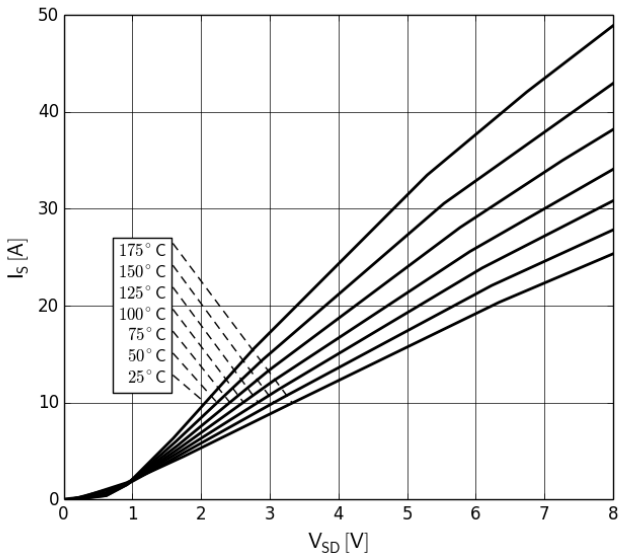


**Figure 5. Typical Capacitance**

$V_{GS}=0V, f=1MHz$

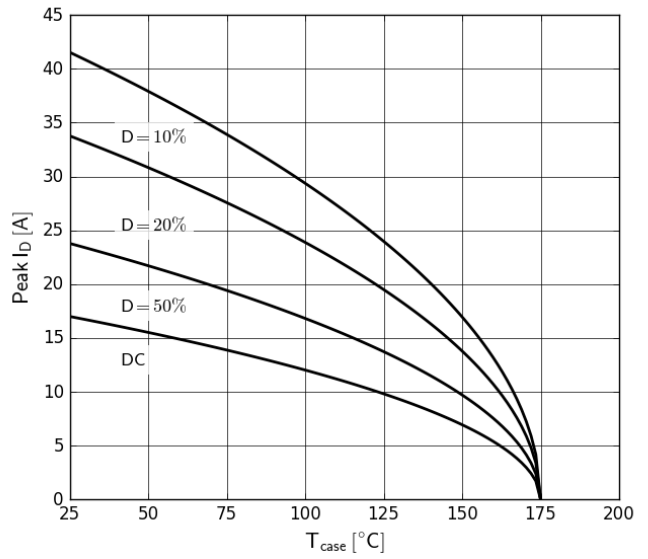


**Figure 6. Typical  $C_{oss}$  Stored Energy**



**Figure 7. Forward Characteristics of Rev. Diode**

$I_s=f(V_{SD}), \text{Parameter } T_j$



**Figure 8. Current Derating**

Pulse width  $\leq 100\mu s$

# TPH3206LDG

## Typical Characteristics (25 °C unless otherwise stated)

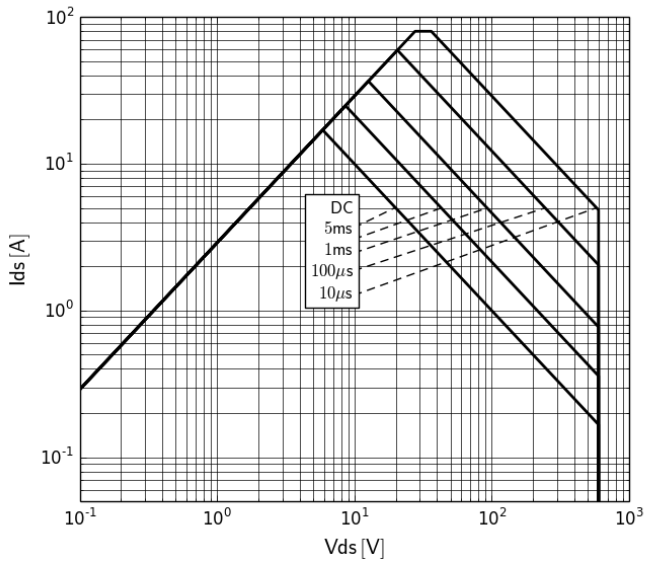


Figure 9. Safe Operating Area  $T_c=25^\circ\text{C}$

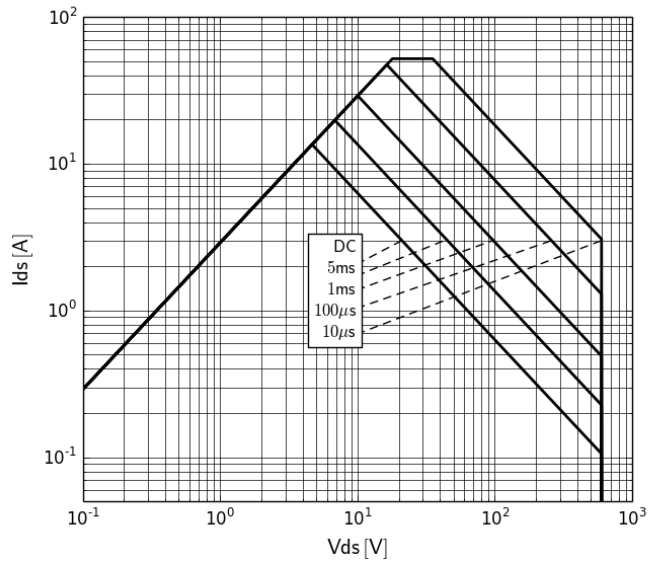


Figure 10. Safe Operating Area  $T_c=80^\circ\text{C}$

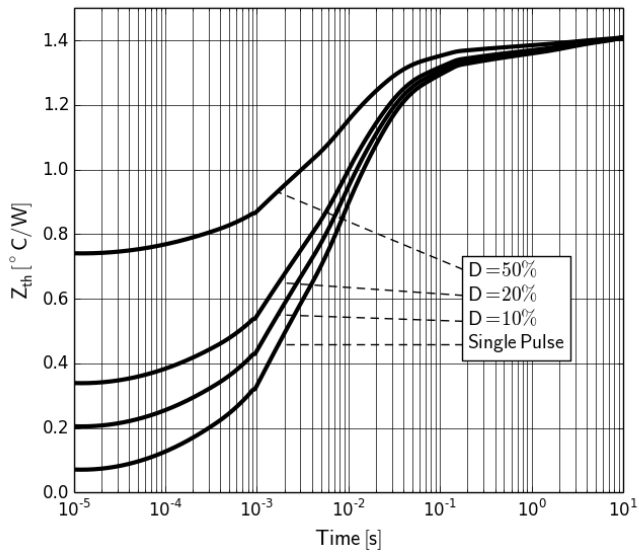


Figure 11. Transient Thermal Resistance

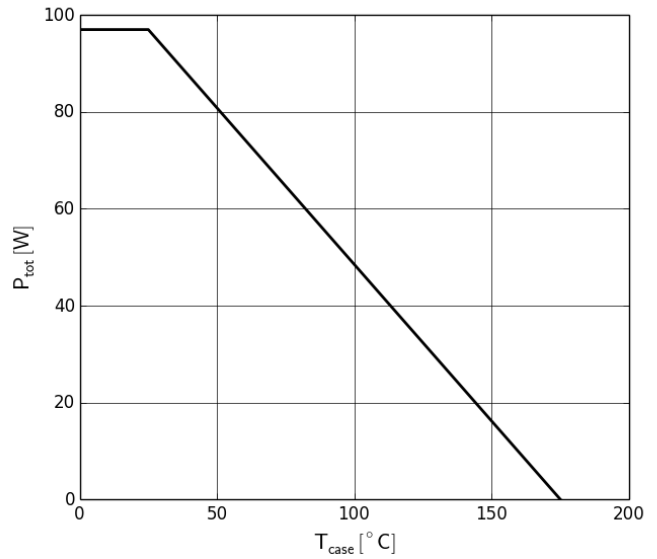
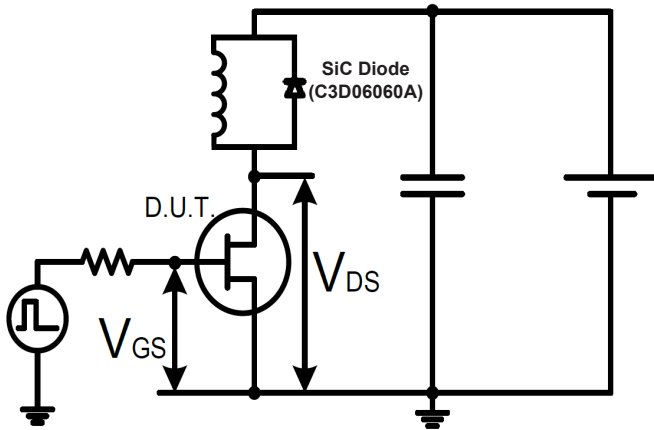


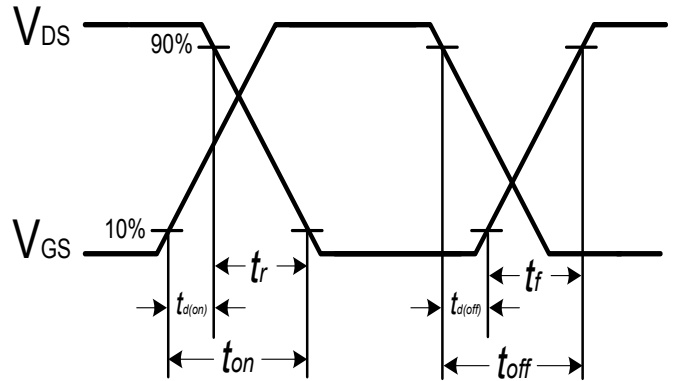
Figure 12. Power Dissipation

# TPH3206LDG

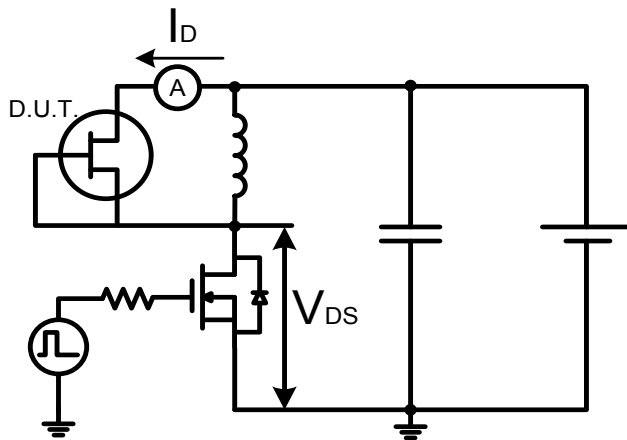
## Test Circuits and Waveforms



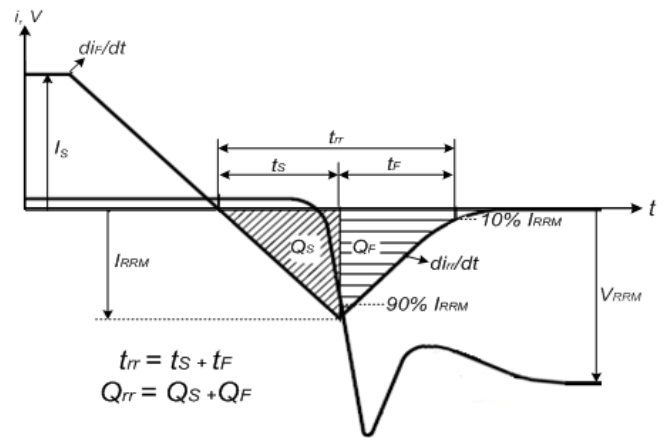
**Figure 13. Switching Time Test Circuit**  
\*See app note AN0009 for methods to ensure clean switching



**Figure 14. Switching Time Waveform**



**Figure 15. Test Circuit for Diode Characteristics**

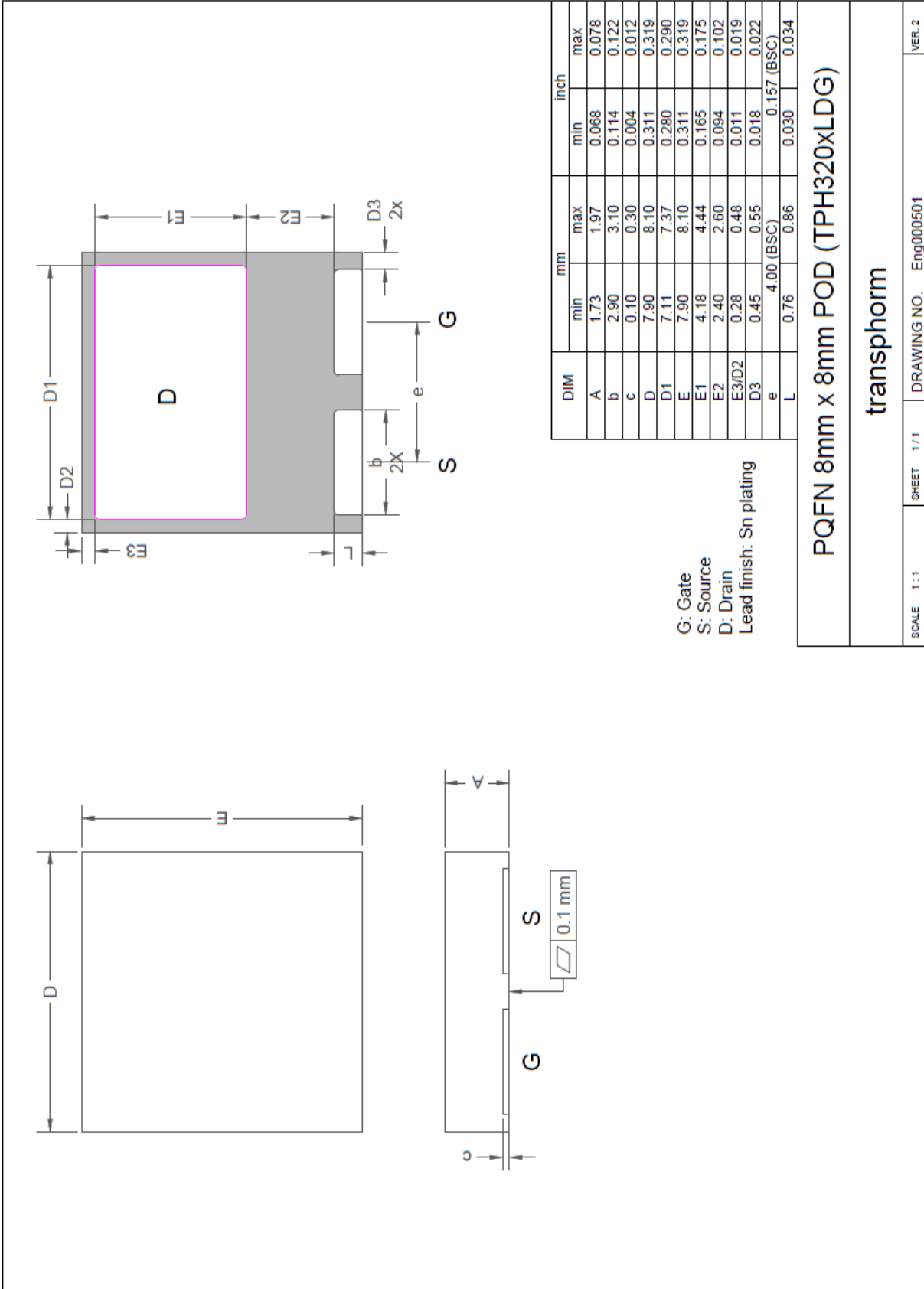


**Figure 16. Diode Recovery Waveform**

# TPH3206LDG

## Mechanical

## 8x8 PQFN (LDG) Package





# TPH3206LDG

## Design Considerations

The fast switching of GaN devices reduces current-voltage cross-over losses and enables high frequency operation while simultaneously achieving high efficiency. However, taking full advantage of the fast switching characteristics of GaN switches requires adherence to specific PCB layout guidelines and probing techniques.

Before evaluating Transphorm GaN devices, see application note [Printed Circuit Board Layout and Probing for GaN Power Switches](#). The table below provides some practical rules that should be followed during the evaluation.

### When Evaluating Transphorm GaN Devices:

DO	DO NOT
Minimize circuit inductance by keeping traces short, both in the drive and power loop	Twist the pins of TO-220 or TO-247 to accommodate GDS board layout
Minimize lead length of TO-220 and TO-247 package when mounting to the PCB	Use long traces in drive circuit, long lead length of the devices
Use shortest sense loop for probing; attach the probe and its ground connection directly to the test points	Use differential mode probe or probe ground clip with long wire
See <a href="#">AN0003</a> : Printed Circuit Board Layout and Probing	

## Application Notes

- [AN0002](#): Characteristics of Transphorm GaN Power Switches
- [AN0003](#): Printed Circuit Board Layout and Probing
- [AN0004](#): Designing Hard-switched Bridges with GaN
- [AN0008](#): Drain Voltage and Avalanche Ratings for GaN FETs
- [AN0009](#): Recommended External Circuitry for GaN FETs

## Evaluation Boards

- TDPS500E2C1-KIT: 1kW totem-pole PFC evaluation platform
- TDPS1000E0E10-KIT: 1kW hard-switched half-bridge, buck, or boost evaluation platform
- TDPV1000E0C1-KIT: 1kW inverter evaluation platform

# TPH3206LDG

---

## Revision History

Version	Date	Change(s)
6	11/14/2016	Added application note AN0009