

SMD Receiver Component

OPL6000

Features:

- Up to 256kbps Operation
- Up to 250klux Ambient Light Immunity
- Output Drive for Interfacing to Microcontroller
- Reverse Gull Wing Design
- Compliant with Smart Power Meter Standard ANSI C12.18
- Compatible with OP181 Emitter Component

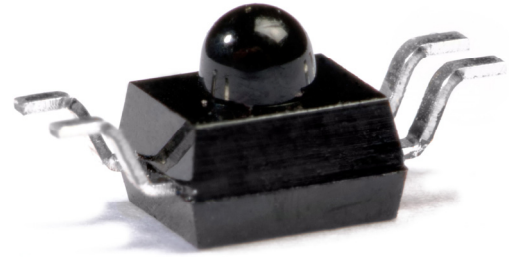

Description:

The **OPL6000** is a surface mount receiver component incorporating a custom CMOS ASIC. The product features a digital output in a push-pull inverter design. The circuitry provides ambient light immunity while maintaining low power consumption. The ASIC is lead frame mounted and overmolded, incorporating a lens to achieve maximum light coupling ability. In addition, the overmold compound provides visible light rejection. While this part has been designed specifically for the smart power meter industry, other applications are certainly possible.

Applications:

- Smart power meter optical port
- Over the air communications

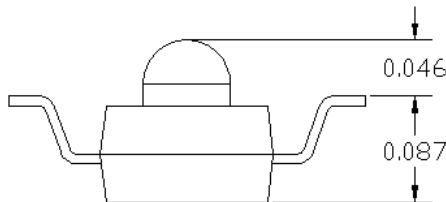
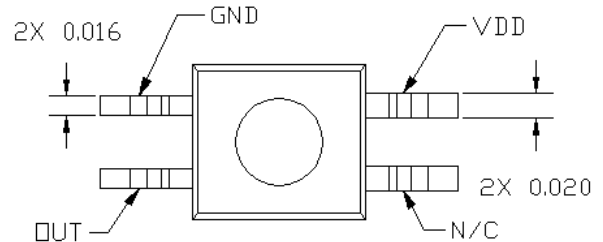
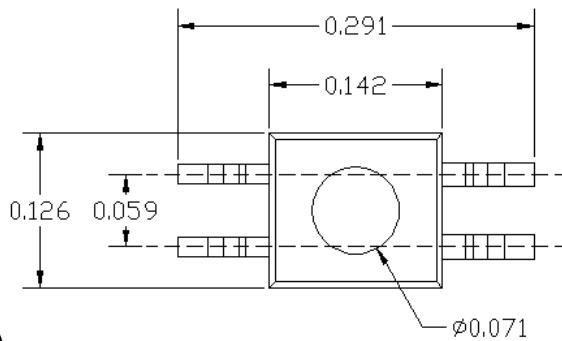
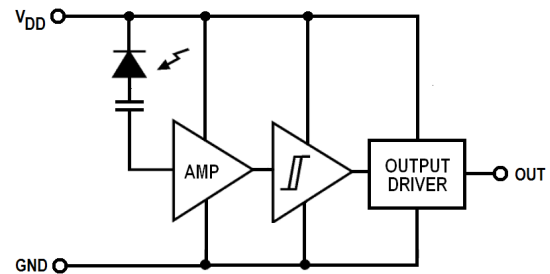

Note: The V_{DD} and N/C leads are the wider of the four leads as indicated above but also have red strip indicator on the bottom of the leads.



ESD
(Human Body Model)



MOISTURE
(Level-4)



Pb-Free
(RoHS)

Dimensions are ± 0.005 unless otherwise specified

General Note

TT Electronics reserves the right to make changes in product specification without notice or liability. All information is subject to TT Electronics' own data and is considered accurate at time of going to print.

Absolute Maximum Ratings ($T_A = 25^\circ\text{C}$ unless otherwise noted)

Overall Product

Storage Temperature Range	-55°C to +100°C
Operating Temperature Range	-40°C to +85°C
D.C. Supply Voltage	3.0 - 5.5 V
Output Drive Current	1 mA
Power Dissipation in Active / Inactive Mode ⁽¹⁾⁽²⁾	30 mW / 5mW ⁽²⁾
Incident Irradiance	250,000 lux
Solder Reflow Temperature ⁽³⁾	260°C

Notes:

- Active mode is defined as the state during which time a signal is being received and the output stages are active. Inactive mode is defined as the state during which time no signal is being received and the output stages are inactive.
- Derate linearly at 0.40 mW/°C (active mode) and 0.067 mW/°C (inactive mode) above 25°C. Solder time less than 5 seconds at temperature extreme.
- Solder time less than 5 seconds at temperature extreme. Solder time within 5° of peak temperature is 20 to 40 seconds.

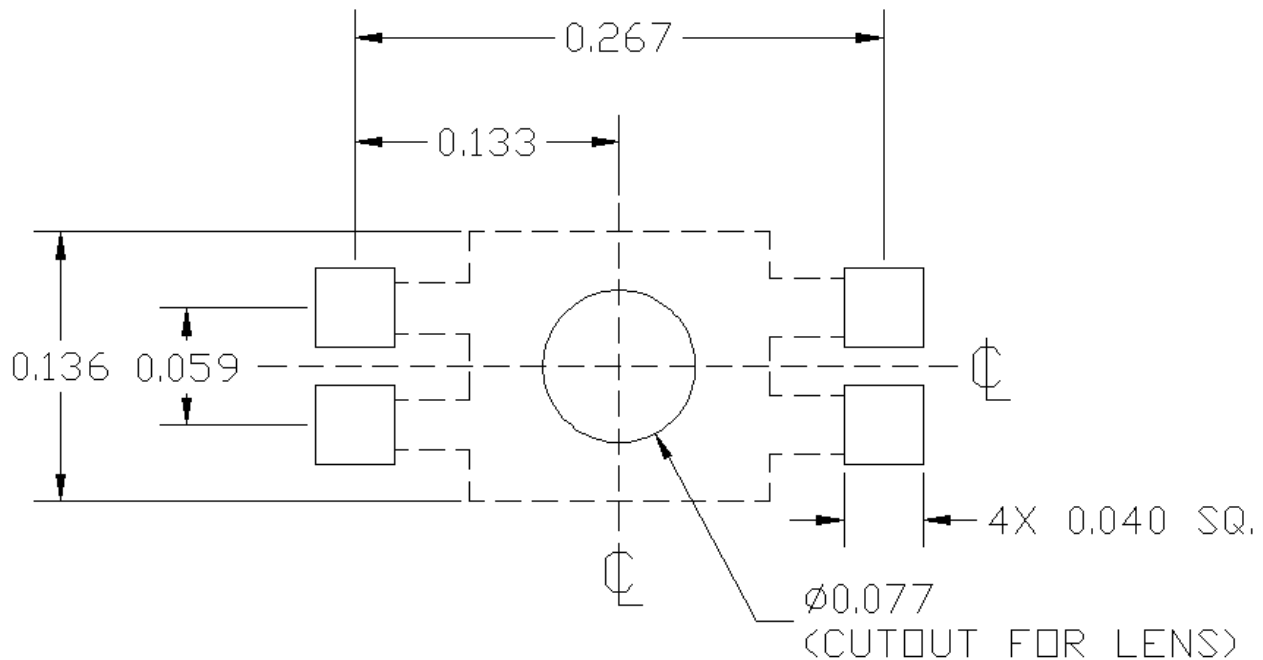
Recommended PCB Layout

General Note

TT Electronics reserves the right to make changes in product specification without notice or liability. All information is subject to TT Electronics' own data and is considered accurate at time of going to print.



1645 Wallace Drive, Carrollton, TX 75006 | Ph: +1 972 323 2200
 www.optekinc.com | www.ttelectronics.com

Electrical Specifications

Electrical Characteristics ($T_A = 25\text{ }^\circ\text{C}$ unless otherwise noted)

SYMBOL	PARAMETER	MIN	TYP	MAX	UNITS	TEST CONDITIONS	
V_{DD}	Operating Supply Voltage	3.0	3.3	5.5	V		
I_{DD}	Supply Current ₍₁₎	Active Mode	-	-	5	mA	$V_{DD} = 3.0$ to 5.5 V No load current
		Inactive Mode	-	-	1.0		
PSRR	Power Supply Rejection Ratio	10	-	-	%	$f = 1 - 1$ MHz, $V_{DD} > 3.0$ V	
$E_{eT(+)}$	Positive Going Threshold Irradiance	-	0.100	0.125	mW/cm ²	$V_{DD} = 3.3$ V $I_p = 940$ nm; collimated radiation	
V_{OL}	Low Level Output Voltage	-	300	400	mV	$V_{DD} = 3.0$ to 5.5 V, $I_o = 1$ mA $E_e = 0$ mW/cm ²	
V_{OH}	High Level Output Voltage	$V_{DD} - 1.0$	-	-	V	$V_{DD} = 3.0$ to 5.5 V, $I_o = 1$ mA $E_e = 7.5$ mW/cm ²	
t_r, t_f	Rise Time, Fall Time	-	-	150	ns	$V_{DD} = 3.3$ V, $f = 1$ kHz $E_e = 7.5$ mW/cm ² Decouple Cap (V_{DD} to GND) = 0.1 μ F	
t_{PDHL}, t_{PDLH}	Propagation Delay	-	-	1.0	μ s		
I_I	Input Leakage Current	-10	-	10	μ A		
I_o	Output Drive Current	-	-	1.0	mA	$V_{DD} = 3.3$ V	

Notes:

- Active mode is defined as the state during which time a signal is being received and the output stages are active.
Inactive mode is defined as the state during which time no signal is being received and the output stages are inactive.

General Note

TT Electronics reserves the right to make changes in product specification without notice or liability. All information is subject to TT Electronics' own data and is considered accurate at time of going to print.



1645 Wallace Drive, Carrollton, TX 75006 | Ph: +1 972 323 2200
www.optekinc.com | www.ttelectronics.com

Supply Current

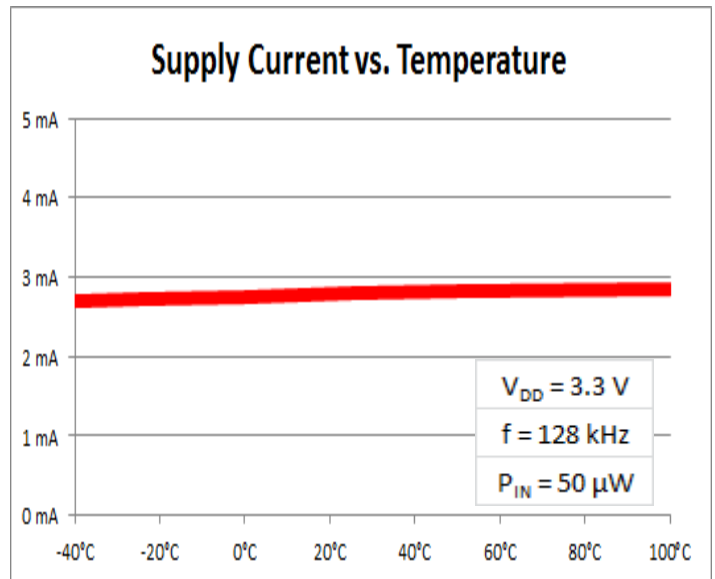
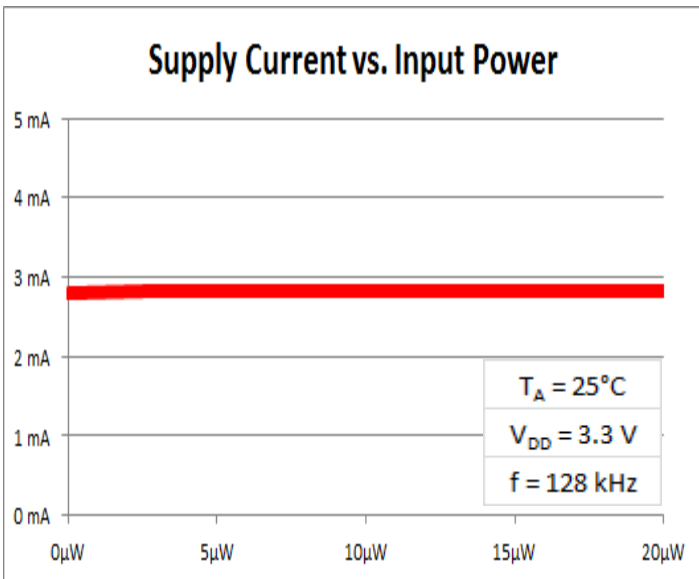
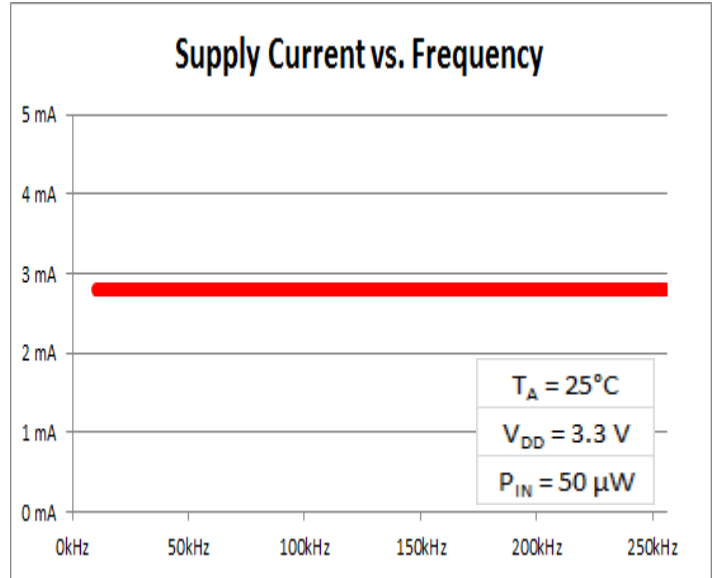
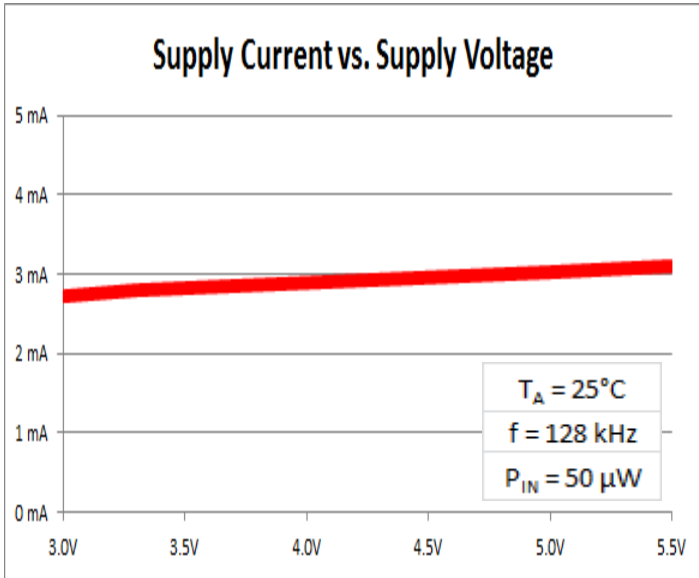

General Note

TT Electronics reserves the right to make changes in product specification without notice or liability. All information is subject to TT Electronics' own data and is considered accurate at time of going to print.



1645 Wallace Drive, Carrollton, TX 75006 | Ph: +1 972 323 2200
www.optekinc.com | www.ttelectronics.com

Rise/Fall Time

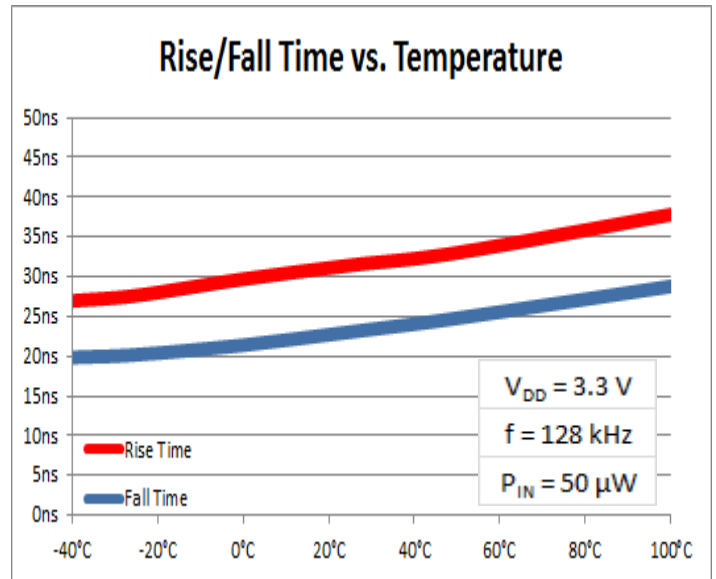
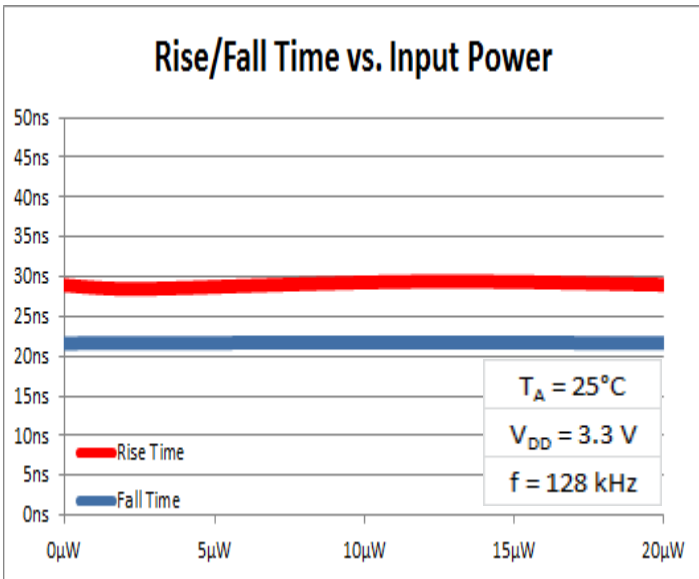
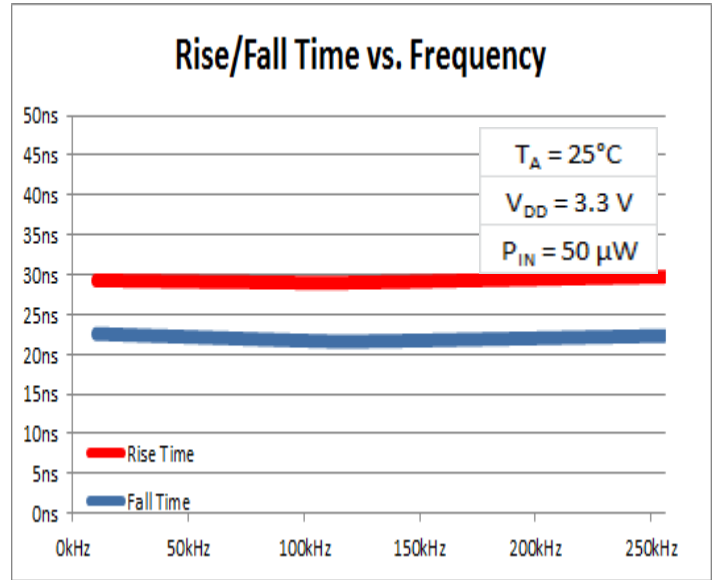
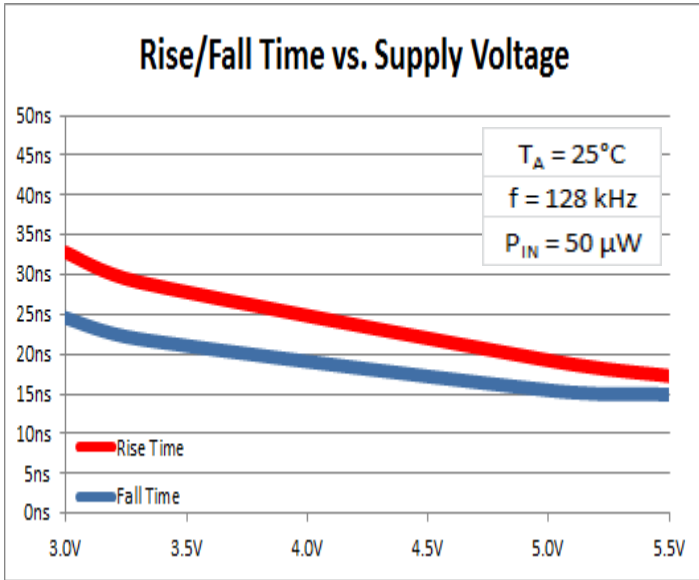

General Note

TT Electronics reserves the right to make changes in product specification without notice or liability. All information is subject to TT Electronics' own data and is considered accurate at time of going to print.



1645 Wallace Drive, Carrollton, TX 75006 | Ph: +1 972 323 2200
www.optekinc.com | www.ttelectronics.com

Propagation Delay

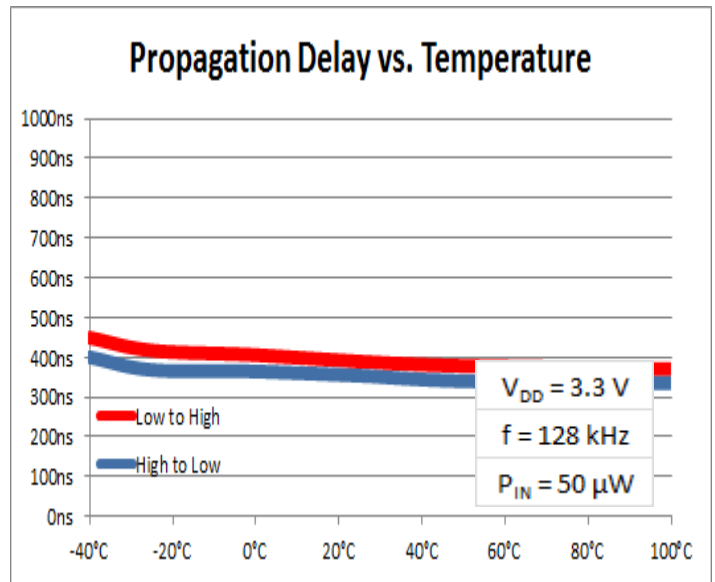
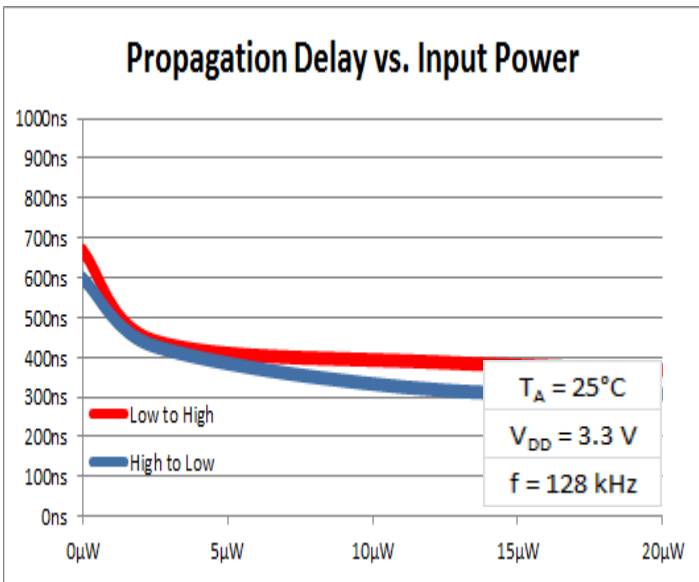
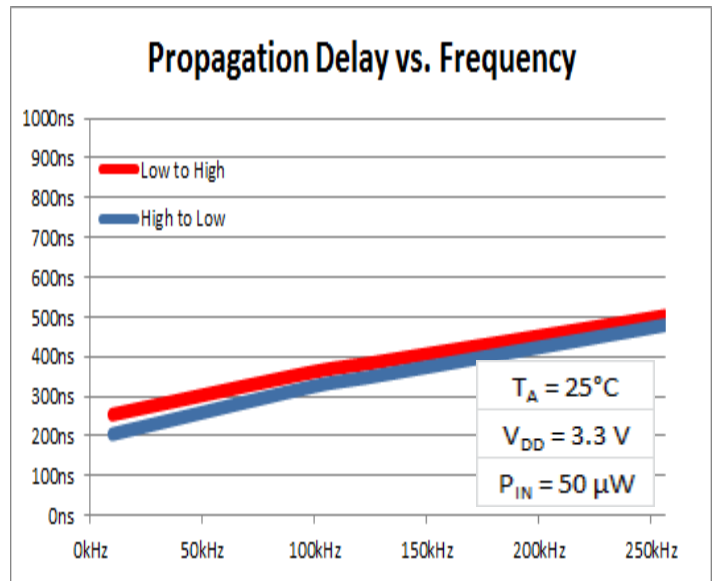
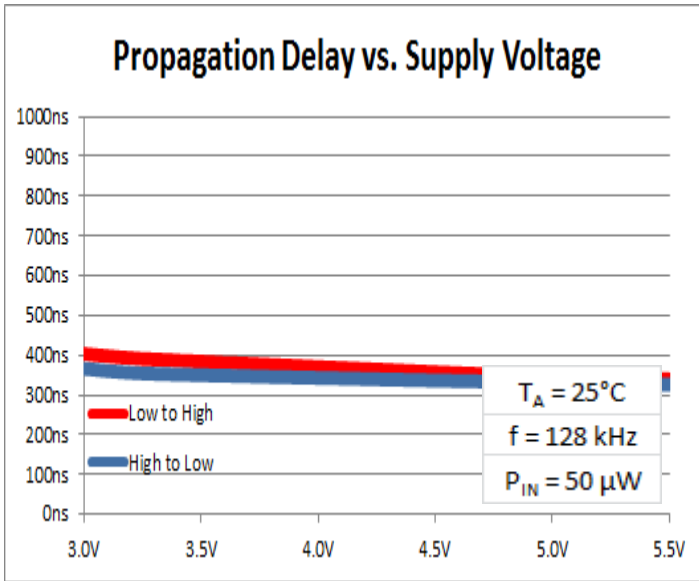

General Note

TT Electronics reserves the right to make changes in product specification without notice or liability. All information is subject to TT Electronics' own data and is considered accurate at time of going to print.



Pulse Width Distortion

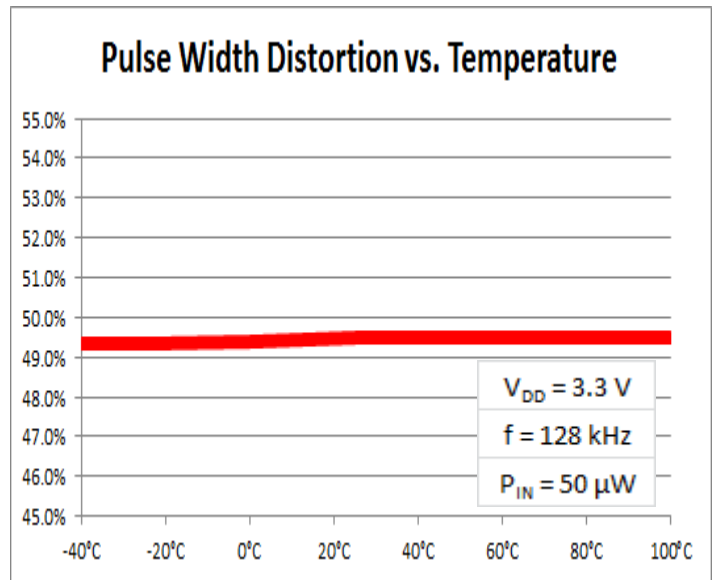
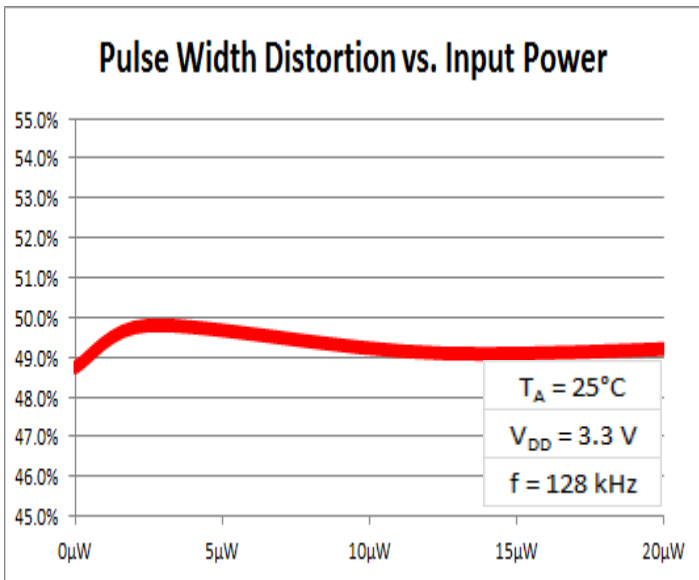
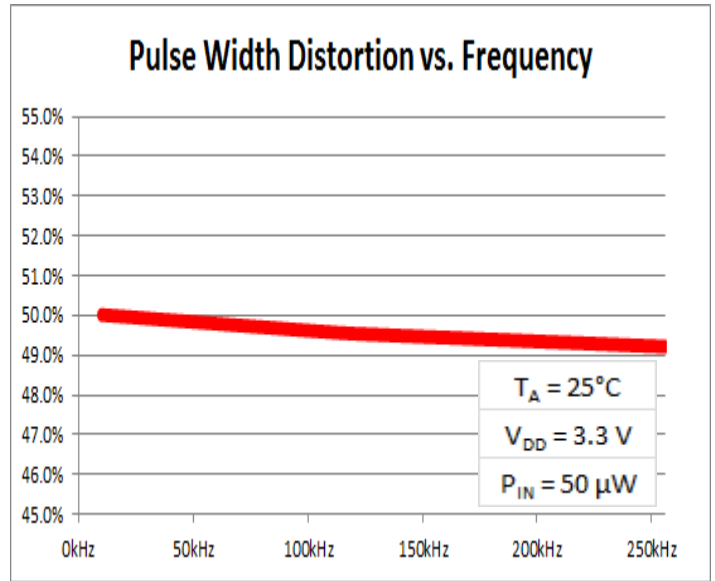
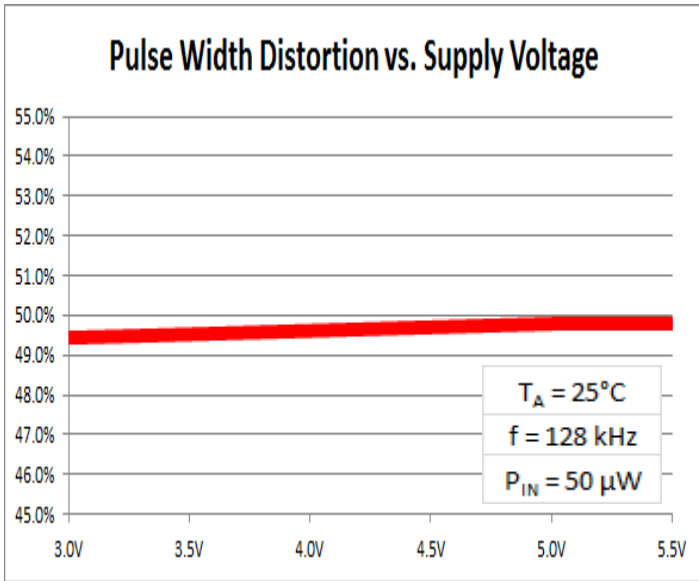

General Note

TT Electronics reserves the right to make changes in product specification without notice or liability. All information is subject to TT Electronics' own data and is considered accurate at time of going to print.



1645 Wallace Drive, Carrollton, TX 75006 | Ph: +1 972 323 2200
www.optekinc.com | www.ttelectronics.com

High and Low Level Output Voltage

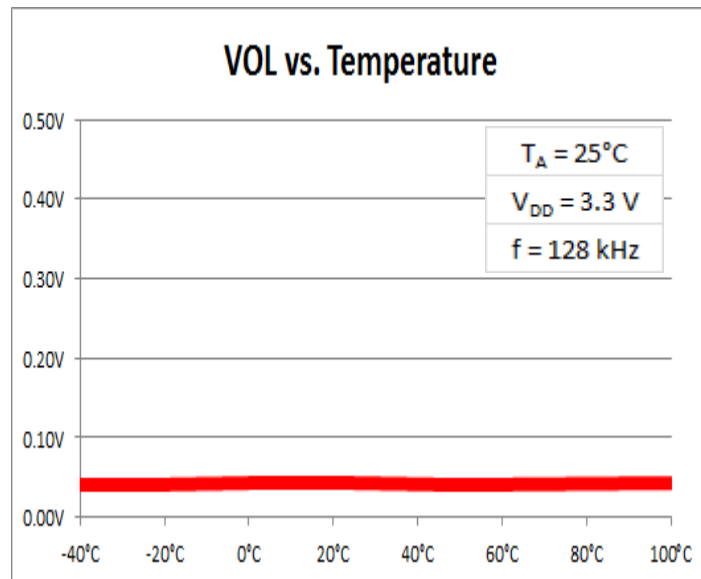
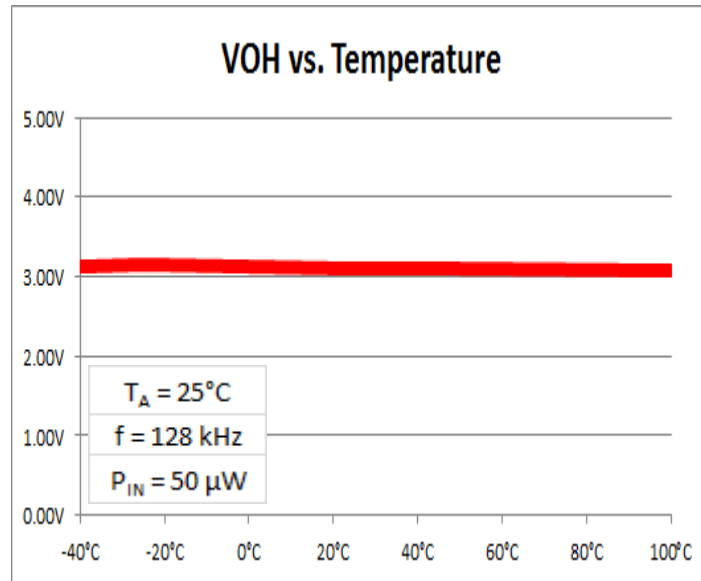

General Note

TT Electronics reserves the right to make changes in product specification without notice or liability. All information is subject to TT Electronics' own data and is considered accurate at time of going to print.



1645 Wallace Drive, Carrollton, TX 75006 | Ph: +1 972 323 2200
www.optekinc.com | www.ttelectronics.com

Sensitivity

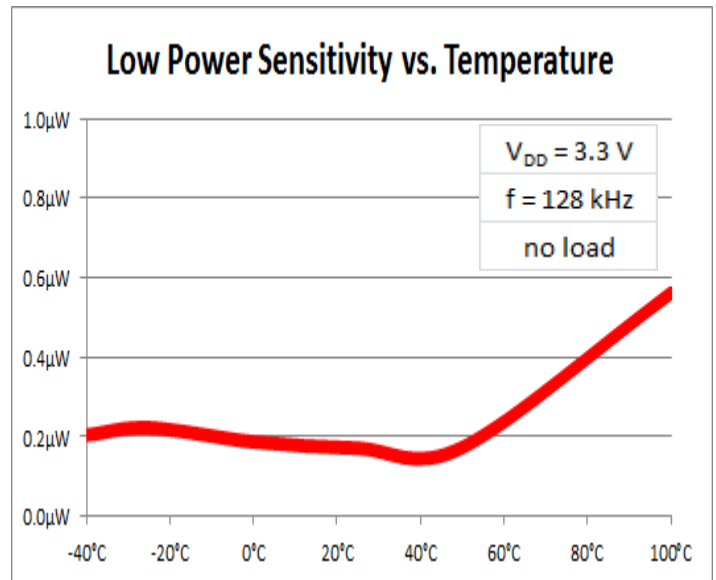
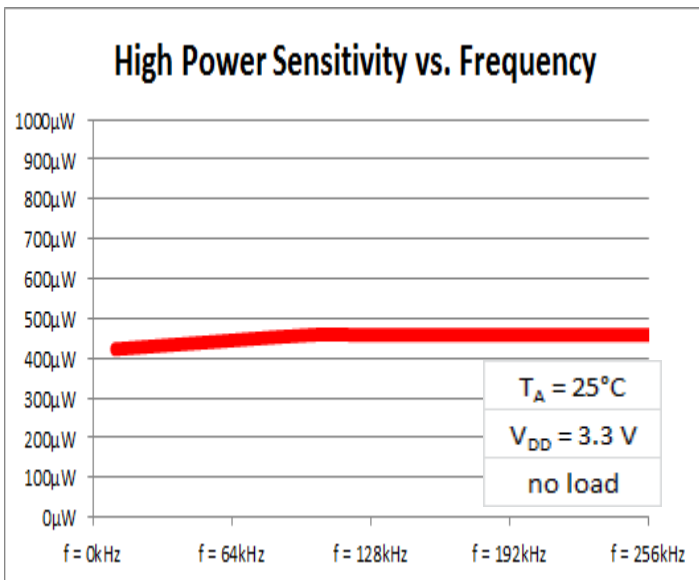
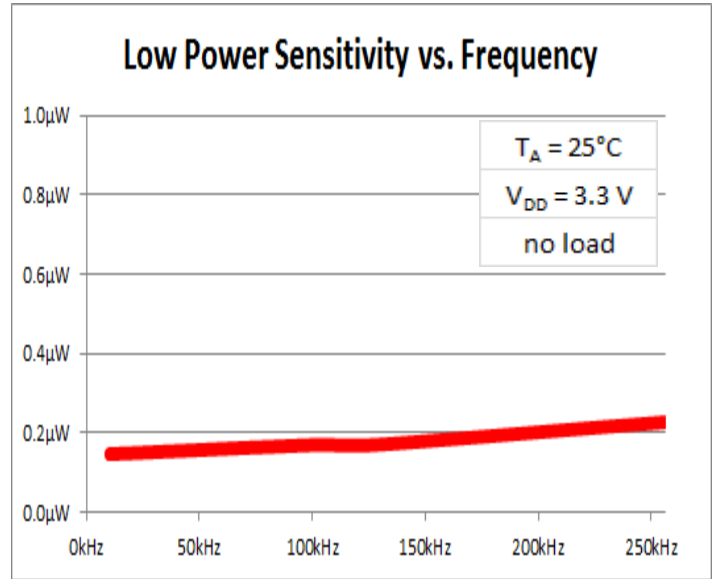
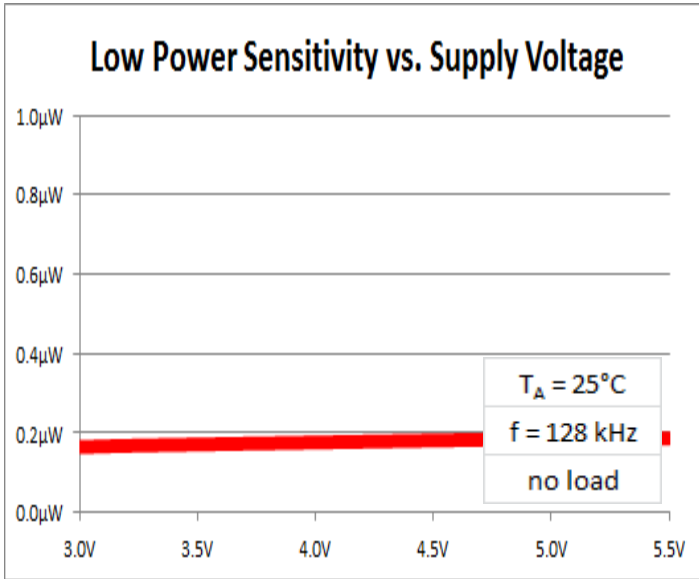

General Note

TT Electronics reserves the right to make changes in product specification without notice or liability. All information is subject to TT Electronics' own data and is considered accurate at time of going to print.



1645 Wallace Drive, Carrollton, TX 75006 | Ph: +1 972 323 2200
www.optekinc.com | www.ttelectronics.com

Frequency Response

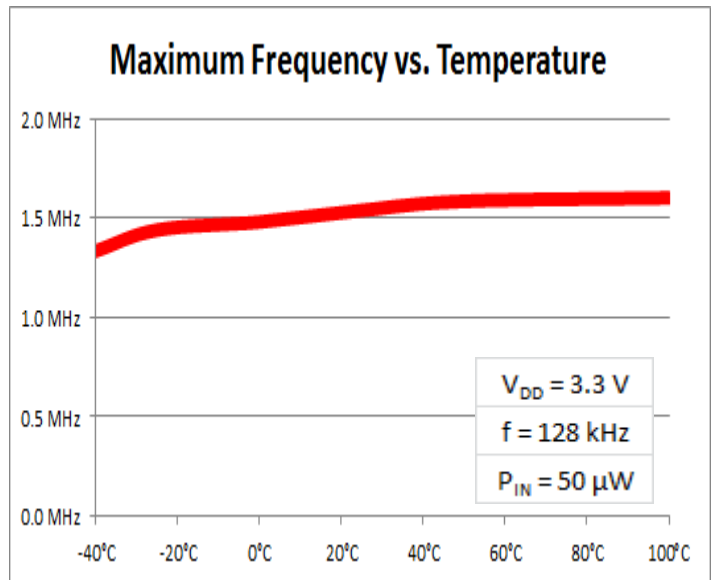
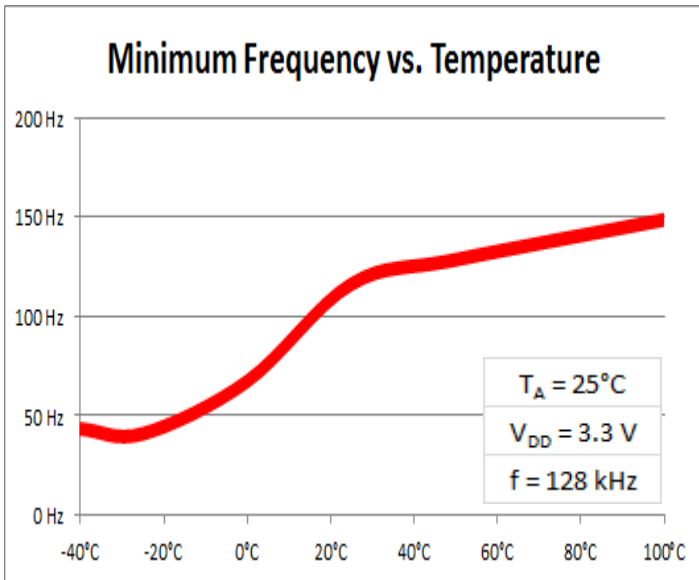
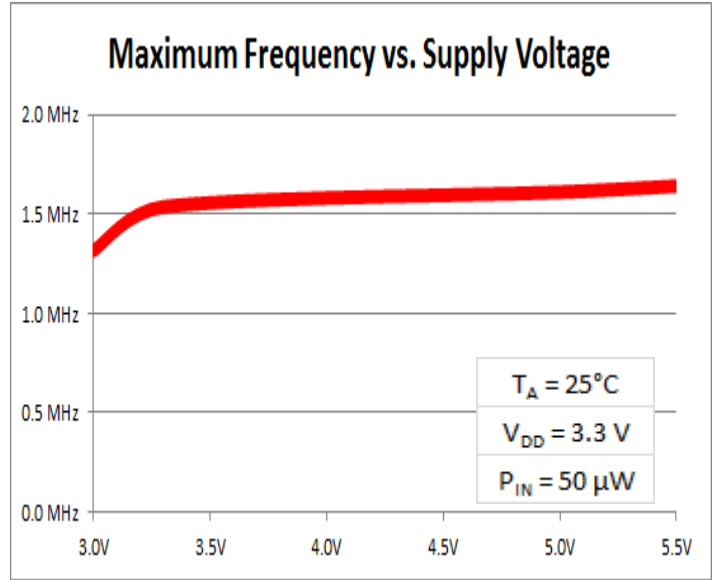
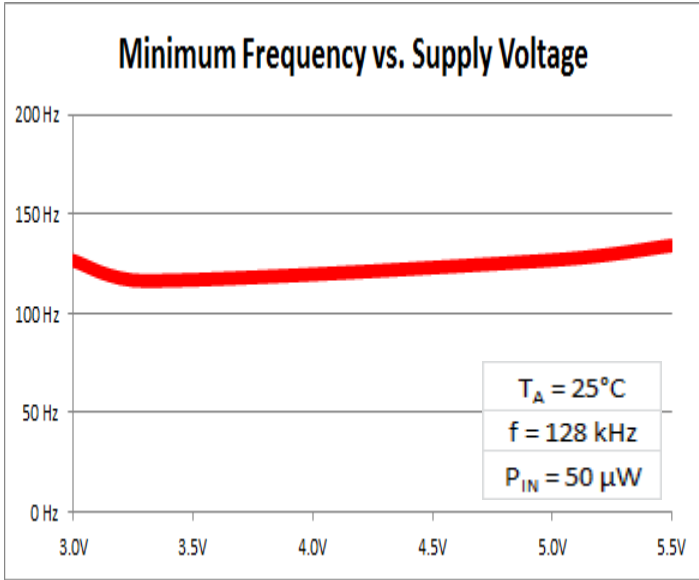

General Note

TT Electronics reserves the right to make changes in product specification without notice or liability. All information is subject to TT Electronics' own data and is considered accurate at time of going to print.



1645 Wallace Drive, Carrollton, TX 75006 | Ph: +1 972 323 2200
www.optekinc.com | www.ttelectronics.com

SMD Receiver Component

OPL6000

Packaging

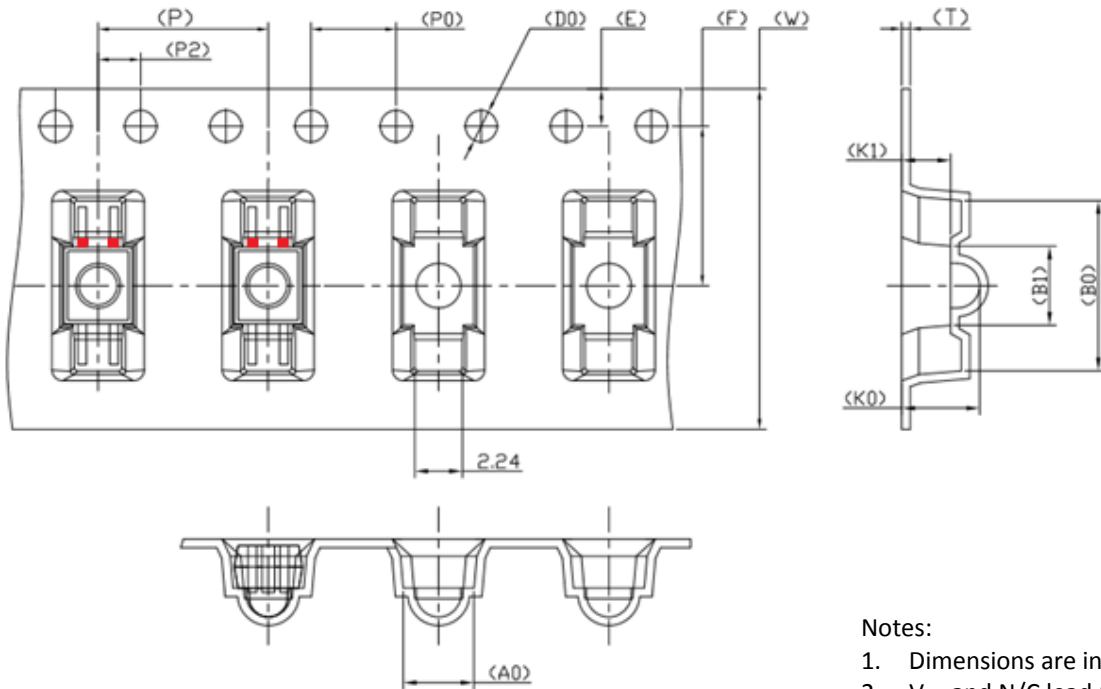

Notes:

1. Dimensions are in mm.
2. V_{DD} and N/C lead (marked with red stripe) is nearest sprocket holes.

W	16.00±0.30	P	8.00±0.10	A0	3.33±0.10	B0	8.00±0.10
E	1.75±0.10	P0	4.00±0.10	K0	3.66±0.10	B1	3.73±0.10
F	7.50±0.10	P2	2.00±0.10	K1	2.30±0.10		
T	0.40±0.05	D0	∅1.50 ^{+0.10} _{-0.00}				

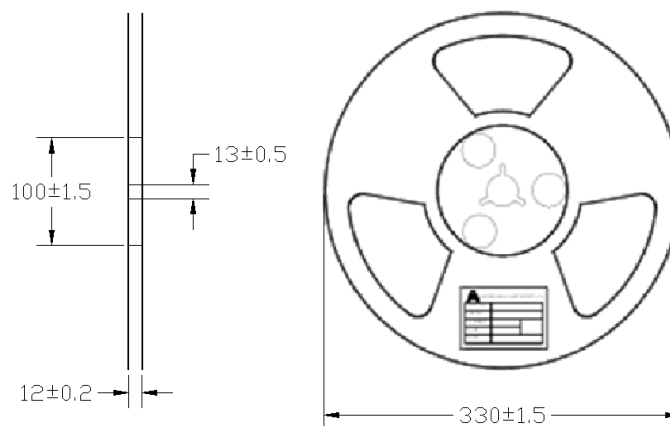

General Note

TT Electronics reserves the right to make changes in product specification without notice or liability. All information is subject to TT Electronics' own data and is considered accurate at time of going to print.