

MMBT4403-G (PNP) RoHS Device

Features

- Epitaxial planar die construction.
- Ideal for medium power amplification and switching.

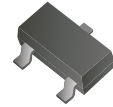

Mechanical data

- Case: SOT-23, molded plastic.
- Terminals: Solderable per MIL-STD-750, method 2026.
- Approx. weight: 0.008 grams(approx.).

Diagram:

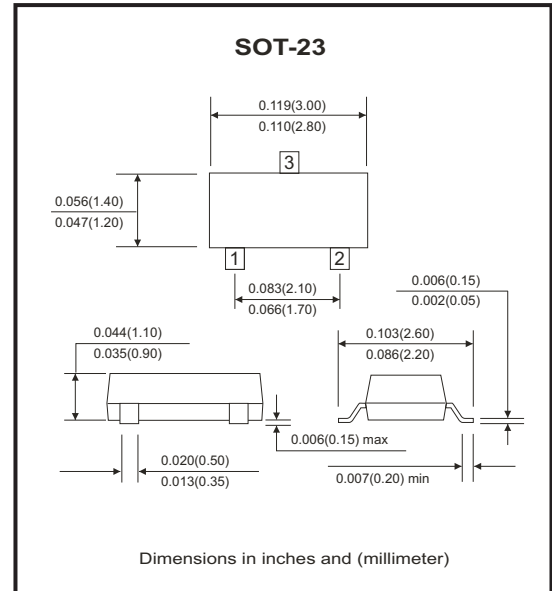
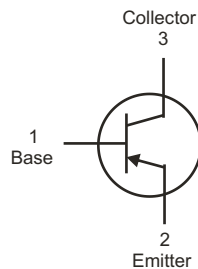

Maximum Ratings (at TA=25°C unless otherwise noted)

Parameter	Symbol	Value	Unit
Collector-Base voltage	V _{CB0}	-40	V
Collector-Emitter voltage	V _{CE0}	-40	V
Emitter-Base voltage	V _{EB0}	-5	V
Collector current	I _c	-600	mA
Collector power dissipation	P _c	300	mW
Thermal resistance from junction to ambient	R _{θJA}	417	°C/W
Junction temperature	T _J	150	°C
Storage temperature range	T _{STG}	-55 to +150	°C

Electrical Characteristics (at $T_A=25^\circ\text{C}$ unless otherwise noted)

Parameter	Symbol	Conditions	Min.	Typ.	Max.	Unit
Collector-Base breakdown voltage	$V_{(BR)CBO}$	$I_C=-100\mu\text{A}, I_E=0$	-40			V
Collector-Emitter breakdown voltage	$V_{(BR)CEO}$	$I_C=-1\text{mA}, I_B=0$	-40			V
Emitter-Base breakdown voltage	$V_{(BR)EBO}$	$I_E=-100\mu\text{A}, I_C=0$	-5			V
Collector cut-off current	I_{CBO}	$V_{CB}=-35\text{V}, I_E=0$			-0.1	μA
Collector cut-off current	I_{CEX}	$V_{CE}=-35\text{V}, V_{BE}=0.4\text{V}$			-0.1	μA
Emitter cut-off current	I_{EBO}	$V_{EB}=-4\text{V}, I_C=0$			-0.1	μA
DC current gain	h_{FE1}	$V_{CE}=-1\text{V}, I_C=-0.1\text{mA}$	30			
	h_{FE2}	$V_{CE}=-1\text{V}, I_C=-1\text{mA}$	60			
	h_{FE3}	$V_{CE}=-1\text{V}, I_C=-10\text{mA}$	100			
	h_{FE4}	$V_{CE}=-2\text{V}, I_C=-150\text{mA}$	100		300	
	h_{FE5}	$V_{CE}=-2\text{V}, I_C=-500\text{mA}$	20			
Collector-Emitter saturation voltage	$V_{CE(SAT)}$	$I_C=-150\text{mA}, I_B=-15\text{mA}$			-0.4	V
		$I_C=-500\text{mA}, I_B=-50\text{mA}$			-0.75	V
Base-Emitter saturation voltage	$V_{BE(SAT)}$	$I_C=-150\text{mA}, I_B=-15\text{mA}$			-0.95	V
		$I_C=-500\text{mA}, I_B=-50\text{mA}$			-1.30	V
Transition frequency	f_T	$V_{CE}=-10\text{V}, I_C=-20\text{mA}$ $f=100\text{MHz}$	200			MHz
Delay time	t_d	$V_{CC}=-30\text{V}, V_{BE(off)}=-0.5\text{V}$			15	ns
Rise time	t_r	$I_C=-150\text{mA}, I_{B1}=-15\text{mA}$			20	ns
Storage time	t_s	$V_{CC}=-30\text{V}, I_C=-150\text{mA}$			225	ns
Fall time	t_f	$I_{B1}=I_{B2}=-15\text{mA}$			60	ns

Rating And Characteristic Curves (MMBT4403-G)

Fig.1 - Static Characteristic

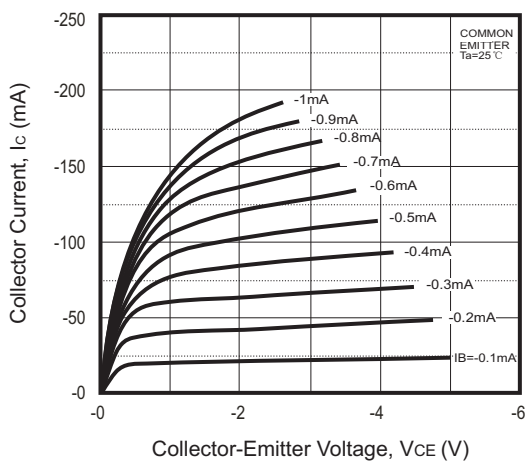
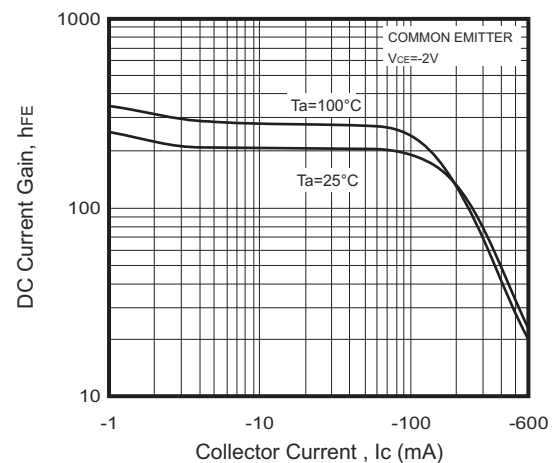

Fig.2 - $h_{FE} - I_C$



Rating And Characteristic Curves (MMBT4403-G)

Fig.3 - $V_{CEsat} - I_c$

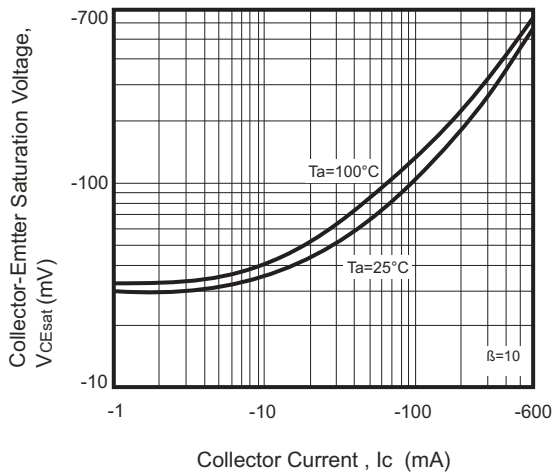

Fig.4 - $V_{BEsat} - I_c$

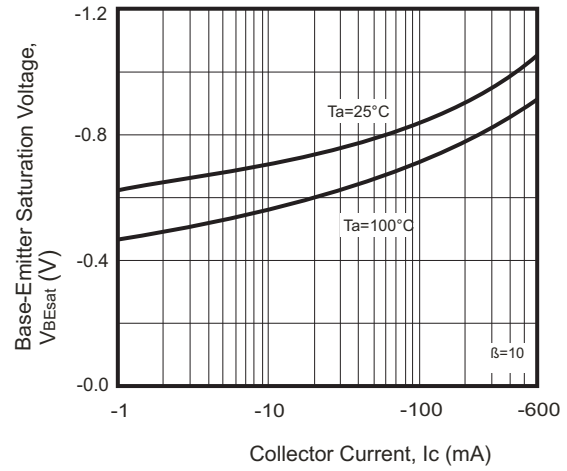

Fig.5 - $I_c - V_{BE}$

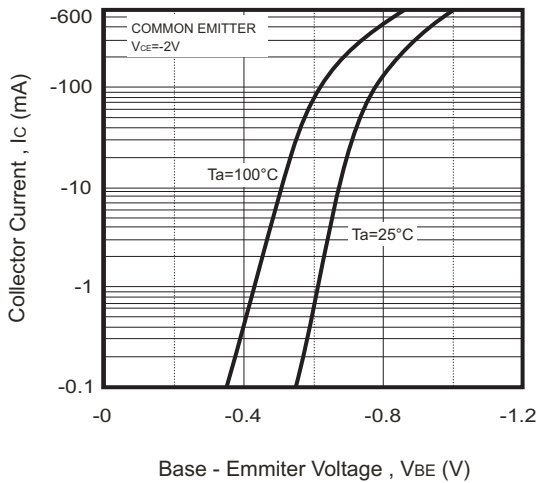

Fig.6 - $C_{ob}/C_{ib} - V_{CB}/V_{EB}$

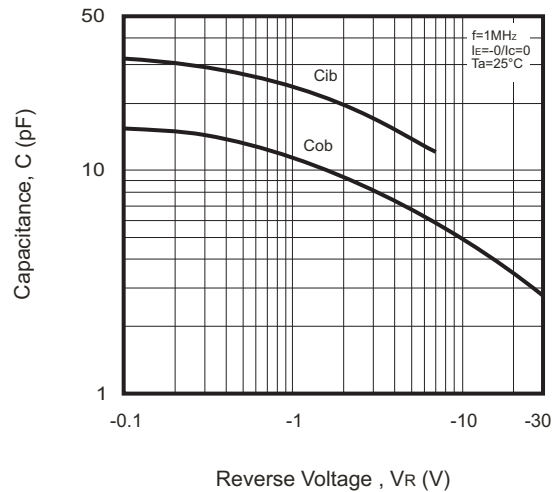

Fig.7 - $f_r - I_c$

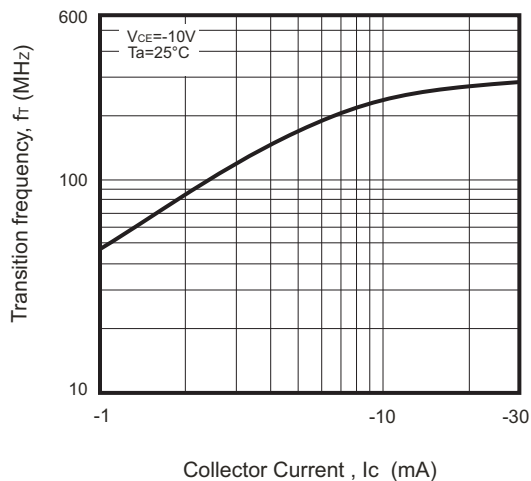
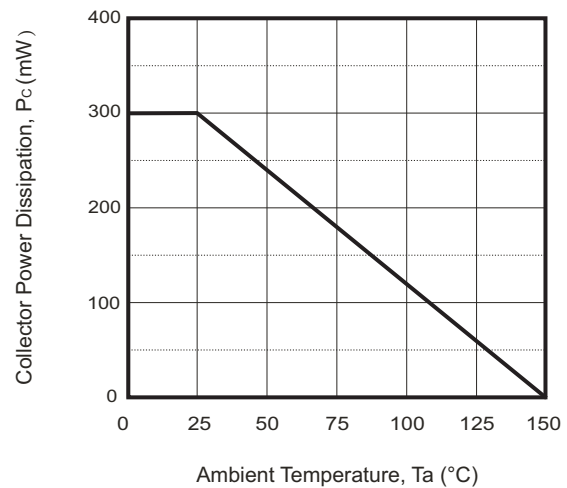
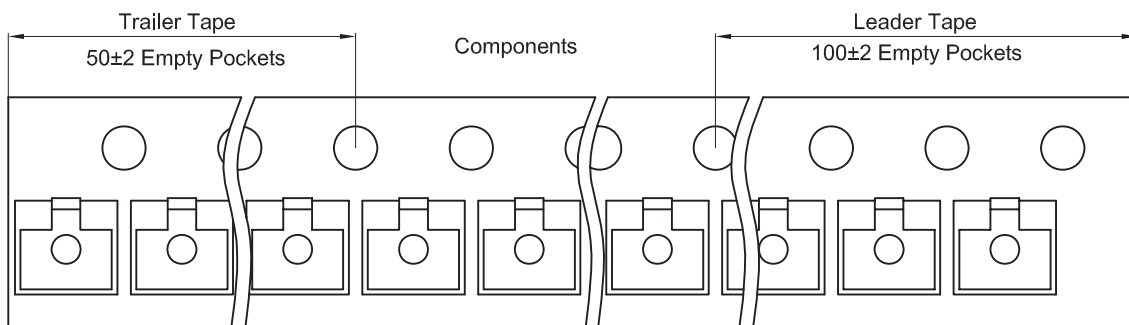
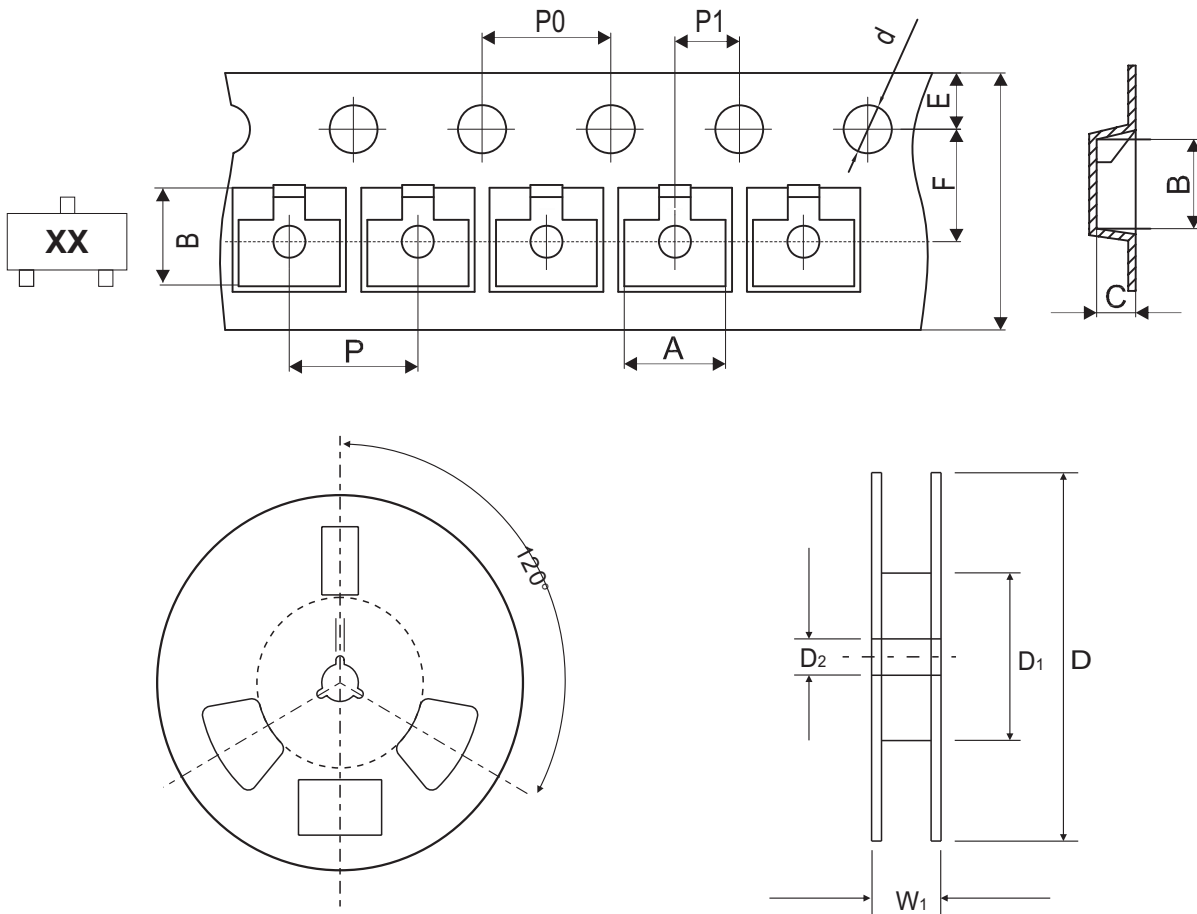

Fig.8 - $P_c - T_a$



Reel Taping Specification



SOT-23	SYMBOL	A	B	C	d	D	D1	D2
	(mm)	3.15 ± 0.10	2.77 ± 0.10	1.22 ± 0.10	1.50 ± 0.10	178.00 ± 2.00	54.40 ± 1.00	13.00 ± 1.00
	(inch)	0.124 ± 0.004	0.109 ± 0.004	0.048 ± 0.004	0.059 ± 0.004	7.008 ± 0.079	2.142 ± 0.039	0.512 ± 0.039

SOT-23	SYMBOL	E	F	P	P0	P1	W	W1
	(mm)	1.75 ± 0.10	3.50 ± 0.10	4.00 ± 0.10	4.00 ± 0.10	2.00 ± 0.10	8.00 + 0.30 / - 0.10	12.30 ± 1.00
	(inch)	0.069 ± 0.004	0.138 ± 0.004	0.157 ± 0.004	0.157 ± 0.004	0.079 ± 0.004	0.315 + 0.012 / - 0.004	0.484 ± 0.039

Marking Code

Part Number	Marking Code
MMBT4403-G	2T

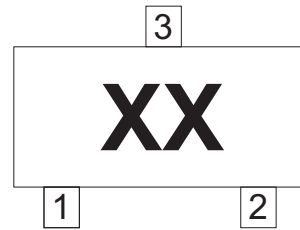

xx = Product type marking code

Suggested PAD Layout

SIZE	SOT-23	
	(mm)	(inch)
A	0.60	0.024
B	0.80	0.031
C	1.90	0.075
D	2.02	0.080
E	2.82	0.111

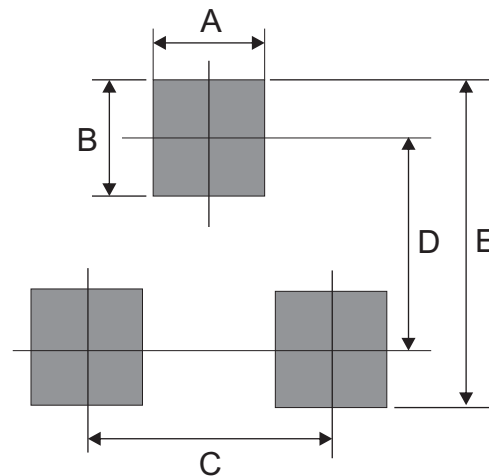

Standard Packaging

Case Type	Qty Per Reel	Reel Size
	(Pcs)	(inch)
SOT-23	3,000	7