

- Rugged Triple-Diffused Planar Construction
- 4 A Continuous Collector Current
- Operating Characteristics Fully Guaranteed at 100°C
- 1000 Volt Blocking Capability
- 75 W at 25°C Case Temperature

TO-220 PACKAGE  
(TOP VIEW)

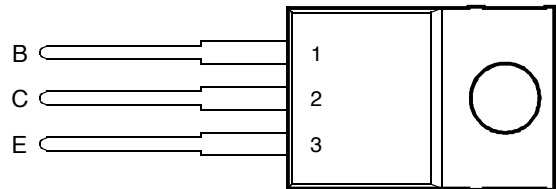

Pin 2 is in electrical contact with the mounting base.

MDTRACA



This series is obsolete and not recommended for new designs.

**absolute maximum ratings at 25°C case temperature (unless otherwise noted)**

RATING		SYMBOL	VALUE	UNIT
Collector-base voltage ( $I_E = 0$ )	TIPL760	$V_{CB0}$	850	V
	TIPL760A		1000	
Collector-emitter voltage ( $V_{BE} = 0$ )	TIPL760	$V_{CES}$	850	V
	TIPL760A		1000	
Collector-emitter voltage ( $I_B = 0$ )	TIPL760	$V_{CEO}$	400	V
	TIPL760A		450	
Emitter-base voltage		$V_{EBO}$	10	V
Continuous collector current		$I_C$	4	A
Peak collector current (see Note 1)		$I_{CM}$	8	A
Continuous device dissipation at (or below) 25°C case temperature		$P_{tot}$	75	W
Operating junction temperature range		$T_j$	-65 to +150	°C
Storage temperature range		$T_{stg}$	-65 to +150	°C

NOTE 1: This value applies for  $t_p \leq 10$  ms, duty cycle  $\leq 2\%$ .

**PRODUCT INFORMATION**

AUGUST 1978 - REVISED SEPTEMBER 2002  
Specifications are subject to change without notice.

**electrical characteristics at 25°C case temperature (unless otherwise noted)**

PARAMETER	TEST CONDITIONS			MIN	TYP	MAX	UNIT
$V_{CE(sus)}$ Collector-emitter sustaining voltage	$I_C = 10 \text{ mA}$	$L = 25 \text{ mH}$	(see Note 2)	TIPL760 TIPL760A	400 450		V
$I_{CES}$ Collector-emitter cut-off current	$V_{CE} = 850 \text{ V}$	$V_{BE} = 0$		TIPL760		50	$\mu\text{A}$
	$V_{CE} = 1000 \text{ V}$	$V_{BE} = 0$		TIPL760A		50	
	$V_{CE} = 850 \text{ V}$	$V_{BE} = 0$	$T_C = 100^\circ\text{C}$	TIPL760		200	
	$V_{CE} = 1000 \text{ V}$	$V_{BE} = 0$	$T_C = 100^\circ\text{C}$	TIPL760A		200	
$I_{CEO}$ Collector cut-off current	$V_{CE} = 400 \text{ V}$	$I_B = 0$		TIPL760		50	$\mu\text{A}$
	$V_{CE} = 450 \text{ V}$	$I_B = 0$		TIPL760A		50	
$I_{EBO}$ Emitter cut-off current	$V_{EB} = 10 \text{ V}$	$I_C = 0$				1	mA
$h_{FE}$ Forward current transfer ratio	$V_{CE} = 5 \text{ V}$	$I_C = 0.5 \text{ A}$	(see Notes 3 and 4)		20	60	
$V_{CE(sat)}$ Collector-emitter saturation voltage	$I_B = 0.5 \text{ A}$	$I_C = 2.5 \text{ A}$				1.0	V
	$I_B = 0.8 \text{ A}$	$I_C = 4 \text{ A}$	(see Notes 3 and 4)			2.5	
	$I_B = 0.8 \text{ A}$	$I_C = 4 \text{ A}$	$T_C = 100^\circ\text{C}$			5.0	
$V_{BE(sat)}$ Base-emitter saturation voltage	$I_B = 0.5 \text{ A}$	$I_C = 2.5 \text{ A}$				1.2	V
	$I_B = 0.8 \text{ A}$	$I_C = 4 \text{ A}$	(see Notes 3 and 4)			1.4	
	$I_B = 0.8 \text{ A}$	$I_C = 4 \text{ A}$	$T_C = 100^\circ\text{C}$			1.3	
$f_t$ Current gain bandwidth product	$V_{CE} = 10 \text{ V}$	$I_C = 0.5 \text{ A}$	$f = 1 \text{ MHz}$		12		MHz
$C_{ob}$ Output capacitance	$V_{CB} = 20 \text{ V}$	$I_E = 0$	$f = 0.1 \text{ MHz}$		110		pF

NOTES: 2. Inductive loop switching measurement.

3. These parameters must be measured using pulse techniques,  $t_p = 300 \mu\text{s}$ , duty cycle  $\leq 2\%$ .

4. These parameters must be measured using voltage-sensing contacts, separate from the current carrying contacts.

**thermal characteristics**

PARAMETER	MIN	TYP	MAX	UNIT
$R_{\theta JC}$ Junction to case thermal resistance			1.56	$^\circ\text{C/W}$

**inductive-load-switching characteristics at 25°C case temperature (unless otherwise noted)**

PARAMETER	TEST CONDITIONS †			MIN	TYP	MAX	UNIT
$t_{sv}$ Voltage storage time	$I_C = 4 \text{ A}$ $V_{BE(off)} = -5 \text{ V}$	$I_{B(on)} = 0.8 \text{ A}$	(see Figures 1 and 2)			2.5	$\mu\text{s}$
$t_{rv}$ Voltage rise time						300	ns
$t_{fi}$ Current fall time						250	ns
$t_{ti}$ Current tail time						150	ns
$t_{xo}$ Cross over time						400	ns
$t_{sv}$ Voltage storage time				$I_C = 4 \text{ A}$ $V_{BE(off)} = -5 \text{ V}$	$I_{B(on)} = 0.8 \text{ A}$	(see Figures 1 and 2)	
$t_{rv}$ Voltage rise time			500				ns
$t_{fi}$ Current fall time			250				ns
$t_{ti}$ Current tail time		$T_C = 100^\circ\text{C}$	150				ns
$t_{xo}$ Cross over time			750				ns

† Voltage and current values shown are nominal; exact values vary slightly with transistor parameters.

**PARAMETER MEASUREMENT INFORMATION**

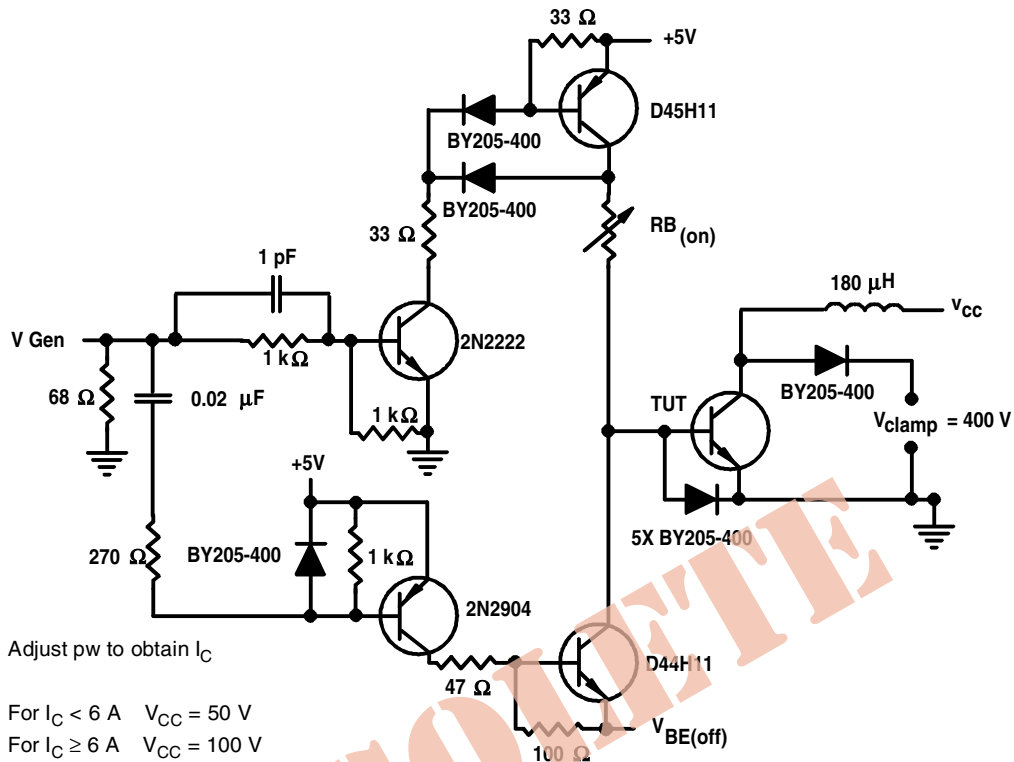

**Figure 1. Inductive-Load Switching Test Circuit**

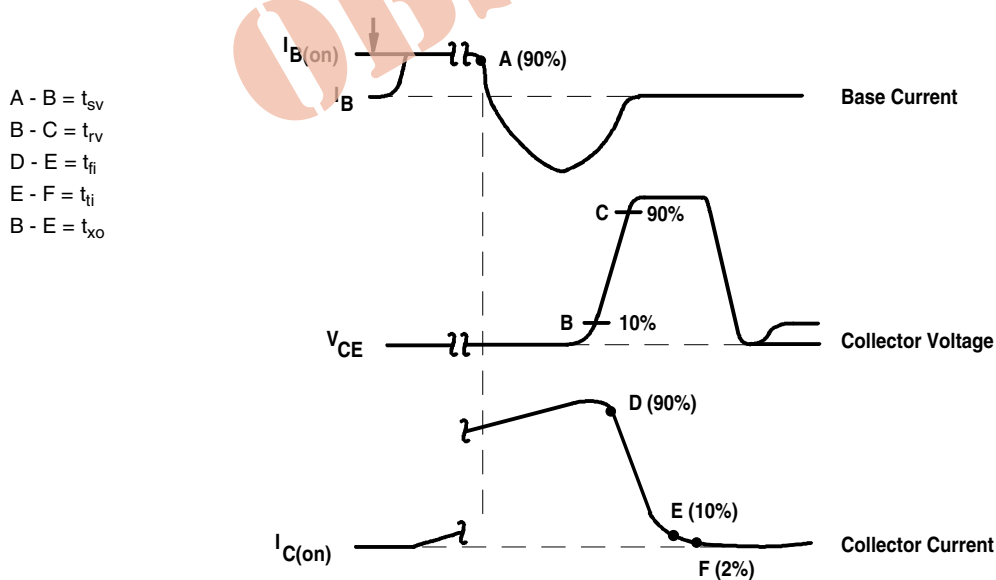

NOTES: A. Waveforms are monitored on an oscilloscope with the following characteristics:  $t_r < 15 \text{ ns}$ ,  $R_{in} > 10 \Omega$ ,  $C_{in} < 11.5 \text{ pF}$ .  
 B. Resistors must be noninductive types.

**Figure 2. Inductive-Load Switching Waveforms**

**PRODUCT INFORMATION**

TYPICAL CHARACTERISTICS

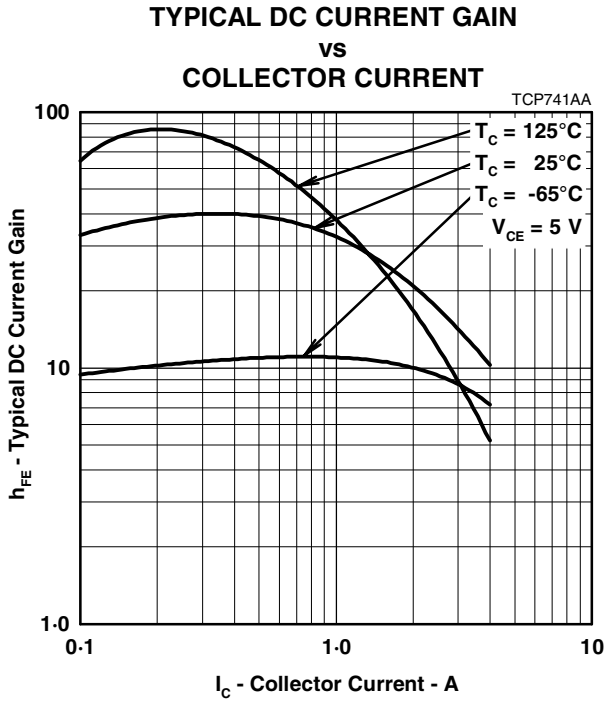

Figure 3.

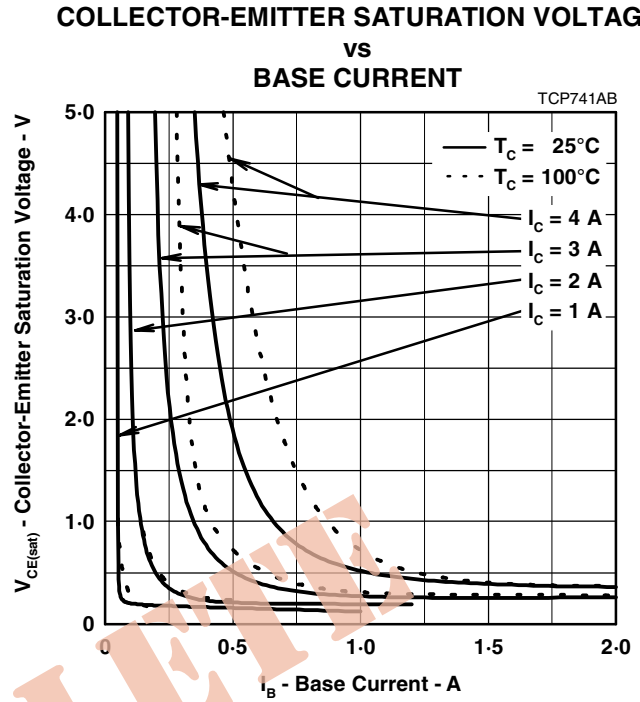

Figure 4.

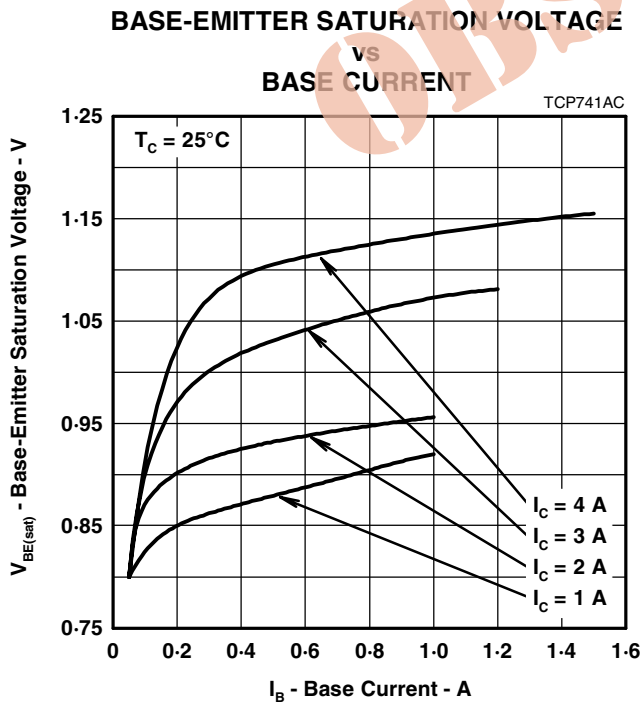

Figure 5.

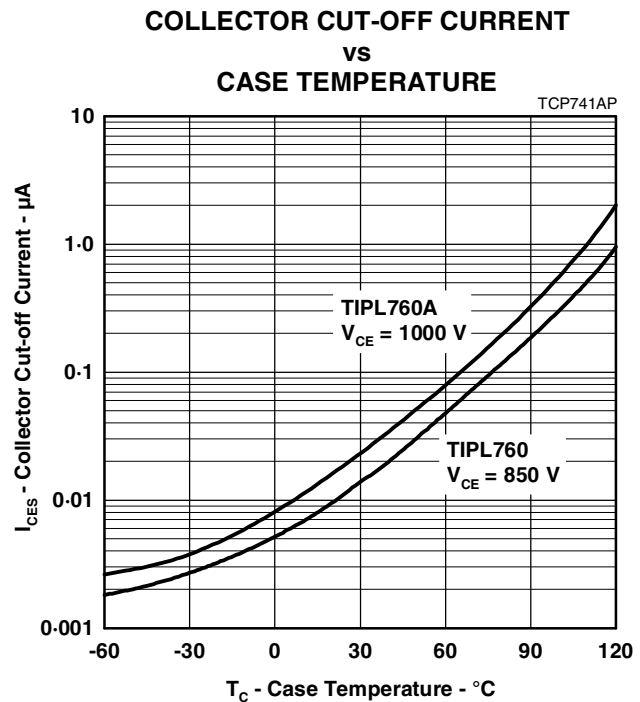

Figure 6.

**PRODUCT INFORMATION**

AUGUST 1978 - REVISED SEPTEMBER 2002  
Specifications are subject to change without notice.

**MAXIMUM SAFE OPERATING REGIONS**

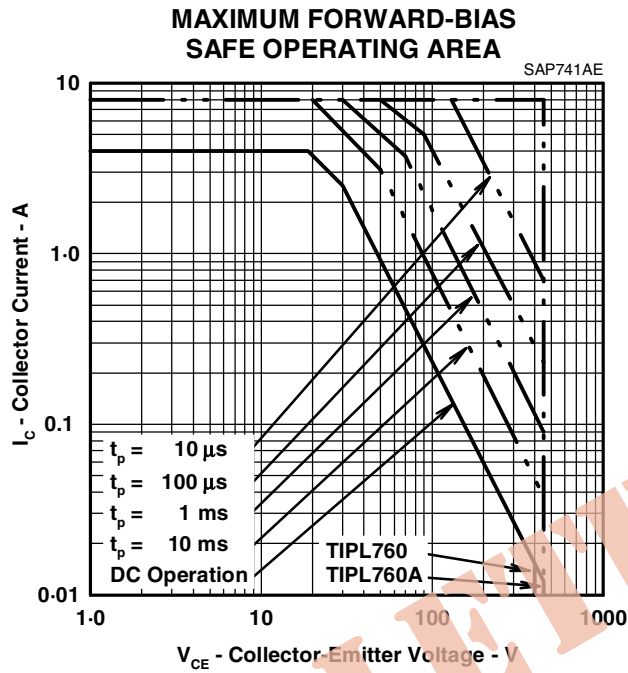

Figure 7.

**THERMAL INFORMATION**

**THERMAL RESPONSE JUNCTION TO CASE  
VS  
POWER PULSE DURATION**

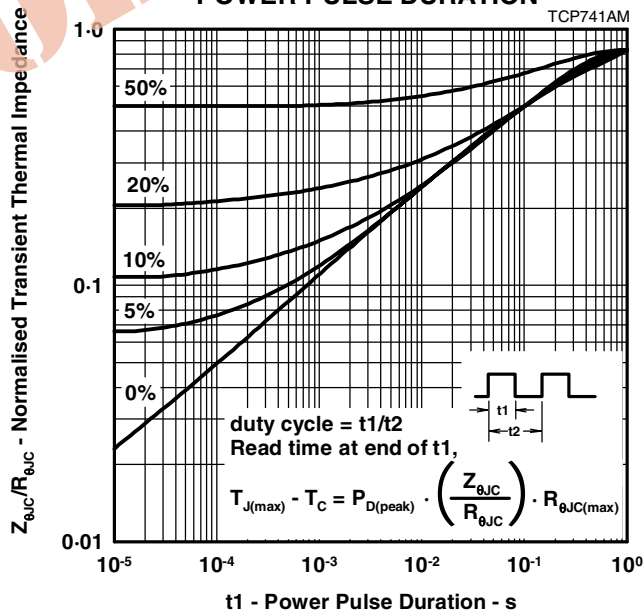

Figure 8.

**PRODUCT INFORMATION**

AUGUST 1978 - REVISED SEPTEMBER 2002  
 Specifications are subject to change without notice.